

BCP-350F- 3 BK - PCB connector



5452512

<https://www.phoenixcontact.com/us/products/5452512>

Please be informed that the data shown in this PDF document is generated from our online catalog. Please find the complete data in the user documentation. Our general terms of use for downloads are valid.



The figure shows a 5-pos. version of the product in gray

PCB connector, nominal cross section: 1.5 mm², color: black, nominal current: 8 A, rated voltage (III/2): 160 V, contact surface: Sn, contact connection type: Socket, number of potentials: 3, number of rows: 1, number of positions: 3, number of connections: 3, product range: BCP-F, pitch: 3.5 mm, connection method: Screw connection with tension sleeve, screw head form: L Slotted, conductor/PCB connection direction: 0 °, plug-in system: BASICLINE 1,5, locking: Screw locking mechanism, mounting method: Screw flange, type of packaging: packed in cardboard

Commercial data

| | |
|--------------------------------------|--------------------------------|
| Item number | 5452512 |
| Packing unit | 100 pc |
| Minimum order quantity | 100 pc |
| Note | Made to order (non-returnable) |
| Sales key | AA02 |
| Product key | AABAXB |
| GTIN | 4046356850698 |
| Weight per piece (including packing) | 2.823 g |
| Weight per piece (excluding packing) | 2.823 g |
| Customs tariff number | 85366990 |
| Country of origin | CN |

BCP-350F- 3 BK - PCB connector



5452512

<https://www.phoenixcontact.com/us/products/5452512>

Technical data

Product properties

| | |
|-----------------------|-----------------------|
| Product type | PCB connector |
| Product family | BCP-F |
| Product line | COMBICON Connectors S |
| Type | Standard |
| Number of positions | 3 |
| Pitch | 3.5 mm |
| Number of connections | 3 |
| Number of rows | 1 |
| Number of potentials | 3 |
| Mounting type | Screw flange |

Electrical properties

Properties

| | |
|-----------------------------|--------|
| Nominal current I_N | 8 A |
| Nominal voltage U_N | 160 V |
| Contact resistance | 2 mΩ |
| Rated voltage (III/3) | 160 V |
| Rated surge voltage (III/3) | 2.5 kV |
| Rated voltage (III/2) | 160 V |
| Rated surge voltage (III/2) | 2.5 kV |
| Rated voltage (II/2) | 320 V |
| Rated surge voltage (II/2) | 2.5 kV |

Connection data

Connection technology

| | |
|-------------------------|---------------------|
| Type | Standard |
| Connector system | BASICLINE 1,5 |
| Nominal cross section | 1.5 mm ² |
| Contact connection type | Socket |

Interlock

| | |
|-------------------|-------------------------|
| Locking type | Screw locking mechanism |
| Mounting type | Screw flange |
| Tightening torque | 0.3 Nm |

Conductor connection

| | |
|------------------------------------|---|
| Connection method | Screw connection with tension sleeve |
| Conductor/PCB connection direction | 0 ° |
| Conductor cross-section rigid | 0.2 mm ² ... 1.5 mm ² |
| Conductor cross-section flexible | 0.2 mm ² ... 1.5 mm ² |

BCP-350F- 3 BK - PCB connector



5452512

<https://www.phoenixcontact.com/us/products/5452512>

| | |
|---|---|
| Conductor cross-section AWG | 24 ... 16 |
| Conductor cross-section, flexible, with ferrule, without plastic sleeve | 0.25 mm ² ... 1.5 mm ² |
| Conductor cross-section, flexible, with ferrule, with plastic sleeve | 0.25 mm ² ... 0.5 mm ² |
| 2 conductors with same cross section, rigid | 0.2 mm ² ... 0.5 mm ² |
| 2 conductors with same cross section, flexible | 0.2 mm ² ... 0.75 mm ² |
| 2 conductors with same cross section, flexible, with ferrule without plastic sleeve | 0.25 mm ² ... 0.34 mm ² |
| 2 conductors with the same cross section, flexible, with TWIN ferrule with plastic sleeve | 0.5 mm ² ... 0.5 mm ² |
| Cylindrical gauge a x b / diameter | 2.4 mm x 1.5 mm / 1.6 mm |
| Stripping length | 7 mm |
| Drive form screw head | Slotted (L) |
| Tightening torque | 0.22 Nm ... 0.25 Nm |

Material specifications

Material data - contact

| | |
|--|--|
| Note | WEEE/RoHS-compliant, free of whiskers according to IEC 60068-2-82/JEDEC JESD 201 |
| Contact material | Cu alloy |
| Surface characteristics | hot-dip tin-plated |
| Metal surface terminal point (top layer) | Tin (4 µm - 8 µm Sn) |
| Metal surface contact area (top layer) | Tin (4 µm - 8 µm Sn) |

Material data - housing

| | |
|---|--------------|
| Color (Housing) | black (9005) |
| Insulating material | PA |
| Insulating material group | I |
| CTI according to IEC 60112 | 600 |
| Flammability rating according to UL 94 | V0 |
| Glow wire flammability index GWFI according to EN 60695-2-12 | 850 |
| Glow wire ignition temperature GWIT according to EN 60695-2-13 | 775 |
| Temperature for the ball pressure test according to EN 60695-10-2 | 125 °C |

Dimensions

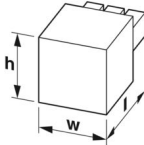
| | |
|---------------------|--|
| Dimensional drawing |  |
| Pitch | 3.5 mm |
| Width [w] | 20.8 mm |
| Height [h] | 11.1 mm |

BCP-350F- 3 BK - PCB connector



5452512

<https://www.phoenixcontact.com/us/products/5452512>

| | |
|------------|---------|
| Length [l] | 16.1 mm |
|------------|---------|

Mounting

Flange

| | |
|-------------------|--------|
| Tightening torque | 0.3 Nm |
|-------------------|--------|

Mechanical tests

Test for conductor damage and slackening

| | |
|---------------|---------------------|
| Specification | IEC 60999-1:1999-11 |
| Result | Test passed |

Pull-out test

| | |
|---|---|
| Specification | IEC 60999-1:1999-11 |
| Conductor cross-section/conductor type/tractive force setpoint/actual value | 0.2 mm ² / solid / > 10 N |
| | 0.2 mm ² / flexible / > 10 N |
| | 1.5 mm ² / solid / > 40 N |
| | 1.5 mm ² / flexible / > 40 N |

Insertion and withdrawal forces

| | |
|-------------------------------------|---------------------|
| Specification | IEC 60512-7:1993-08 |
| Result | Test passed |
| No. of cycles | 25 |
| Insertion strength per pos. approx. | 7 N |
| Withdraw strength per pos. approx. | 4 N |

Torque test

| | |
|---------------|---------------------|
| Specification | IEC 60999-1:1999-11 |
|---------------|---------------------|

Resistance of inscriptions

| | |
|---------------|------------------------|
| Specification | IEC 60068-2-70:1995-12 |
| Result | Test passed |

Polarization and coding

| | |
|---------------|------------------------------------|
| Specification | IEC 60512-7:1993-08 (Polarization) |
| Result | Test passed |

Visual inspection

| | |
|---------------|-----------------------|
| Specification | IEC 60512-1-1:2002-02 |
| Result | Test passed |

Dimension check

| | |
|---------------|-----------------------|
| Specification | IEC 60512-1-2:2002-02 |
| Result | Test passed |

Environmental and real-life conditions

Durability test

BCP-350F- 3 BK - PCB connector



5452512

<https://www.phoenixcontact.com/us/products/5452512>

| | |
|--|---------------------|
| Specification | IEC 60512-5:1992-08 |
| Impulse withstand voltage at sea level | 2.95 kV |
| Contact resistance R ₁ | 2 mΩ |
| Contact resistance R ₂ | 2.5 mΩ |
| Insertion/withdrawal cycles | 25 |

Climatic test

| | |
|-----------------------------------|---|
| Specification | ISO 6988:1985-02 |
| Corrosive stress | 0.2 dm ³ SO ₂ on 300 dm ³ /40 °C/1 cycle |
| Thermal stress | 100 °C/168 h |
| Power-frequency withstand voltage | 1.39 kV |

Vibration test

| | |
|------------------------|-----------------------------|
| Specification | IEC 60068-2-6:1995-03 |
| Frequency | 10 - 150 - 10 Hz |
| Sweep speed | 1 octave/min |
| Amplitude | 0.35 mm (10 Hz ... 60.1 Hz) |
| Acceleration | 5g (60.1 Hz ... 150 Hz) |
| Test duration per axis | 2.5 h |
| Test directions | X-, Y- and Z-axis |

Ambient conditions

| | |
|---|---|
| Ambient temperature (storage/transport) | -40 °C ... 70 °C |
| Relative humidity (storage/transport) | 30 % ... 70 % |
| Ambient temperature (assembly) | -5 °C ... 100 °C |
| Ambient temperature (operation) | -40 °C ... 100 °C (dependent on the derating curve) |

Electrical tests

Thermal test | Test group C

| | |
|----------------------------|-----------------------|
| Specification | IEC 60512-5-1:2002-02 |
| Tested number of positions | 20 |

Insulation resistance

| | |
|--|-----------------------|
| Specification | IEC 60512-3-1:2002-02 |
| Insulation resistance, neighboring positions | 10 ¹² Ω |

Air clearances and creepage distances |

| | |
|--|---------------------|
| Specification | IEC 60664-1:2007-04 |
| Insulating material group | I |
| Comparative tracking index (IEC 60112) | CTI 600 |
| Rated insulation voltage (III/3) | 160 V |
| Rated surge voltage (III/3) | 2.5 kV |
| minimum clearance value - non-homogenous field (III/3) | 1.5 mm |
| minimum creepage distance (III/3) | 2 mm |
| Rated insulation voltage (III/2) | 160 V |
| Rated surge voltage (III/2) | 2.5 kV |

BCP-350F- 3 BK - PCB connector



5452512

<https://www.phoenixcontact.com/us/products/5452512>

| | |
|--|--------|
| minimum clearance value - non-homogenous field (III/2) | 1.5 mm |
| minimum creepage distance (III/2) | 1.5 mm |
| Rated insulation voltage (II/2) | 320 V |
| Rated surge voltage (II/2) | 2.5 kV |
| minimum clearance value - non-homogenous field (II/2) | 1.5 mm |
| minimum creepage distance (II/2) | 1.6 mm |

Packaging specifications

| | |
|-------------------|---------------------|
| Type of packaging | packed in cardboard |
|-------------------|---------------------|

BCP-350F- 3 BK - PCB connector

5452512

<https://www.phoenixcontact.com/us/products/5452512>

Drawings

Dimensional drawing



Diagram



Type: BCP-350F-... with BCH-350HF-...

BCP-350F- 3 BK - PCB connector



5452512

<https://www.phoenixcontact.com/us/products/5452512>



Type: BCP-350F-... with BCH-350VF-...

BCP-350F- 3 BK - PCB connector



5452512

<https://www.phoenixcontact.com/us/products/5452512>

Approvals

To download certificates, visit the product detail page: <https://www.phoenixcontact.com/us/products/5452512>

|  cULus Recognized Approval ID: E60425-20071007 | | | | |
|---|-----------------------|-----------------------|-------------------|-----------------------------|
| | Nominal voltage U_N | Nominal current I_N | Cross section AWG | Cross section mm^2 |
| B | 250 V | 8 A | 30 - 14 | - |
| D | 300 V | 8 A | 30 - 14 | - |

|  VDE report with production monitoring Approval ID: 40040694 | | | | |
|---|-----------------------|-----------------------|-------------------|-----------------------------|
| | Nominal voltage U_N | Nominal current I_N | Cross section AWG | Cross section mm^2 |
| keine | 160 V | 8 A | - | 0.2 - 1.5 |

BCP-350F- 3 BK - PCB connector



5452512

<https://www.phoenixcontact.com/us/products/5452512>

Classifications

ECLASS

| | |
|-------------|----------|
| ECLASS-13.0 | 27460202 |
| ECLASS-15.0 | 27460202 |

ETIM

| | |
|-----------|----------|
| ETIM 10.0 | EC002638 |
|-----------|----------|

UNSPSC

| | |
|-------------|----------|
| UNSPSC 21.0 | 39121400 |
|-------------|----------|

BCP-350F- 3 BK - PCB connector



5452512

<https://www.phoenixcontact.com/us/products/5452512>

Environmental product compliance

EU RoHS

| | |
|---|------|
| Fulfills EU RoHS substance requirements | Yes |
| Exemption | 6(c) |

China RoHS

| | |
|--|---|
| Environment friendly use period (EFUP) | EFUP-50 |
| | An article-related China RoHS declaration table can be found in the download area for the respective article under "Manufacturer declaration". For all articles with EFUP-E, no China RoHS declaration table issued and required. |

EU REACH SVHC

| | |
|-------------------------------------|----------------------|
| REACH candidate substance (CAS No.) | Lead(CAS: 7439-92-1) |
|-------------------------------------|----------------------|

Phoenix Contact 2026 © - all rights reserved
<https://www.phoenixcontact.com>

Phoenix Contact USA
586 Fulling Mill Road
Middletown, PA 17057, United States
(+717) 944-1300
info@phoenixcon.com