

# PTPOWER 95-3L/FE-F - High-current terminal block



3260127

<https://www.phoenixcontact.com/us/products/3260127>

Please be informed that the data shown in this PDF document is generated from our online catalog. Please find the complete data in the user documentation. Our general terms of use for downloads are valid.



High-current terminal block, Blocked, nom. voltage: 1000 V, nominal current: 232 A, number of connections: 8, number of positions: 4, connection method: PowerTurn connection, cross section: 25 mm<sup>2</sup> - 95 mm<sup>2</sup>, mounting type: direct screw connection, color: gray/black-yellow

## Your advantages

- Quick and easy connection is now also possible for large conductors with the high-current terminal block
- In addition to using the existing test pick-off, pick-off terminal blocks can be connected, each of which can also accommodate two test cables
- The compact design enables wiring in a confined space
- The Push-in connection terminal blocks are characterized by the system features of the CLIPLINE complete system and by easy and tool-free wiring of conductors with ferrules or solid conductors

## Commercial data

|                                      |               |
|--------------------------------------|---------------|
| Item number                          | 3260127       |
| Packing unit                         | 2 pc          |
| Minimum order quantity               | 2 pc          |
| Sales key                            | BE22          |
| Product key                          | BE2211        |
| GTIN                                 | 4046356779012 |
| Weight per piece (including packing) | 890.5 g       |
| Weight per piece (excluding packing) | 890.5 g       |
| Customs tariff number                | 85369010      |
| Country of origin                    | TR            |

# PTPOWER 95-3L/FE-F - High-current terminal block



3260127

<https://www.phoenixcontact.com/us/products/3260127>

## Technical data

### Product properties

|                       |                             |
|-----------------------|-----------------------------|
| Product type          | High current terminal block |
| Number of positions   | 4                           |
| Pitch                 | 25 mm                       |
| Number of connections | 8                           |
| Number of rows        | 1                           |
| Potentials            | 4                           |

### Insulation characteristics

|                      |     |
|----------------------|-----|
| Overvoltage category | III |
| Degree of pollution  | 3   |

### Electrical properties

|   |        |
|---|--------|
| Rated surge voltage                             | 8 kV   |
| Maximum power dissipation for nominal condition | 7.54 W |

### Connection data

|   |   |
|---|---|
| Number of connections per level                                   | 2   |
| Nominal cross section   | 95 mm <sup>2</sup>                                      |
| Connection method   | PowerTurn connection                                    |
| Stripping length  | 40 mm   |
| Connection in acc. with standard                                  | IEC 60947-7-1   |
| Conductor cross-section rigid                                     | 25 mm <sup>2</sup> ... 95 mm <sup>2</sup>               |
| Cross section AWG   | 2 ... 3/0 (converted acc. to IEC)                       |
| Conductor cross-section flexible                                  | 25 mm <sup>2</sup> ... 95 mm <sup>2</sup>               |
| Conductor cross-section, flexible [AWG]                           | 2 ... 3/0 (converted acc. to IEC)                       |
| Conductor cross-section flexible (ferrule without plastic sleeve) | 25 mm <sup>2</sup> ... 95 mm <sup>2</sup>               |
| Flexible conductor cross-section (ferrule with plastic sleeve)    | 25 mm <sup>2</sup> ... 95 mm <sup>2</sup>               |
| Cross-section with insertion bridge, rigid                        | 70 mm <sup>2</sup>                                      |
| Cross-section with insertion bridge, flexible                     | 70 mm <sup>2</sup>                                      |
| Nominal current   | 232 A   |
| Maximum load current  | 232 A (with 95 mm <sup>2</sup> conductor cross-section) |
| Nominal voltage   | 1000 V  |

### Connection cross sections directly pluggable

|   |   |
|---|---|
| Conductor cross-section rigid                                     | 25 mm <sup>2</sup> ... 95 mm <sup>2</sup> |
| Conductor cross-section flexible (ferrule without plastic sleeve) | 25 mm <sup>2</sup> ... 95 mm <sup>2</sup> |
| Flexible conductor cross-section (ferrule with plastic sleeve)    | 25 mm <sup>2</sup> ... 95 mm <sup>2</sup> |

### Ex data

#### Rated data (ATEX/IECEx)

|                |                        |
|----------------|------------------------|
| Identification | Ⓔ II 2 GD Ex eb IIC Gb |
|----------------|------------------------|

# PTPOWER 95-3L/FE-F - High-current terminal block



3260127

<https://www.phoenixcontact.com/us/products/3260127>

|   |   |
|---|---|
| Operating temperature range                               | -60 °C ... 110 °C                       |
| Ex-certified accessories                                  | 1206612 SZF 3-1,0X5,5                   |
| List of bridges   | Insertion bridge / EB 2-25/PT / 3260157 |
| Bridge data   | 144 A (50 mm <sup>2</sup> )             |
|   | 174 A (70 mm <sup>2</sup> )             |
| List of bridges   | Insertion bridge / EB 3-25/PT / 3260160 |
| Bridge data   | 144 A (50 mm <sup>2</sup> )             |
|   | 174 A (70 mm <sup>2</sup> )             |
| Ex temperature increase at bridging with insertion bridge | 40 K (237 A / 95 mm <sup>2</sup> )      |
| for bridging with bridge                                  | 1100 V                                  |
| Rated insulation voltage output                           | 1000 V (Permanent)                      |

## Ex level General

|                      |        |
|----------------------|--------|
| Rated voltage        | 1100 V |
| Rated current        | 215 A  |
| Maximum load current | 215 A  |
| Contact resistance   | 0.1 mΩ |

## Ex connection data General

|  |   |
|--|---|
| Ferrule length   | 40 mm                                     |
| Stripping length   | 40 mm                                     |
| Nominal cross section  | 95 mm <sup>2</sup>                        |
| Rated cross section AWG  | 4/0                                       |
| Connection capacity rigid  | 25 mm <sup>2</sup> ... 95 mm <sup>2</sup> |
| Connection capacity AWG  | 4 ... 4/0                                 |
| Conductor cross-section flexible, with ferrule without plastic sleeve min.           | 25 mm <sup>2</sup>                        |
| Conductor cross-section flexible, with ferrule without plastic sleeve max.           | 95 mm <sup>2</sup>                        |
| Single conductor/terminal point, flexible, with ferrule, without plastic sleeve, AWG | 4 ... 4/0                                 |

## Dimensions

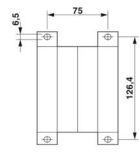
|                     |  |
|---------------------|--|
| Dimensional drawing |  |
| Width               | 100 mm   |
| Height              | 139.1 mm   |
| Depth               | 99.8 mm  |
| Drill hole spacing  | 126.4 mm   |
| Hole diameter       | 6.5 mm   |
| Pitch               | 25 mm  |

3260127

<https://www.phoenixcontact.com/us/products/3260127>

## Material specifications

|   |                      |
|---|----------------------|
| Color   | multicolored (RAL -) |
|   | gray (RAL 7042)      |
|   | black (RAL 9005)     |
|   | yellow (RAL 1018)    |
| Flammability rating according to UL 94                                  | V0                   |
| Insulating material group   | I                    |
| Insulating material   | PA                   |
| Static insulating material application in cold                          | -60 °C               |
| Temperature index of insulation material (DIN EN 60216-1 (VDE 0304-21)) | 125 °C               |
| Relative insulation material temperature index (Elec., UL 746 B)        | 130 °C               |
| Fire protection for rail vehicles (DIN EN 45545-2) R22                  | HL 1 - HL 3          |
| Fire protection for rail vehicles (DIN EN 45545-2) R23                  | HL 1 - HL 3          |
| Fire protection for rail vehicles (DIN EN 45545-2) R24                  | HL 1 - HL 3          |
| Fire protection for rail vehicles (DIN EN 45545-2) R26                  | HL 1 - HL 3          |
| Calorimetric heat release NFPA 130 (ASTM E 1354)                        | 27,5 MJ/kg           |
| Surface flammability NFPA 130 (ASTM E 162)                              | passed               |
| Specific optical density of smoke NFPA 130 (ASTM E 662)                 | passed               |
| Smoke gas toxicity NFPA 130 (SMP 800C)                                  | passed               |

## Electrical tests

### Surge voltage test

|                       |             |
|-----------------------|-------------|
| Test voltage setpoint | 9.8 kV      |
| Result                | Test passed |

### Temperature-rise test

|   |                                     |
|---|-------------------------------------|
| Requirement temperature-rise test               | Increase in temperature $\leq$ 45 K |
| Result  | Test passed                         |
| Short-time withstand current 95 mm <sup>2</sup> | 11.4 kA                             |
| Result  | Test passed                         |

### Power-frequency withstand voltage

|                       |             |
|-----------------------|-------------|
| Test voltage setpoint | 6 kV        |
| Result                | Test passed |

## Mechanical properties

### Mechanical data

|                 |    |
|-----------------|----|
| Open side panel | No |
|-----------------|----|

### Technical data

|                    |          |
|--------------------|----------|
| Drill hole spacing | 126.4 mm |
|--------------------|----------|

## Mechanical tests

# PTPOWER 95-3L/FE-F - High-current terminal block



3260127

<https://www.phoenixcontact.com/us/products/3260127>

## Mechanical strength

|        |             |
|--------|-------------|
| Result | Test passed |
|--------|-------------|

## Attachment on the carrier

|                         |             |
|-------------------------|-------------|
| DIN rail/fixing support | NS 35/15    |
| Test force setpoint     | 15 N        |
| Result                  | Test passed |

## Test for conductor damage and slackening

|                                |                             |
|--------------------------------|-----------------------------|
| Rotation speed                 | 10 rpm                      |
| Revolutions                    | 135                         |
| Conductor cross-section/weight | 25 mm <sup>2</sup> / 4.5 kg |
|                                | 95 mm <sup>2</sup> /14 kg   |
| Result                         | Test passed                 |

## Environmental and real-life conditions

### Aging

|                    |             |
|--------------------|-------------|
| Temperature cycles | 192         |
| Result             | Test passed |

### Needle-flame test

|                  |             |
|------------------|-------------|
| Time of exposure | 30 s        |
| Result           | Test passed |

### Oscillation/broadband noise

|                        |  |
|------------------------|--|
| Specification          | DIN EN 50155 (VDE 0115-200):2018-05            |
| Spectrum               | Long life test category 2, bogie-mounted       |
| Frequency              | $f_1 = 5 \text{ Hz}$ to $f_2 = 250 \text{ Hz}$ |
| ASD level              | 6.12 (m/s <sup>2</sup> ) <sup>2</sup> /Hz      |
| Acceleration           | 3.12g  |
| Test duration per axis | 5 h  |
| Test directions        | X-, Y- and Z-axis                              |
| Result                 | Test passed                                    |

### Shocks

|                                |                                     |
|--------------------------------|-------------------------------------|
| Specification                  | DIN EN 50155 (VDE 0115-200):2018-05 |
| Pulse shape                    | Half-sine                           |
| Acceleration                   | 30g                                 |
| Shock duration                 | 18 ms                               |
| Number of shocks per direction | 3                                   |
| Test directions                | X-, Y- and Z-axis (pos. and neg.)   |
| Result                         | Test passed                         |

### Ambient conditions

|                                 |  |
|---------------------------------|--|
| Ambient temperature (operation) | -60 °C ... 110 °C (Operating temperature range incl. self-heating; for max. short-term operating temperature, see RTI Elec.) |
|---------------------------------|--|

# PPOWER 95-3L/FE-F - High-current terminal block



3260127

<https://www.phoenixcontact.com/us/products/3260127>

|  |   |
|--|---|
| Ambient temperature (storage/transport)  | -25 °C ... 60 °C (for a short time, not exceeding 24 h, -60 °C to +70 °C) |
| Ambient temperature (assembly)           | -5 °C ... 70 °C   |
| Ambient temperature (actuation)          | -5 °C ... 70 °C   |
| Permissible humidity (operation)         | 20 % ... 90 %   |
| Permissible humidity (storage/transport) | 30 % ... 70 %   |

## Standards and regulations

|                                  |               |
|----------------------------------|---------------|
| Connection in acc. with standard | IEC 60947-7-1 |
|----------------------------------|---------------|

## Mounting

|               |                         |
|---------------|-------------------------|
| Mounting type | direct screw connection |
|---------------|-------------------------|

# PPOWER 95-3L/FE-F - High-current terminal block



3260127

<https://www.phoenixcontact.com/us/products/3260127>

## Drawings

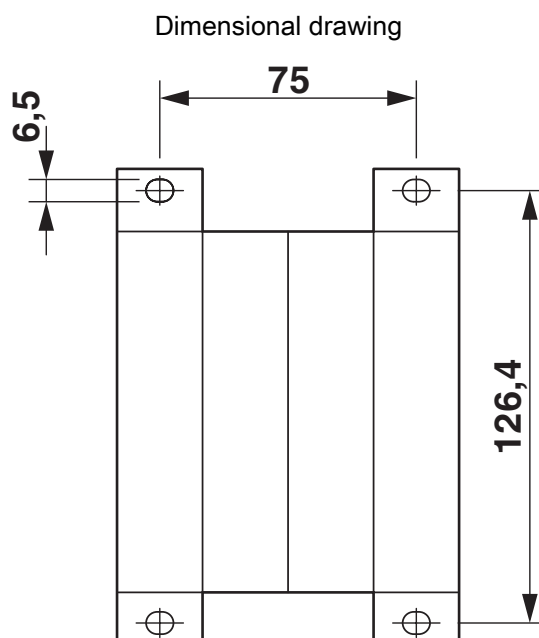

3260127

<https://www.phoenixcontact.com/us/products/3260127>

Schematic diagram

## PTPOWER



|                |  |       |
|----------------|--|-------|
| AGK 10-PTPOWER | 0,5 mm <sup>2</sup> ... 16 mm <sup>2</sup> | 18 mm |
| PTPOWER 35     | 2,5 mm <sup>2</sup> ... 35 mm <sup>2</sup> | 25 mm |
| PTPOWER 50     | 10 mm <sup>2</sup> ... 50 mm <sup>2</sup>  | 32 mm |
| PTPOWER 95     | 25 mm <sup>2</sup> ... 95 mm <sup>2</sup>  | 40 mm |
| PTPOWER 185    | 95 mm <sup>2</sup> ... 185 mm <sup>2</sup> | 40 mm |

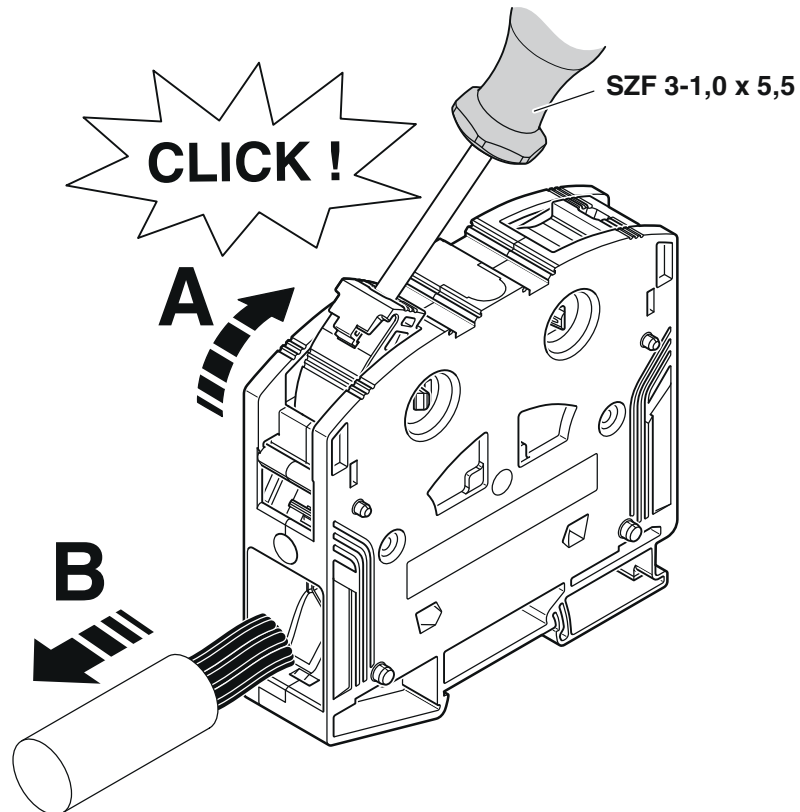

Circuit diagram

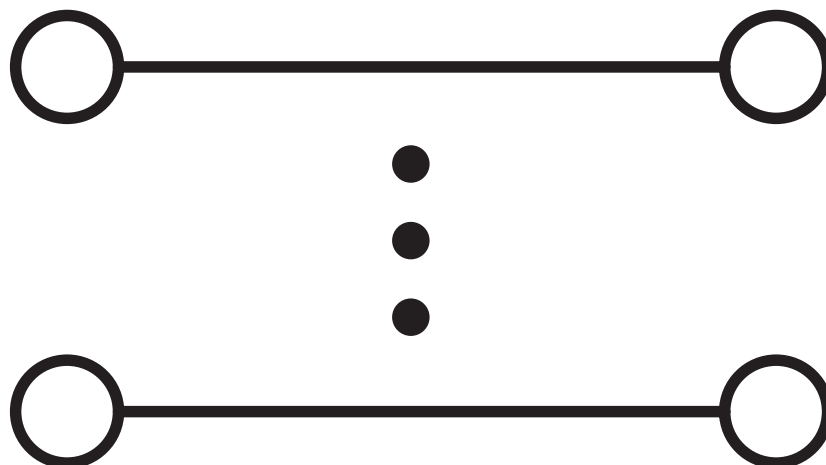

# PTPOWER 95-3L/FE-F - High-current terminal block





3260127

<https://www.phoenixcontact.com/us/products/3260127>

## Approvals

To download certificates, visit the product detail page: <https://www.phoenixcontact.com/us/products/3260127>

|  <b>CSA</b><br>Approval ID: 13631 |                       |                       |                   |                      |
|--|-----------------------|-----------------------|-------------------|----------------------|
|  | Nominal voltage $U_N$ | Nominal current $I_N$ | Cross section AWG | Cross section $mm^2$ |
| B  | 600 V                 | 230 A                 | 4 - 4/0           | -                    |
| C  | 1000 V                | 230 A                 | 4 - 4/0           | -                    |

|  <b>cUL Recognized</b><br>Approval ID: E60425 |                       |                       |                   |                      |
|--|-----------------------|-----------------------|-------------------|----------------------|
|  | Nominal voltage $U_N$ | Nominal current $I_N$ | Cross section AWG | Cross section $mm^2$ |
| C  | 1000 V                | 230 A                 | 4 - 4/0           | -                    |

|  <b>UL Recognized</b><br>Approval ID: E60425 |                       |                       |                   |                      |
|---|-----------------------|-----------------------|-------------------|----------------------|
|   | Nominal voltage $U_N$ | Nominal current $I_N$ | Cross section AWG | Cross section $mm^2$ |
| E   | 1000 V                | 230 A                 | 4 - 4/0           | -                    |

|  <b>EAC</b><br>Approval ID: RU C-DE.BL08.B.00644 |  |  |  |  |
|---|--|--|--|--|
|---|--|--|--|--|

| <b>DNV</b><br>Approval ID: TAE00000Z9 |  |  |  |  |
|---------------------------------------|--|--|--|--|
|---------------------------------------|--|--|--|--|

|  <b>EAC</b><br>Approval ID: KZ7500651131219505 |  |  |  |  |
|---|--|--|--|--|
|---|--|--|--|--|

|  <b>UKCA-EX</b><br>Approval ID: CML 22UKEX1227U |  |  |  |  |
|--|--|--|--|--|
|--|--|--|--|--|

|  <b>IECEX</b><br>Approval ID: IECEXSEV14.0013U |                       |                       |                   |                      |
|---|-----------------------|-----------------------|-------------------|----------------------|
|   | Nominal voltage $U_N$ | Nominal current $I_N$ | Cross section AWG | Cross section $mm^2$ |
| keine   |                       |                       |                   |                      |

# PTPOWER 95-3L/FE-F - High-current terminal block



3260127

<https://www.phoenixcontact.com/us/products/3260127>

|  |        |       |   |         |
|--|--------|-------|---|---------|
|  | 1100 V | 215 A | - | 25 - 95 |
|--|--------|-------|---|---------|



**ATEX**

Approval ID: SEV14ATEX0156U

|       | Nominal voltage $U_N$ | Nominal current $I_N$ | Cross section AWG | Cross section $\text{mm}^2$ |
|-------|-----------------------|-----------------------|-------------------|-----------------------------|
| keine |                       |                       |                   |                             |
|       | 1100 V                | 215 A                 | -                 | 25 - 95                     |

# PTPOWER 95-3L/FE-F - High-current terminal block



3260127

<https://www.phoenixcontact.com/us/products/3260127>

## Classifications

### ECLASS

|             |          |
|-------------|----------|
| ECLASS-13.0 | 27250101 |
| ECLASS-15.0 | 27250101 |

### ETIM

|           |          |
|-----------|----------|
| ETIM 10.0 | EC000897 |
|-----------|----------|

### UNSPSC

|             |          |
|-------------|----------|
| UNSPSC 21.0 | 39121400 |
|-------------|----------|

# PTPOWER 95-3L/FE-F - High-current terminal block



3260127

<https://www.phoenixcontact.com/us/products/3260127>

## Environmental product compliance

### EU RoHS

|   |                    |
|---|--------------------|
| Fulfills EU RoHS substance requirements | Yes, No exemptions |
|---|--------------------|

### China RoHS

|  |  |
|--|--|
| Environment friendly use period (EFUP) | EFUP-E                                   |
|  | No hazardous substances above the limits |

### EU REACH SVHC

|                                     |                            |
|-------------------------------------|----------------------------|
| REACH candidate substance (CAS No.) | No substance above 0.1 wt% |
|-------------------------------------|----------------------------|

Phoenix Contact 2026 © - all rights reserved  
<https://www.phoenixcontact.com>

Phoenix Contact USA  
586 Fulling Mill Road  
Middletown, PA 17057, United States  
(+717) 944-1300  
[info@phoenixcon.com](mailto:info@phoenixcon.com)