

PTPOWER 50-3L-F - High-current terminal block



3260057

<https://www.phoenixcontact.com/us/products/3260057>

Please be informed that the data shown in this PDF document is generated from our online catalog. Please find the complete data in the user documentation. Our general terms of use for downloads are valid.

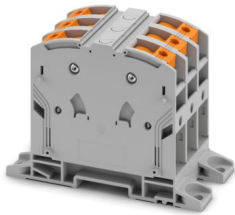

High-current terminal block, Blocked, nom. voltage: 1000 V, nominal current: 150 A, number of connections: 6, number of positions: 3, connection method: PowerTurn connection, 1 level, cross section: 10 mm² - 70 mm², mounting type: direct screw connection, color: gray

Your advantages

- Quick and easy connection is now also possible for large conductors with the high-current terminal block
- The Push-in connection terminal blocks are characterized by the system features of the CLIPLINE complete system and by easy and tool-free wiring of conductors with ferrules or solid conductors
- The compact design enables wiring in a confined space
- In addition to using the existing test pick-off, pick-off terminal blocks can be connected, each of which can also accommodate two test cables

Commercial data

Item number	3260057
Packing unit	3 pc
Minimum order quantity	3 pc
Sales key	BE22
Product key	BE2211
GTIN	4046356998734
Weight per piece (including packing)	493 g
Weight per piece (excluding packing)	493 g
Customs tariff number	85369010
Country of origin	TR

PTPOWER 50-3L-F - High-current terminal block



3260057

<https://www.phoenixcontact.com/us/products/3260057>

Technical data

Product properties

Product type	High current terminal block
Number of positions	3
Pitch	20 mm
Number of connections	6
Number of rows	1
Potentials	3

Insulation characteristics

Overvoltage category	III
Degree of pollution	3

Electrical properties

Rated surge voltage	8 kV
Maximum power dissipation for nominal condition	4.73 W

Connection data

Number of connections per level	6
Nominal cross section	50 mm ²
Rated cross section AWG	2/0

1 level

Connection method	PowerTurn connection
Stripping length	30 mm ... 32 mm
Internal cylindrical gage	A10
Connection in acc. with standard	IEC 60947-7-1
Conductor cross-section rigid	10 mm ² ... 70 mm ²
Cross section AWG	6 ... 2/0 (converted acc. to IEC)
Conductor cross-section flexible	10 mm ² ... 70 mm ²
Conductor cross-section, flexible [AWG]	6 ... 2/0 (converted acc. to IEC)
Conductor cross-section flexible (ferrule without plastic sleeve)	10 mm ² ... 50 mm ²
Flexible conductor cross-section (ferrule with plastic sleeve)	10 mm ² ... 50 mm ²
Cross-section with insertion bridge, rigid	10 mm ² ... 50 mm ²
Cross-section with insertion bridge, flexible	10 mm ² ... 50 mm ²
Cross-section with insertion bridge, flexible, with ferrule without plastic sleeve	10 mm ² (50 mm ²)
Cross-section with insertion bridge, flexible, with ferrule with plastic sleeve	10 mm ² ... 50 mm ²
Nominal current	150 A
Maximum load current	150 A (with 50 mm ² conductor cross-section)
Nominal voltage	1000 V

1 level Connection cross sections directly pluggable

PPOWER 50-3L-F - High-current terminal block



3260057

<https://www.phoenixcontact.com/us/products/3260057>

Conductor cross-section rigid	10 mm ² ... 70 mm ²
Conductor cross-section, rigid [AWG]	8 ... 2/0 (converted acc. to IEC)
Conductor cross-section flexible (ferrule without plastic sleeve)	10 mm ² ... 50 mm ²
Flexible conductor cross-section (ferrule with plastic sleeve)	10 mm ² ... 50 mm ²

Ex data

Rated data (ATEX/IECEX)

Identification	Ⓔ II 2 GD Ex eb IIC Gb
Operating temperature range	-60 °C ... 110 °C
Ex-certified accessories	1206612 SZF 3-1,0X5,5 1201662 E/AL-NS 35
List of bridges	/ EB 2-20/PT / 3260067 / EB 3-20/PT / 3260068
Bridge data	131 A (50 mm ²)
Ex temperature increase at bridging with insertion bridge	40 K (147 A / 50 mm ²)
Rated insulation voltage	1000 V
output	(Permanent)

Ex level General

Rated voltage	1100 V
Rated current	134 A
Maximum load current	134 A
Contact resistance	0.16 mΩ

Ex connection data General

Ferrule length	30 mm ... 32 mm
Stripping length	30 mm
Nominal cross section	50 mm ²
Rated cross section AWG	1/0
Connection capacity rigid	10 mm ² ... 70 mm ²
Connection capacity AWG	8 ... 2/0
Conductor cross-section flexible, with ferrule without plastic sleeve min.	16 mm ²
Conductor cross-section flexible, with ferrule without plastic sleeve max.	50 mm ²

Dimensions

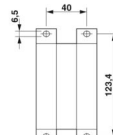
Dimensional drawing	
Width	60 mm
Height	101 mm

PTPOWER 50-3L-F - High-current terminal block



3260057

<https://www.phoenixcontact.com/us/products/3260057>

Depth	96 mm
Drill hole spacing	123.4 mm
Hole diameter	6.5 mm
Pitch	20 mm

Material specifications

Color	gray (RAL 7042)
Flammability rating according to UL 94	V0
Insulating material group	I
Insulating material	PA
Static insulating material application in cold	-60 °C
Temperature index of insulation material (DIN EN 60216-1 (VDE 0304-21))	125 °C
Relative insulation material temperature index (Elec., UL 746 B)	130 °C
Fire protection for rail vehicles (DIN EN 45545-2) R22	HL 1 - HL 3
Fire protection for rail vehicles (DIN EN 45545-2) R23	HL 1 - HL 3
Fire protection for rail vehicles (DIN EN 45545-2) R24	HL 1 - HL 3
Fire protection for rail vehicles (DIN EN 45545-2) R26	HL 1 - HL 3
Calorimetric heat release NFPA 130 (ASTM E 1354)	27,5 MJ/kg
Surface flammability NFPA 130 (ASTM E 162)	passed
Specific optical density of smoke NFPA 130 (ASTM E 662)	passed
Smoke gas toxicity NFPA 130 (SMP 800C)	passed

Mechanical properties

Mechanical data

Open side panel	No
-----------------	----

Technical data

Drill hole spacing	123.4 mm
--------------------	----------

Environmental and real-life conditions

Ambient conditions

Ambient temperature (operation)	-60 °C ... 110 °C (Operating temperature range incl. self-heating; for max. short-term operating temperature, see RTI Elec.)
Ambient temperature (storage/transport)	-25 °C ... 60 °C (for a short time, not exceeding 24 h, -60 °C to +70 °C)
Ambient temperature (assembly)	-5 °C ... 70 °C
Ambient temperature (actuation)	-5 °C ... 70 °C
Permissible humidity (operation)	20 % ... 90 %
Permissible humidity (storage/transport)	30 % ... 70 %

Standards and regulations

Connection in acc. with standard	IEC 60947-7-1
----------------------------------	---------------

Mounting

PPOWER 50-3L-F - High-current terminal block



3260057

<https://www.phoenixcontact.com/us/products/3260057>

Mounting type	direct screw connection
---------------	-------------------------

PPOWER 50-3L-F - High-current terminal block

3260057

<https://www.phoenixcontact.com/us/products/3260057>



Drawings

Dimensional drawing

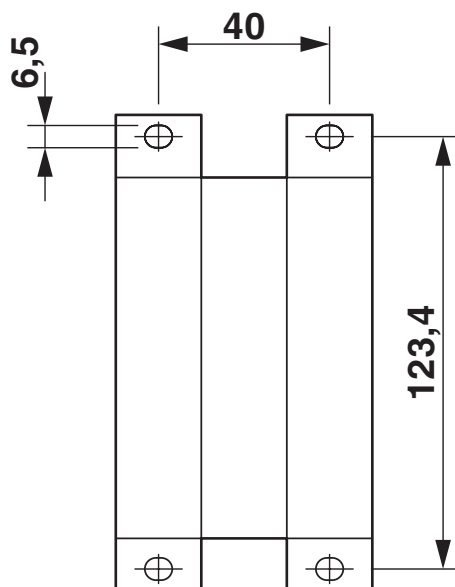

PTPOWER 50-3L-F - High-current terminal block

3260057

<https://www.phoenixcontact.com/us/products/3260057>

Schematic diagram

PTPOWER



AGK 10-PTPOWER	0,5 mm ² ... 16 mm ²	18 mm
PTPOWER 35	2,5 mm ² ... 35 mm ²	25 mm
PTPOWER 50	10 mm ² ... 50 mm ²	32 mm
PTPOWER 95	25 mm ² ... 95 mm ²	40 mm
PTPOWER 185	95 mm ² ... 185 mm ²	40 mm



PPOWER 50-3L-F - High-current terminal block



3260057

<https://www.phoenixcontact.com/us/products/3260057>

Circuit diagram

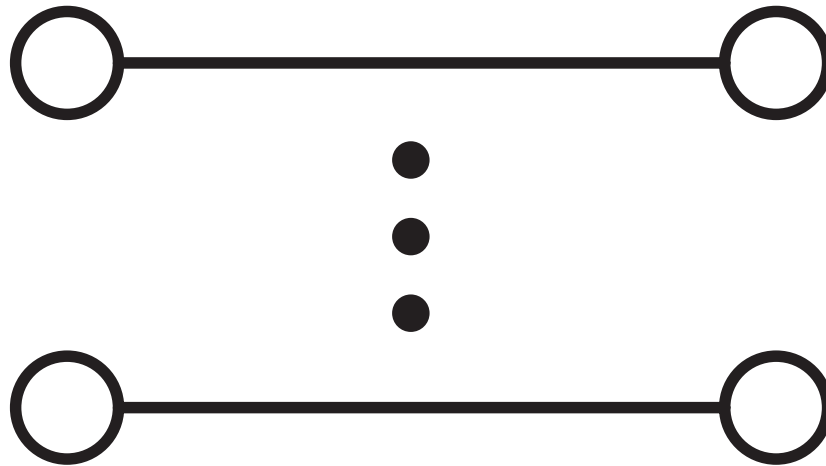

PTPOWER 50-3L-F - High-current terminal block





3260057

<https://www.phoenixcontact.com/us/products/3260057>

Approvals

To download certificates, visit the product detail page: <https://www.phoenixcontact.com/us/products/3260057>

 cUL Recognized Approval ID: E60425				
	Nominal voltage U_N	Nominal current I_N	Cross section AWG	Cross section mm^2
C	1000 V	140 A	8 - 1/0	-

 UL Recognized Approval ID: E60425				
	Nominal voltage U_N	Nominal current I_N	Cross section AWG	Cross section mm^2
E	1000 V	140 A	8 - 1/0	-

DNV Approval ID: TAE00000Z9				
---------------------------------------	--	--	--	--

 EAC Approval ID: KZ7500651131219505				
---	--	--	--	--

 CSA Approval ID: 13631				
	Nominal voltage U_N	Nominal current I_N	Cross section AWG	Cross section mm^2
B	600 V	140 A	8 - 1/0	-
C	1000 V	140 A	8 - 1/0	-

 UKCA-EX Approval ID: CML 22UKEX1227U				
--	--	--	--	--

 IECEX Approval ID: IECEXSEV14.0013U				
	Nominal voltage U_N	Nominal current I_N	Cross section AWG	Cross section mm^2
keine				
Only rigid conductors	1100 V	134 A	-	10 - 70
multi-stranded with ferrule	1100 V	134 A	-	16 - 50

PTPOWER 50-3L-F - High-current terminal block



3260057

<https://www.phoenixcontact.com/us/products/3260057>

 ATEX Approval ID: SEV14ATEX0156U				
	Nominal voltage U_N	Nominal current I_N	Cross section AWG	Cross section mm^2
keine				
Only rigid conductors	1100 V	134 A	-	10 - 70
multi-stranded with ferrule	1100 V	134 A	-	16 - 50

PTPOWER 50-3L-F - High-current terminal block



3260057

<https://www.phoenixcontact.com/us/products/3260057>

Classifications

ECLASS

ECLASS-13.0	27250101
ECLASS-15.0	27250101

ETIM

ETIM 10.0	EC000897
-----------	----------

UNSPSC

UNSPSC 21.0	39121400
-------------	----------

PTPOWER 50-3L-F - High-current terminal block



3260057

<https://www.phoenixcontact.com/us/products/3260057>

Environmental product compliance

EU RoHS

Fulfills EU RoHS substance requirements	Yes, No exemptions
---	--------------------

China RoHS

Environment friendly use period (EFUP)	EFUP-E
	No hazardous substances above the limits

EU REACH SVHC

REACH candidate substance (CAS No.)	No substance above 0.1 wt%
-------------------------------------	----------------------------

EF3.1 Climate Change

CO2e kg	5.948 kg CO2e
---------	---------------

Phoenix Contact 2026 © - all rights reserved
<https://www.phoenixcontact.com>

Phoenix Contact USA
586 Fulling Mill Road
Middletown, PA 17057, United States
(+717) 944-1300
info@phoenixcon.com