

# C-SCFFI 2,5/6,3X0,8 - Connector

3240547

<https://www.phoenixcontact.com/us/products/3240547>

Please be informed that the data shown in this PDF document is generated from our online catalog. Please find the complete data in the user documentation. Our general terms of use for downloads are valid.



Slip-on sleeve, fully isolated, blue, 1.5 ... 2.5 mm<sup>2</sup>, for plug 6.3 x 0.8 mm

## Your advantages

- Hard-soldered crimping zone for maximum conductor pull-out forces in connection with CRIMPFOX RCI... pliers
- Easy and reliable conductor entry thanks to 'EASY ENTRY'
- Halogen-free
- Electrogalvanized

## Commercial data

Item number	3240547
Packing unit	25 pc
Minimum order quantity	25 pc
Sales key	BH34
Product key	BH3451
GTIN	4046356537964
Weight per piece (including packing)	1.416 g
Weight per piece (excluding packing)	1.403 g
Customs tariff number	85366990
Country of origin	CN

# C-SCFFI 2,5/6,3X0,8 - Connector

3240547

<https://www.phoenixcontact.com/us/products/3240547>

## Technical data

### Product properties

Product type	Connector
Product property	Halogen-free
	With "Easy Entry" system
	Brazed
	PA-insulated
	Tin-plated
	Temperature range: -20°C ... +105°C
	Flammability rating V2 in accordance with UL 94

### Dimensions

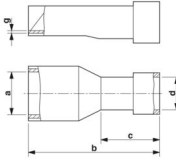
Dimensional drawing	
Width	6.3 mm
Sleeve length	22 mm
Length of the insulating material sleeve	11 mm
Maximum stripping length	8 mm
Min. material thickness	0.4 mm
Inner dimensions of the insulating collar	5 mm

### Material specifications

Color	blue (RAL 5015)
Material	Brass
Flammability rating according to UL 94	V2
Coating	electrogalvanized
Insulating material	PA
Components	halogen-free

### Mechanical properties

#### Technical data

Sleeve length	22 mm
---------------	-------

### Environmental and real-life conditions

#### Ambient conditions

Ambient temperature (operation)	-20 °C ... 105 °C
Permanent temperature	105 °C
Short-term temperature	120 °C

# C-SCFFI 2,5/6,3X0,8 - Connector

3240547

<https://www.phoenixcontact.com/us/products/3240547>



## Drawings

Dimensional drawing



# C-SCFFI 2,5/6,3X0,8 - Connector



3240547

<https://www.phoenixcontact.com/us/products/3240547>

## Classifications

### ECLASS

ECLASS-13.0	27400204
ECLASS-15.0	27400204

### ETIM

ETIM 10.0	EC001052
-----------	----------

### UNSPSC

UNSPSC 21.0	27121700
-------------	----------

# C-SCFFI 2,5/6,3X0,8 - Connector



3240547

<https://www.phoenixcontact.com/us/products/3240547>

## Environmental product compliance

### EU RoHS

Fulfills EU RoHS substance requirements	Yes, No exemptions
---	--------------------

### China RoHS

Environment friendly use period (EFUP)	EFUP-E
	No hazardous substances above the limits

### EU REACH SVHC

REACH candidate substance (CAS No.)	No substance above 0.1 wt%
-------------------------------------	----------------------------

### EF3.1 Climate Change

CO2e kg	0.032 kg CO2e
---------	---------------

Phoenix Contact 2026 © - all rights reserved  
<https://www.phoenixcontact.com>

Phoenix Contact USA  
586 Fulling Mill Road  
Middletown, PA 17057, United States  
(+717) 944-1300  
[info@phoenixcon.com](mailto:info@phoenixcon.com)