

AI-WM 0,5-8 WH - Ferrule

3240542

<https://www.phoenixcontact.com/us/products/3240542>

Please be informed that the data shown in this PDF document is generated from our online catalog. Please find the complete data in the user documentation. Our general terms of use for downloads are valid.

Ferrule with insulating collar that can be labeled. When using the magazine, the ferrules can be labeled with BLUEMARK.



Your advantages

- Electrogalvanized
- Ferrules made from electrolytic copper
- Highly resistant and optimum printing quality thanks to modern UV printing technology
- Crimping and marking in one step
- Ferrules can be labeled with BLUEMARK

Commercial data

Item number	3240542
Packing unit	780 pc
Minimum order quantity	780 pc
Sales key	BH34
Product key	BH3415
GTIN	4046356528122
Weight per piece (including packing)	0.21 g
Weight per piece (excluding packing)	0.21 g
Customs tariff number	85369010
Country of origin	DE

AI-WM 0,5-8 WH - Ferrule

3240542

<https://www.phoenixcontact.com/us/products/3240542>



Technical data

Product properties

Product type	Cable end sleeve
--------------	------------------

Dimensions

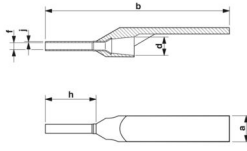
Dimensional drawing	
Width	4.6 mm
Sleeve length	8 mm
Ferrule diameter	1.4 mm
Sleeve wall thickness	0.15 mm
Inner dimensions of the insulating collar	2.9 mm

Internal dimensions

Internal diameter	1.1 mm
-------------------	--------

Material specifications

Color	white (RAL 9010)
Material	E-CU
Flammability rating according to UL 94	HB
Coating	galvanically tin-plated
Surface characteristics	Tin-plated
Components	free from silicone and halogen

Cable/line

External cable diameter	= 0.90 mm
-------------------------	-----------

Mechanical properties

Technical data

Sleeve length	8 mm
---------------	------

Environmental and real-life conditions

Ambient conditions

Ambient temperature (operation)	-40 °C ... 120 °C
Permanent temperature	105 °C (-40 °C no load / 0 °C dynamic load)
Short-term temperature	120 °C

AI-WM 0,5-8 WH - Ferrule

3240542

<https://www.phoenixcontact.com/us/products/3240542>



Drawings

Dimensional drawing

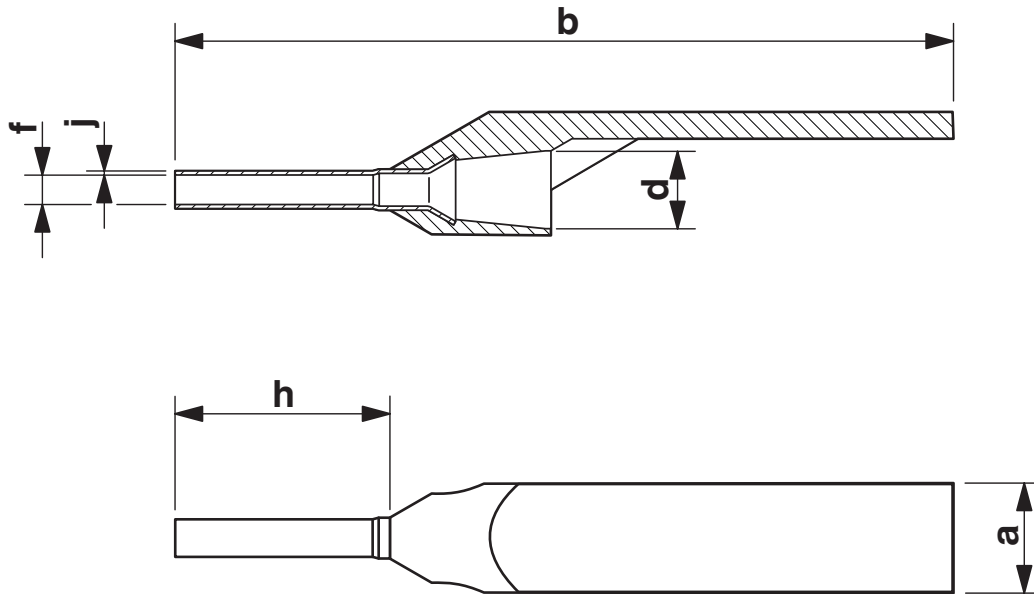

AI-WM 0,5-8 WH - Ferrule



3240542

<https://www.phoenixcontact.com/us/products/3240542>

Classifications

ECLASS

ECLASS-13.0	27400201
ECLASS-15.0	27400201

ETIM

ETIM 10.0	EC000005
-----------	----------

UNSPSC

UNSPSC 21.0	27121700
-------------	----------

AI-WM 0,5-8 WH - Ferrule



3240542

<https://www.phoenixcontact.com/us/products/3240542>

Environmental product compliance

EU RoHS

Fulfills EU RoHS substance requirements	Yes, No exemptions
---	--------------------

China RoHS

Environment friendly use period (EFUP)	EFUP-E
	No hazardous substances above the limits

EU REACH SVHC

REACH candidate substance (CAS No.)	No substance above 0.1 wt%
-------------------------------------	----------------------------

EF3.1 Climate Change

CO2e kg	0.012 kg CO2e
---------	---------------

Phoenix Contact 2026 © - all rights reserved
<https://www.phoenixcontact.com>

Phoenix Contact USA
586 Fulling Mill Road
Middletown, PA 17057, United States
(+717) 944-1300
info@phoenixcon.com