

# WCC 26 - Cable clamp

3240255

<https://www.phoenixcontact.com/us/products/3240255>

Please be informed that the data shown in this PDF document is generated from our online catalog. Please find the complete data in the user documentation. Our general terms of use for downloads are valid.

Cable clamp, for DIN rails



## Your advantages

- The cable clamps provide strain relief
- The halogen-free plastic troughs have been designed to be perfectly secure while simultaneously protecting the conductors
- Individual or bundled cables with a diameter of up to 26 mm can be installed safely and easily

## Commercial data

Item number	3240255
Packing unit	25 pc
Minimum order quantity	25 pc
Sales key	BE74
Product key	BE7421
GTIN	4046356464475
Weight per piece (including packing)	44.3 g
Weight per piece (excluding packing)	44.3 g
Customs tariff number	73269098
Country of origin	CN

# WCC 26 - Cable clamp

3240255

<https://www.phoenixcontact.com/us/products/3240255>



## Technical data

### Product properties

Product type	Cable feed-through
--------------	--------------------

### Dimensions

Dimensional drawing	
Wrench size	10 mm
Wrench size for mounting	10 mm

### Material specifications

Material	Steel
Coating	zinc plating

### Cable/line

External cable diameter	22 mm ... 26 mm
-------------------------	-----------------

### Mounting

Mounting type	DIN rail mounting
---------------	-------------------

# WCC 26 - Cable clamp

3240255

<https://www.phoenixcontact.com/us/products/3240255>



## Drawings

Dimensional drawing

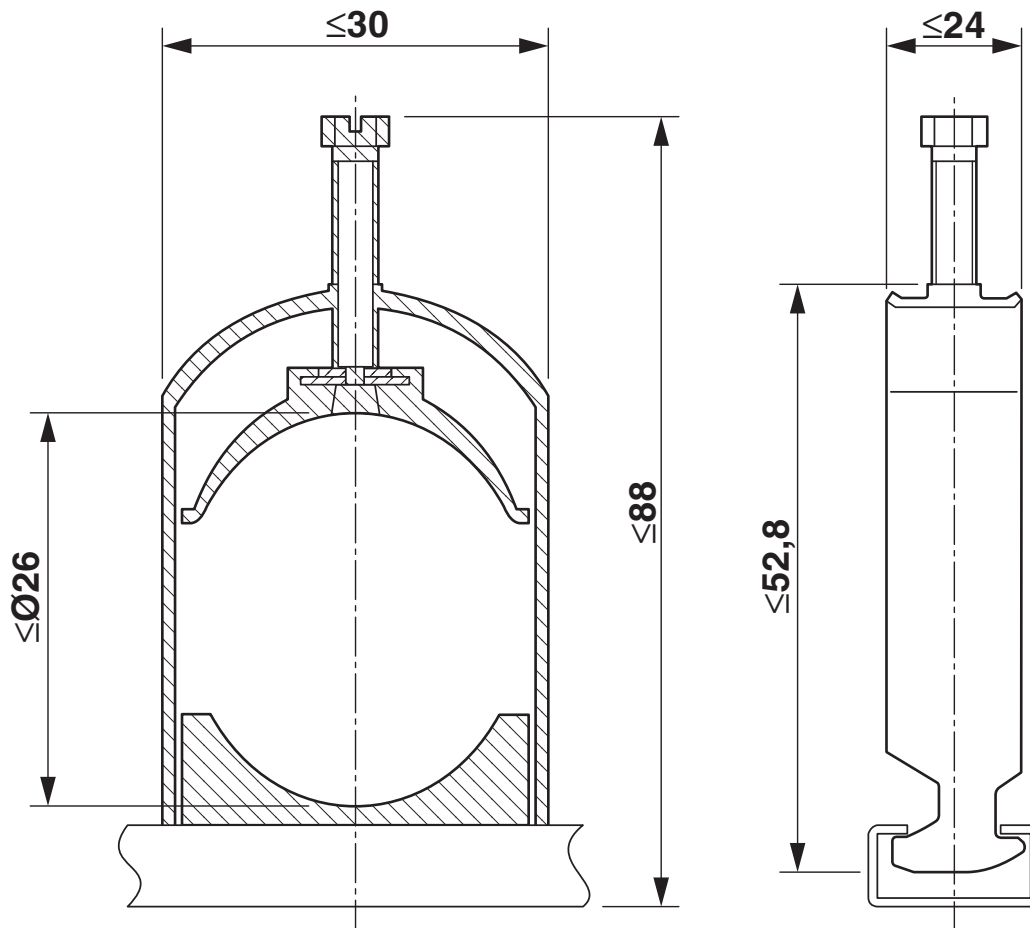

# WCC 26 - Cable clamp



3240255

<https://www.phoenixcontact.com/us/products/3240255>

## Classifications

### ECLASS

ECLASS-13.0	23159090
ECLASS-15.0	23159090

### ETIM

ETIM 10.0	EC011571
-----------	----------

### UNSPSC

UNSPSC 21.0	31162900
-------------	----------

# WCC 26 - Cable clamp



3240255

<https://www.phoenixcontact.com/us/products/3240255>

## Environmental product compliance

### EU RoHS

Fulfills EU RoHS substance requirements	Yes, No exemptions
---	--------------------

### China RoHS

Environment friendly use period (EFUP)	EFUP-E
	No hazardous substances above the limits

### EU REACH SVHC

REACH candidate substance (CAS No.)	No substance above 0.1 wt%
-------------------------------------	----------------------------

Phoenix Contact 2026 © - all rights reserved  
<https://www.phoenixcontact.com>

Phoenix Contact USA  
586 Fulling Mill Road  
Middletown, PA 17057, United States  
(+717) 944-1300  
[info@phoenixcon.com](mailto:info@phoenixcon.com)