

C-SCM 2,5/6,3X0,8 - Connector

3240162

<https://www.phoenixcontact.com/us/products/3240162>

Please be informed that the data shown in this PDF document is generated from our online catalog. Please find the complete data in the user documentation. Our general terms of use for downloads are valid.



Flat connector, non-insulated, 1.5 - 2.5 mm², 6.3 x 0.8

Your advantages

- They round out the product range in terms of connectors
- The uninsulated slip-on sleeves and flat plugs are made from electrolytically tin-plated brass

Commercial data

Item number	3240162
Packing unit	100 pc
Minimum order quantity	100 pc
Sales key	BH34
Product key	BH3452
GTIN	4046356453790
Weight per piece (including packing)	0.638 g
Weight per piece (excluding packing)	0.638 g
Customs tariff number	85366990
Country of origin	CZ

C-SCM 2,5/6,3X0,8 - Connector

3240162

<https://www.phoenixcontact.com/us/products/3240162>

Technical data

Product properties

Product type	Connector
Product property	Manufactured according to DIN 46248
	Crimp area with embossing
	Tin-plated

Electrical properties

Fuse	DIN 46248
------	-----------

Dimensions

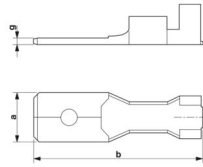
Dimensional drawing	
Width	6.3 mm
Sleeve length	20 mm
Maximum stripping length	8 mm
Min. material thickness	0.8 mm

Material specifications

Color	silver-colored
Material	Brass
Coating	tin-plated
Insulating material	nicht zutreffend

Mechanical properties

Technical data

Sleeve length	20 mm
---------------	-------

Environmental and real-life conditions

Ambient conditions

Ambient temperature (operation)	110 °C
---------------------------------	--------

C-SCM 2,5/6,3X0,8 - Connector

3240162

<https://www.phoenixcontact.com/us/products/3240162>

Drawings

Dimensional drawing

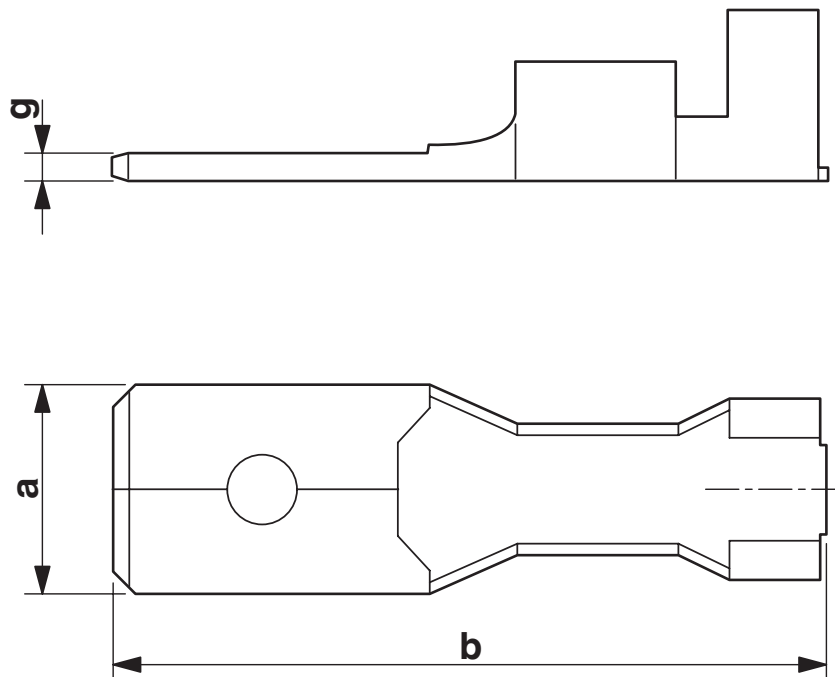

C-SCM 2,5/6,3X0,8 - Connector



3240162

<https://www.phoenixcontact.com/us/products/3240162>

Classifications

ECLASS

ECLASS-13.0	27400212
ECLASS-15.0	27400212

ETIM

ETIM 10.0	EC001059
-----------	----------

UNSPSC

UNSPSC 21.0	27121700
-------------	----------

C-SCM 2,5/6,3X0,8 - Connector



3240162

<https://www.phoenixcontact.com/us/products/3240162>

Environmental product compliance

EU RoHS

Fulfills EU RoHS substance requirements	Yes, No exemptions
---	--------------------

China RoHS

Environment friendly use period (EFUP)	EFUP-E
	No hazardous substances above the limits

EU REACH SVHC

REACH candidate substance (CAS No.)	No substance above 0.1 wt%
-------------------------------------	----------------------------

EF3.1 Climate Change

CO2e kg	0.023 kg CO2e
---------	---------------

Phoenix Contact 2026 © - all rights reserved
<https://www.phoenixcontact.com>

Phoenix Contact USA
586 Fulling Mill Road
Middletown, PA 17057, United States
(+717) 944-1300
info@phoenixcon.com