

C-FC 2,5/M3 - Fork-type cable lug

3240142

<https://www.phoenixcontact.com/us/products/3240142>

Please be informed that the data shown in this PDF document is generated from our online catalog. Please find the complete data in the user documentation. Our general terms of use for downloads are valid.



Fork-type cable lug, non-insulated, 1.1 - 2.5 mm², M3

Your advantages

- The fork-type cable lugs without plastic sleeve feature a hard-soldered neck. In conjunction with the CRIMPFOX-RC ... and CRIMPFOX-RCI ... pliers they can be used to achieve maximum conductor pull-out forces
- The insulated versions are halogen-free and feature "EASY ENTRY" technology

Commercial data

Item number	3240142
Packing unit	100 pc
Minimum order quantity	100 pc
Sales key	BH34
Product key	BH3442
GTIN	4046356453592
Weight per piece (including packing)	0.61 g
Weight per piece (excluding packing)	0.61 g
Customs tariff number	85369010
Country of origin	CN

C-FC 2,5/M3 - Fork-type cable lug

3240142

<https://www.phoenixcontact.com/us/products/3240142>

Technical data

Product properties

Product type	Connector
Product property	Design according to DIN 46234
	Brazed
	Tin-plated

Dimensions

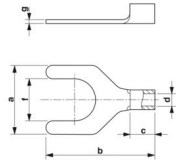
Dimensional drawing	
Width	5.7 mm
Sleeve length	16 mm
Length of the insulating material sleeve	4.8 mm
Maximum stripping length	8 mm
Distance from the center to the insulating material sleeve	6.5 mm
Min. material thickness	0.8 mm
Inner dimensions of the insulating collar	2.5 mm

Internal dimensions

Internal diameter	3.2 mm
-------------------	--------

Material specifications

Color	silver-colored
Material	Copper
Coating	tin-plated
Components	halogen-free

Mechanical properties

Technical data

Sleeve length	16 mm
---------------	-------

Environmental and real-life conditions

Ambient conditions

Ambient temperature (operation)	110 °C
---------------------------------	--------

Standards and regulations

Design according to standard	DIN 46234
------------------------------	-----------

C-FC 2,5/M3 - Fork-type cable lug

3240142

<https://www.phoenixcontact.com/us/products/3240142>



Drawings

Dimensional drawing



C-FC 2,5/M3 - Fork-type cable lug



3240142

<https://www.phoenixcontact.com/us/products/3240142>

Classifications

ECLASS

ECLASS-13.0	27400204
ECLASS-15.0	27400204

ETIM

ETIM 10.0	EC001052
-----------	----------

UNSPSC

UNSPSC 21.0	27121700
-------------	----------

C-FC 2,5/M3 - Fork-type cable lug



3240142

<https://www.phoenixcontact.com/us/products/3240142>

Environmental product compliance

EU RoHS

Fulfills EU RoHS substance requirements	Yes, No exemptions
---	--------------------

China RoHS

Environment friendly use period (EFUP)	EFUP-E
	No hazardous substances above the limits

EU REACH SVHC

REACH candidate substance (CAS No.)	No substance above 0.1 wt%
-------------------------------------	----------------------------

EF3.1 Climate Change

CO2e kg	0.016 kg CO2e
---------	---------------

Phoenix Contact 2026 © - all rights reserved
<https://www.phoenixcontact.com>

Phoenix Contact USA
586 Fulling Mill Road
Middletown, PA 17057, United States
(+717) 944-1300
info@phoenixcon.com