

C-SCFI 1,5/4,8X0,8 - Connector

3240051

<https://www.phoenixcontact.com/us/products/3240051>

Please be informed that the data shown in this PDF document is generated from our online catalog. Please find the complete data in the user documentation. Our general terms of use for downloads are valid.



Slip-on sleeve, red, 0.5 ... 1.5 mm², 4.8 x 0.8

Your advantages

- "Easy Entry" for easy and reliable conductor entry
- Halogen-free
- Hard-soldered crimping zone for maximum pull-out forces
- Electrogalvanized

Commercial data

Item number	3240051
Packing unit	100 pc
Minimum order quantity	100 pc
Sales key	BH34
Product key	BH3451
GTIN	4046356452694
Weight per piece (including packing)	0.852 g
Weight per piece (excluding packing)	0.852 g
Customs tariff number	85366990
Country of origin	CN

C-SCFI 1,5/4,8X0,8 - Connector

3240051

<https://www.phoenixcontact.com/us/products/3240051>

Technical data

Product properties

Product type	Connector
Product property	Halogen-free
	With "Easy Entry" system
	Brazed
	PA-insulated

Dimensions

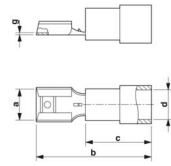
Dimensional drawing	
Width	4.8 mm
Sleeve length	19.5 mm
Length of the insulating material sleeve	10.5 mm
Maximum stripping length	7 mm
Min. material thickness	0.4 mm
Inner dimensions of the insulating collar	4.1 mm

Material specifications

Color	red (RAL 3001)
Material	Brass
Flammability rating according to UL 94	V2
Coating	tin-plated
Insulating material	PA
Components	halogen-free

Mechanical properties

Technical data

Sleeve length	19.5 mm
---------------	---------

Environmental and real-life conditions

Ambient conditions

Ambient temperature (operation)	-20 °C ... 105 °C
---------------------------------	-------------------

C-SCFI 1,5/4,8X0,8 - Connector

3240051

<https://www.phoenixcontact.com/us/products/3240051>



Drawings

Dimensional drawing

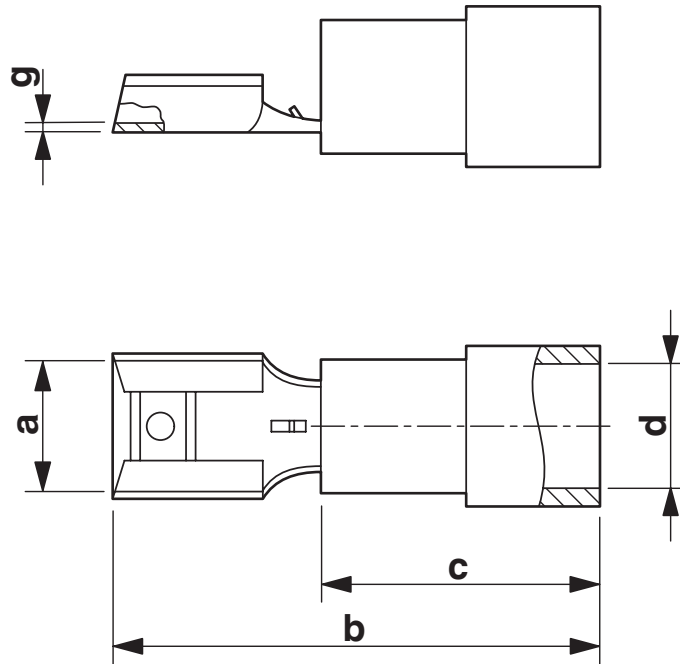

C-SCFI 1,5/4,8X0,8 - Connector



3240051

<https://www.phoenixcontact.com/us/products/3240051>

Classifications

ECLASS

ECLASS-13.0	27400204
ECLASS-15.0	27400204

ETIM

ETIM 10.0	EC001052
-----------	----------

UNSPSC

UNSPSC 21.0	27121700
-------------	----------

C-SCFI 1,5/4,8X0,8 - Connector



3240051

<https://www.phoenixcontact.com/us/products/3240051>

Environmental product compliance

EU RoHS

Fulfills EU RoHS substance requirements	Yes, No exemptions
---	--------------------

China RoHS

Environment friendly use period (EFUP)	EFUP-E
	No hazardous substances above the limits

EU REACH SVHC

REACH candidate substance (CAS No.)	No substance above 0.1 wt%
-------------------------------------	----------------------------

EF3.1 Climate Change

CO2e kg	2.339 kg CO2e
---------	---------------

Phoenix Contact 2026 © - all rights reserved
<https://www.phoenixcontact.com>

Phoenix Contact USA
586 Fulling Mill Road
Middletown, PA 17057, United States
(+717) 944-1300
info@phoenixcon.com