

C-RCI 2,5/M5 - Ring cable lug

3240024

<https://www.phoenixcontact.com/us/products/3240024>

Please be informed that the data shown in this PDF document is generated from our online catalog. Please find the complete data in the user documentation. Our general terms of use for downloads are valid.



Ring cable lug, blue, 1.5 ... 2.5 mm², M5

Your advantages

- The sleeves are conically tapered to facilitate easy and correct insertion of the conductor
- The insulated ring cable lugs with plastic sleeve are hard-soldered and feature the 'EASY ENTRY' system

Commercial data

Item number	3240024
Packing unit	100 pc
Minimum order quantity	100 pc
Sales key	BH34
Product key	BH3421
GTIN	4046356452014
Weight per piece (including packing)	0.964 g
Weight per piece (excluding packing)	0.945 g
Customs tariff number	85369010
Country of origin	CN

C-RCI 2,5/M5 - Ring cable lug

3240024

<https://www.phoenixcontact.com/us/products/3240024>

Technical data

Product properties

Product type	Connector
Product property	Halogen-free
	With "Easy Entry" system
	Brazed
	PA-insulated

Dimensions

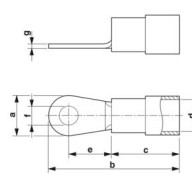
Dimensional drawing	
Width	9.5 mm
Sleeve length	23 mm
Length of the insulating material sleeve	11 mm
Maximum stripping length	8 mm
Distance from the center to the insulating material sleeve	7.3 mm
Min. material thickness	0.8 mm
Inner dimensions of the insulating collar	4.5 mm

Internal dimensions

Internal diameter	5.3 mm
-------------------	--------

Material specifications

Color	blue (RAL 5015)
Material	Copper
Flammability rating according to UL 94	V2
Coating	tin-plated
Insulating material	PA
Components	halogen-free

Mechanical properties

Technical data

Sleeve length	23 mm
---------------	-------

Environmental and real-life conditions

Ambient conditions

Optimum ambient temperature (storage/transport)	20.00 °C 50.00 % Humidity (RH), store inside sealed original packaging. Avoid direct sunlight and heat.
Ambient temperature (operation)	-20 °C ... 105 °C

C-RCI 2,5/M5 - Ring cable lug



3240024

<https://www.phoenixcontact.com/us/products/3240024>

Ambient temperature (assembly)	-20 °C ... 100 °C
Short-term temperature	100 °C

C-RCI 2,5/M5 - Ring cable lug

3240024

<https://www.phoenixcontact.com/us/products/3240024>



Drawings

Dimensional drawing



C-RCI 2,5/M5 - Ring cable lug



3240024

<https://www.phoenixcontact.com/us/products/3240024>

Classifications

ECLASS

ECLASS-13.0	27400204
ECLASS-15.0	27400204

ETIM

ETIM 10.0	EC001052
-----------	----------

UNSPSC

UNSPSC 21.0	27121700
-------------	----------

C-RCI 2,5/M5 - Ring cable lug



3240024

<https://www.phoenixcontact.com/us/products/3240024>

Environmental product compliance

EU RoHS

Fulfills EU RoHS substance requirements	Yes, No exemptions
-----------------------------------------	--------------------

China RoHS

Environment friendly use period (EFUP)	EFUP-E
	No hazardous substances above the limits

EU REACH SVHC

REACH candidate substance (CAS No.)	No substance above 0.1 wt%
-------------------------------------	----------------------------

EF3.1 Climate Change

CO2e kg	0.021 kg CO2e
---------	---------------

Phoenix Contact 2026 © - all rights reserved
<https://www.phoenixcontact.com>

Phoenix Contact USA
586 Fulling Mill Road
Middletown, PA 17057, United States
(+717) 944-1300
info@phoenixcon.com