

AI 1,5 -10 BK-1000 - Ferrule

3203134

<https://www.phoenixcontact.com/us/products/3203134>

Please be informed that the data shown in this PDF document is generated from our online catalog. Please find the complete data in the user documentation. Our general terms of use for downloads are valid.

Ferrule, Length contact range: 10 mm, sleeve length: 16 mm, color: black



Your advantages

- The ferrules with plastic sleeve are made from soft tin-plated electrolytic copper
- The insulation reliability of close connections is increased and the splicing of wires is prevented

Commercial data

Item number	3203134
Packing unit	1,000 pc
Minimum order quantity	1,000 pc
Sales key	BH34
Product key	BH3411
GTIN	4046356079594
Weight per piece (including packing)	0.128 g
Weight per piece (excluding packing)	0.126 g
Customs tariff number	85369010
Country of origin	DE

AI 1,5 -10 BK-1000 - Ferrule

3203134

<https://www.phoenixcontact.com/us/products/3203134>

Technical data

Product properties

Product type	Cable end sleeve
Conductor category	stranded conductors, class 2, 5, 6 / B, C, K, M
Product property	UL certified
	Made from soft tin-plated electrolytic copper
	Correspond to the requirements of DIN 46228-4 and UL 486F in terms of size
	Plastic collar made of polypropylene
	Halogen-free
	Long/short-term temperature: +105°C/+120°C

Connection data

Conductor connection

Conductor cross-section flexible max.	1.5 mm ²
Conductor cross-section AWG max.	16
Stripping length	13 mm

Dimensions

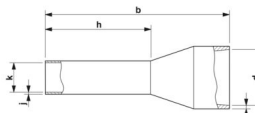
Dimensional drawing	
Sleeve length	16 mm
Length contact range	10 mm
Maximum stripping length	13 mm
Ferrule diameter	1.7 mm
Sleeve wall thickness	0.15 mm
Insulating collar thickness	0.3 mm
Inner dimensions of the insulating collar	3.4 mm

Material specifications

Color	black (RAL 9005)
Material	CU-DHP
Flammability rating according to UL 94	HB
Coating	galvanically tin-plated
Surface characteristics	Tin-plated
Components	free from silicone and halogen

Mechanical properties

Technical data

AI 1,5 -10 BK-1000 - Ferrule



3203134

<https://www.phoenixcontact.com/us/products/3203134>

Sleeve length	16 mm
---------------	-------

Environmental and real-life conditions

Ambient conditions

Permanent temperature	105 °C (-40 °C no load / 0 °C dynamic load)
Short-term temperature	120 °C

Standards and regulations

Design according to standard	DIN 46228-4, UL 486F-E, NFC 63-023
------------------------------	------------------------------------

Drawings

Dimensional drawing



Sleeve length (b), length contact range (h), insulating collar inner dimension (d), sleeve diameter (k), insulating collar thickness (i), sleeve wall thickness (j)

AI 1,5 -10 BK-1000 - Ferrule



3203134

<https://www.phoenixcontact.com/us/products/3203134>

Approvals

To download certificates, visit the product detail page: <https://www.phoenixcontact.com/us/products/3203134>



cULus Listed

Approval ID: E488001

AI 1,5 -10 BK-1000 - Ferrule



3203134

<https://www.phoenixcontact.com/us/products/3203134>

Classifications

ECLASS

ECLASS-13.0	27400201
ECLASS-15.0	27400201

ETIM

ETIM 10.0	EC000005
-----------	----------

UNSPSC

UNSPSC 21.0	27121700
-------------	----------

AI 1,5 -10 BK-1000 - Ferrule



3203134

<https://www.phoenixcontact.com/us/products/3203134>

Environmental product compliance

EU RoHS

Fulfills EU RoHS substance requirements	Yes, No exemptions
---	--------------------

China RoHS

Environment friendly use period (EFUP)	EFUP-E
	No hazardous substances above the limits

EU REACH SVHC

REACH candidate substance (CAS No.)	No substance above 0.1 wt%
-------------------------------------	----------------------------

EF3.1 Climate Change

CO2e kg	0.002 kg CO2e
---------	---------------

Phoenix Contact 2026 © - all rights reserved
<https://www.phoenixcontact.com>

Phoenix Contact USA
586 Fulling Mill Road
Middletown, PA 17057, United States
(+717) 944-1300
info@phoenixcon.com