

# AI 16 -12 GN - Ferrule

3201152

<https://www.phoenixcontact.com/us/products/3201152>



Please be informed that the data shown in this PDF document is generated from our online catalog. Please find the complete data in the user documentation. Our general terms of use for downloads are valid.

Ferrule, Length contact range: 12 mm, sleeve length: 24 mm, color: green



## Your advantages

- The ferrules with plastic sleeve are made from soft tin-plated electrolytic copper
- In terms of dimensions, they correspond to DIN 46228-4: 1990-09

## Commercial data

Item number	3201152
Packing unit	100 pc
Minimum order quantity	100 pc
Sales key	BH34
Product key	BH3411
GTIN	4017918094706
Weight per piece (including packing)	0.776 g
Weight per piece (excluding packing)	0.6 g
Customs tariff number	85369010
Country of origin	DE

# AI 16 -12 GN - Ferrule

3201152

<https://www.phoenixcontact.com/us/products/3201152>

## Technical data

### Product properties

Product type	Cable end sleeve
Conductor category	stranded conductors, class 2, 5, 6 / B, C, K, M
Product property	UL certified
	Made from soft tin-plated electrolytic copper
	Correspond to the requirements of DIN 46228-4 and UL 486F in terms of size
	Plastic collar made of polypropylene
	Halogen-free
	Long/short-term temperature: +105°C/+120°C

### Connection data

#### Conductor connection

Conductor cross-section flexible max.	16 mm <sup>2</sup>
Conductor cross-section AWG max.	6
Stripping length	16 mm

### Dimensions

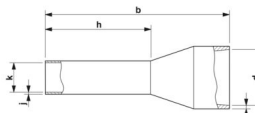
Dimensional drawing	
Sleeve length	24 mm
Length contact range	12 mm
Maximum stripping length	16 mm
Ferrule diameter	5.8 mm
Sleeve wall thickness	0.2 mm
Insulating collar thickness	0.4 mm
Inner dimensions of the insulating collar	8.8 mm

### Material specifications

Color	green (RAL 6021)
Material	CU-DHP
Flammability rating according to UL 94	HB
Coating	galvanically tin-plated
Surface characteristics	Tin-plated
Components	free from silicone and halogen

### Mechanical properties

#### Technical data

# AI 16 -12 GN - Ferrule



3201152

<https://www.phoenixcontact.com/us/products/3201152>

Sleeve length	24 mm
---------------	-------

## Environmental and real-life conditions

### Ambient conditions

Permanent temperature	105 °C (-40 °C no load / 0 °C dynamic load)
Short-term temperature	120 °C

## Standards and regulations

Design according to standard	UL 486F-E, Sonderfarbe
------------------------------	------------------------

Drawings

Dimensional drawing



Sleeve length (b), length contact range (h), insulating collar inner dimension (d), sleeve diameter (k), insulating collar thickness (i), sleeve wall thickness (j)

# AI 16 -12 GN - Ferrule

3201152

<https://www.phoenixcontact.com/us/products/3201152>



## Approvals

🔗 To download certificates, visit the product detail page: <https://www.phoenixcontact.com/us/products/3201152>



**cULus Listed**

Approval ID: E488001

# AI 16 -12 GN - Ferrule



3201152

<https://www.phoenixcontact.com/us/products/3201152>

## Classifications

### ECLASS

ECLASS-13.0	27400201
ECLASS-15.0	27400201

### ETIM

ETIM 10.0	EC000005
-----------	----------

### UNSPSC

UNSPSC 21.0	27121700
-------------	----------

# AI 16 -12 GN - Ferrule



3201152

<https://www.phoenixcontact.com/us/products/3201152>

## Environmental product compliance

### EU RoHS

Fulfills EU RoHS substance requirements	Yes, No exemptions
---	--------------------

### China RoHS

Environment friendly use period (EFUP)	EFUP-E
	No hazardous substances above the limits

### EU REACH SVHC

REACH candidate substance (CAS No.)	No substance above 0.1 wt%
-------------------------------------	----------------------------

### EF3.1 Climate Change

CO2e kg	0.006 kg CO2e
---------	---------------

Phoenix Contact 2026 © - all rights reserved  
<https://www.phoenixcontact.com>

Phoenix Contact USA  
586 Fulling Mill Road  
Middletown, PA 17057, United States  
(+717) 944-1300  
[info@phoenixcon.com](mailto:info@phoenixcon.com)