

# KDT-ST 14 - Filler plug

3062032

<https://www.phoenixcontact.com/us/products/3062032>

Please be informed that the data shown in this PDF document is generated from our online catalog. Please find the complete data in the user documentation. Our general terms of use for downloads are valid.

Filler plug, material: PA, length: 20 mm, diameter: 14 mm



## Commercial data

Item number	3062032
Packing unit	25 pc
Minimum order quantity	25 pc
Sales key	BF67
Product key	AF7CZX
GTIN	4046356301497
Weight per piece (including packing)	3.16 g
Weight per piece (excluding packing)	2.8 g
Customs tariff number	39174000
Country of origin	DE

# KDT-ST 14 - Filler plug

3062032

<https://www.phoenixcontact.com/us/products/3062032>



## Technical data

### Product properties

Product type	Sealing plugs
--------------	---------------

### Dimensions

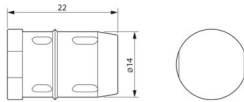
Dimensional drawing	
Length	20 mm
Diameter	14 mm

### Material specifications

Color	black (RAL 9005)
Material	PA

### Environmental and real-life conditions

#### Ambient conditions

Degree of protection	IP54 (Observe the assembly instructions)
Ambient temperature (operation)	-20 °C ... 80 °C

### Mounting

Assembly note	IP54: for vertical sealing frame mounting/for horizontal sealing frame mounting (downward cable outlet direction).
---------------	--

# KDT-ST 14 - Filler plug

3062032

<https://www.phoenixcontact.com/us/products/3062032>



## Drawings

Dimensional drawing

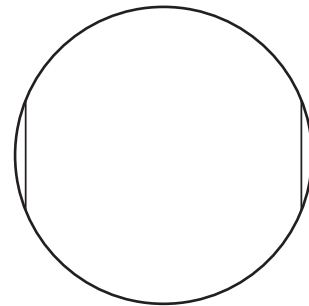
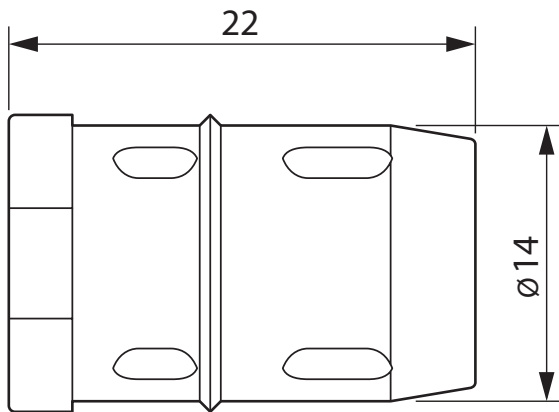

Dimensional drawing

# KDT-ST 14 - Filler plug

3062032

<https://www.phoenixcontact.com/us/products/3062032>



## Classifications

### ECLASS

ECLASS-13.0	23111190
ECLASS-15.0	27144492

### ETIM

ETIM 10.0	EC002610
-----------	----------

### UNSPSC

UNSPSC 21.0	39121300
-------------	----------

# KDT-ST 14 - Filler plug



3062032

<https://www.phoenixcontact.com/us/products/3062032>

## Environmental product compliance

### EU RoHS

Fulfills EU RoHS substance requirements	Yes, No exemptions
---	--------------------

### China RoHS

Environment friendly use period (EFUP)	EFUP-E
	No hazardous substances above the limits

### EU REACH SVHC

REACH candidate substance (CAS No.)	No substance above 0.1 wt%
-------------------------------------	----------------------------

### EF3.1 Climate Change

CO2e kg	0.027 kg CO2e
---------	---------------

Phoenix Contact 2026 © - all rights reserved  
<https://www.phoenixcontact.com>

Phoenix Contact USA  
586 Fulling Mill Road  
Middletown, PA 17057, United States  
(+717) 944-1300  
[info@phoenixcon.com](mailto:info@phoenixcon.com)