

STTB 2,5/2P - Double-level terminal block



3040054

<https://www.phoenixcontact.com/us/products/3040054>

Please be informed that the data shown in this PDF document is generated from our online catalog. Please find the complete data in the user documentation. Our general terms of use for downloads are valid.

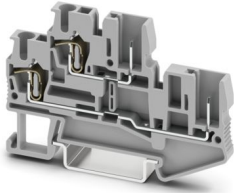

Double-level terminal block, Current and voltage are determined by the plug used., nom. voltage: 500 V, nominal current: 22 A, connection method: Spring-cage/plug-in connection, 1st and 2nd level connection left, Rated cross section: 2.5 mm², cross section: 0.08 mm² - 4 mm², 1st and 2nd level connection right, mounting type: NS 35/15, NS 35/7,5, color: gray

Your advantages

- Tested for railway applications
- Potential routing on two levels

Commercial data

Item number	3040054
Packing unit	50 pc
Minimum order quantity	50 pc
Sales key	BE02
Product key	BE2141
GTIN	4017918832650
Weight per piece (including packing)	9.95 g
Weight per piece (excluding packing)	9.89 g
Customs tariff number	85369010
Country of origin	PL

STTB 2,5/2P - Double-level terminal block



3040054

<https://www.phoenixcontact.com/us/products/3040054>

Technical data

Product properties

Product type	Plug-in terminal block
Product family	STTB
Area of application	Railway industry
	Machine building
	Plant engineering
Number of connections	4
Number of rows	2
Potentials	2

Insulation characteristics

Overvoltage category	III
Degree of pollution	3

Electrical properties

Rated surge voltage	6 kV
Maximum power dissipation for nominal condition	0.77 W

Connection data

Number of connections per level	2
Nominal cross section	2.5 mm ²

1st and 2nd level connection left

Connection method	Spring-cage/plug-in connection
Stripping length	8 mm ... 10 mm
Internal cylindrical gage	A3
Connection in acc. with standard	IEC 61984
Conductor cross-section rigid	0.08 mm ² ... 4 mm ²
Cross section AWG	28 ... 12 (converted acc. to IEC)
Conductor cross-section flexible	0.08 mm ² ... 2.5 mm ²
Conductor cross-section, flexible [AWG]	28 ... 14 (converted acc. to IEC)
Conductor cross-section flexible (ferrule without plastic sleeve)	0.14 mm ² ... 2.5 mm ²
Flexible conductor cross-section (ferrule with plastic sleeve)	0.14 mm ² ... 2.5 mm ²
2 conductors with the same cross section, flexible, with TWIN ferrule with plastic sleeve	0.5 mm ²
Nominal cross section	2.5 mm ²
Nominal current	22 A
Maximum load current	22 A (with 4 mm ² conductor cross-section)
Nominal voltage	500 V

Dimensions

STTB 2,5/2P - Double-level terminal block



3040054

<https://www.phoenixcontact.com/us/products/3040054>

Dimensional drawing	
Width	5.2 mm
End cover width	2.2 mm
Height	71.5 mm
Depth on NS 35/7,5	47.5 mm
Depth on NS 35/15	55 mm

Material specifications

Color	gray (RAL 7042)
Flammability rating according to UL 94	V0
Insulating material group	I
Insulating material	PA
Static insulating material application in cold	-60 °C
Temperature index of insulation material (DIN EN 60216-1 (VDE 0304-21))	130 °C
Relative insulation material temperature index (Elec., UL 746 B)	130 °C
Fire protection for rail vehicles (DIN EN 45545-2) R22	HL 1 - HL 3
Fire protection for rail vehicles (DIN EN 45545-2) R23	HL 1 - HL 3
Fire protection for rail vehicles (DIN EN 45545-2) R24	HL 1 - HL 3
Fire protection for rail vehicles (DIN EN 45545-2) R26	HL 1 - HL 3
Calorimetric heat release NFPA 130 (ASTM E 1354)	28 MJ/kg
Surface flammability NFPA 130 (ASTM E 162)	passed
Specific optical density of smoke NFPA 130 (ASTM E 662)	passed
Smoke gas toxicity NFPA 130 (SMP 800C)	passed

Electrical tests

Surge voltage test

Test voltage setpoint	7.3 kV
Result	Test passed
Short-time withstand current 2.5 mm ²	0.3 kA
Result	Test passed

Power-frequency withstand voltage

Test voltage setpoint	1.89 kV
Result	Test passed

Mechanical properties

Mechanical data

STTB 2,5/2P - Double-level terminal block



3040054

<https://www.phoenixcontact.com/us/products/3040054>

Open side panel	Yes
-----------------	-----

Mechanical tests

Attachment on the carrier

DIN rail/fixing support	NS 35
Test force setpoint	1 N
Result	Test passed

Environmental and real-life conditions

Needle-flame test

Time of exposure	30 s
Result	Test passed

Oscillation/broadband noise

Specification	DIN EN 50155 (VDE 0115-200):2008-03
Spectrum	Long life test category 1, class B, body mounted
Frequency	$f_1 = 5 \text{ Hz}$ to $f_2 = 150 \text{ Hz}$
ASD level	$0.964 \text{ (m/s}^2\text{)}^2\text{/Hz}$
Acceleration	0.58g
Test duration per axis	5 h
Test directions	X-, Y- and Z-axis
Result	Test passed

Shocks

Specification	DIN EN 50155 (VDE 0115-200):2008-03
Pulse shape	Half-sine
Acceleration	5g
Shock duration	30 ms
Number of shocks per direction	3
Test directions	X-, Y- and Z-axis (pos. and neg.)
Result	Test passed

Ambient conditions

Ambient temperature (operation)	-60 °C ... 100 °C (max. operating temperature range including self-heating, see derating curve)
Ambient temperature (storage/transport)	-25 °C ... 60 °C (for a short time, not exceeding 24 h, -60 °C to +70 °C)
Ambient temperature (assembly)	-5 °C ... 70 °C
Ambient temperature (actuation)	-5 °C ... 70 °C
Permissible humidity (operation)	20 % ... 90 %
Permissible humidity (storage/transport)	30 % ... 70 %

Standards and regulations

Connection in acc. with standard	IEC 61984
----------------------------------	-----------

STTB 2,5/2P - Double-level terminal block



3040054

<https://www.phoenixcontact.com/us/products/3040054>

Mounting

Mounting type	NS 35/15
	NS 35/7,5

STTB 2,5/2P - Double-level terminal block

3040054

<https://www.phoenixcontact.com/us/products/3040054>

Drawings

Dimensional drawing



Diagram

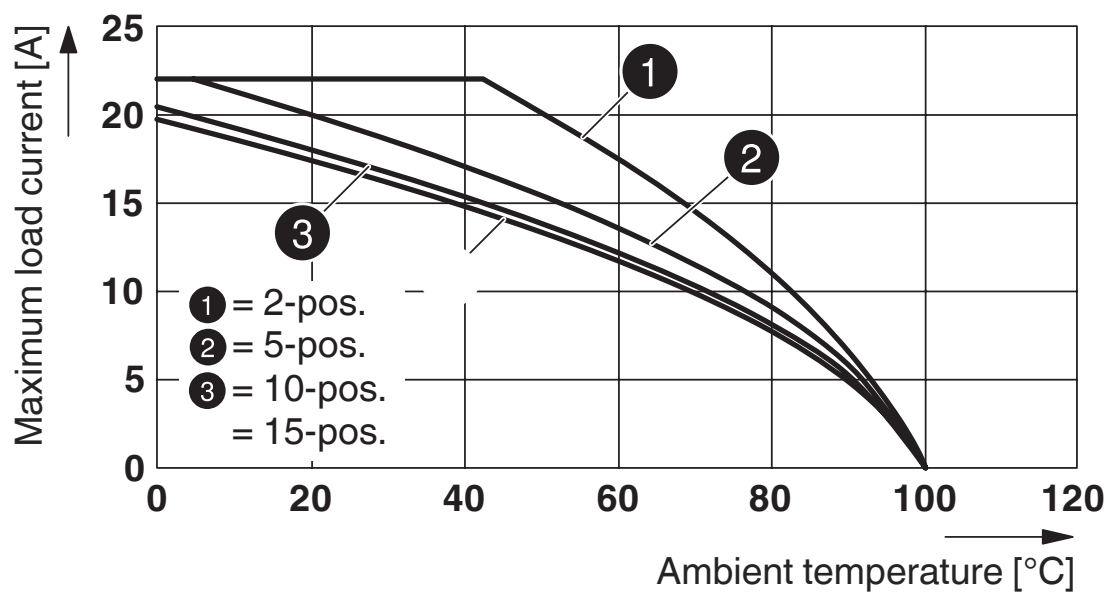

Applies to all male connector variants SP...

STTB 2,5/2P - Double-level terminal block



3040054

<https://www.phoenixcontact.com/us/products/3040054>

Circuit diagram

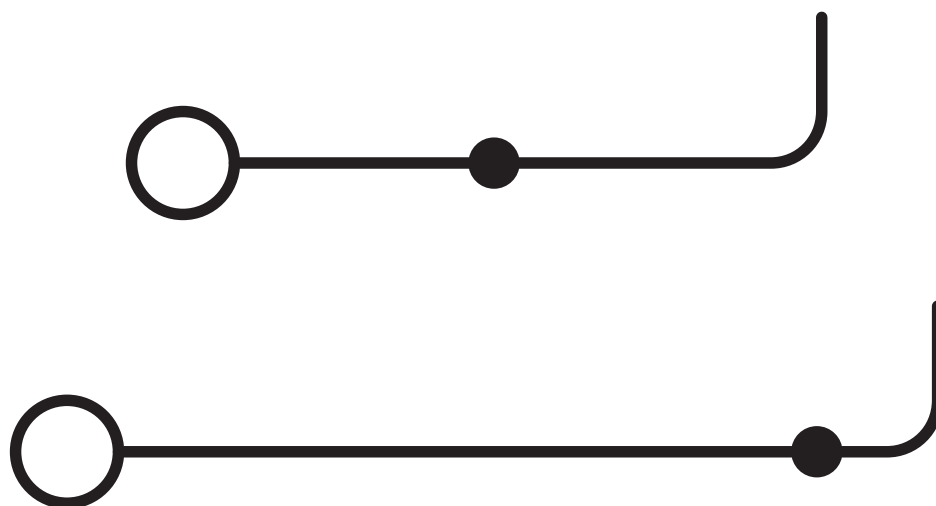

STTB 2,5/2P - Double-level terminal block



3040054

<https://www.phoenixcontact.com/us/products/3040054>

Approvals

To download certificates, visit the product detail page: <https://www.phoenixcontact.com/us/products/3040054>

 CSA Approval ID: 13631				
	Nominal voltage U_N	Nominal current I_N	Cross section AWG	Cross section mm^2
B	300 V	20 A	28 - 12	-
C	300 V	20 A	28 - 12	-
D	600 V	5 A	28 - 12	-

 IECEE CB Scheme Approval ID: DE1-62736/B1/B2				
--	--	--	--	--

 EAC Approval ID: RU C-DE.BL08.B.00644				
---	--	--	--	--

 VDE Zeichengenehmigung Approval ID: 40019518				
	Nominal voltage U_N	Nominal current I_N	Cross section AWG	Cross section mm^2
keine				
Only flexible conductors	500 V	-	-	0.2 - 2.5
Only rigid conductors	500 V	-	-	0.2 - 4

 cULus Recognized Approval ID: E60425				
	Nominal voltage U_N	Nominal current I_N	Cross section AWG	Cross section mm^2
B	300 V	20 A	28 - 12	-
C	300 V	20 A	28 - 12	-
D	600 V	5 A	28 - 12	-

DNV Approval ID: TAE00001CS				
---------------------------------------	--	--	--	--

STTB 2,5/2P - Double-level terminal block



3040054

<https://www.phoenixcontact.com/us/products/3040054>



EAC

Approval ID: KZ7500651131219505

STTB 2,5/2P - Double-level terminal block



3040054

<https://www.phoenixcontact.com/us/products/3040054>

Classifications

ECLASS

ECLASS-13.0	27250117
ECLASS-15.0	27250117

ETIM

ETIM 10.0	EC000897
-----------	----------

UNSPSC

UNSPSC 21.0	39121400
-------------	----------

STTB 2,5/2P - Double-level terminal block



3040054

<https://www.phoenixcontact.com/us/products/3040054>

Environmental product compliance

EU RoHS

Fulfills EU RoHS substance requirements	Yes, No exemptions
---	--------------------

China RoHS

Environment friendly use period (EFUP)	EFUP-E
	No hazardous substances above the limits

EU REACH SVHC

REACH candidate substance (CAS No.)	No substance above 0.1 wt%
-------------------------------------	----------------------------

EF3.1 Climate Change

CO2e kg	0.046 kg CO2e
---------	---------------

Phoenix Contact 2026 © - all rights reserved
<https://www.phoenixcontact.com>

Phoenix Contact USA
586 Fulling Mill Road
Middletown, PA 17057, United States
(+717) 944-1300
info@phoenixcon.com