

# PS-6 - Test plug

3030996

<https://www.phoenixcontact.com/us/products/3030996>

Please be informed that the data shown in this PDF document is generated from our online catalog. Please find the complete data in the user documentation. Our general terms of use for downloads are valid.

Test plug, Modular test plug, number of positions: 1, color: red



## Your advantages

- The test plugs make contact in the function shaft of terminal blocks from the CLIPLINE complete system
- Test adapters can be assembled individually using PS-... modular test plugs

## Commercial data

Item number	3030996
Packing unit	10 pc
Minimum order quantity	10 pc
Sales key	BE29
Product key	BE2Z3X
GTIN	4017918818937
Weight per piece (including packing)	3.4 g
Weight per piece (excluding packing)	3.51 g
Customs tariff number	85366990
Country of origin	PL

# PS-6 - Test plug

3030996

<https://www.phoenixcontact.com/us/products/3030996>

## Technical data

### Product properties

Product type	Test plug terminal block
Number of positions	1

### Electrical properties

Maximum load current	2 A
Max. voltage	250 V

### Connection data

Maximum load current	2 A
Connection method	Spring-cage connection
Conductor cross-section flexible	0.14 mm <sup>2</sup> ... 1 mm <sup>2</sup>
Conductor cross-section rigid	0.14 mm <sup>2</sup> ... 1 mm <sup>2</sup>
Cross section AWG	26 ... 17

### Dimensions

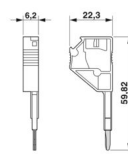
Dimensional drawing	
Width	6.2 mm
Height	22.4 mm
Depth	60 mm

### Material specifications

Color	red (RAL 3001)
Material	PA
Flammability rating according to UL 94	V0

### Environmental and real-life conditions

#### Ambient conditions

Ambient temperature (operation)	-60 °C ... 105 °C (max. short-term operating temperature RTI Elec.)
Ambient temperature (storage/transport)	-25 °C ... 60 °C (for a short time, not exceeding 24 h, -60 °C to +70 °C)
Ambient temperature (assembly)	-5 °C ... 70 °C
Ambient temperature (actuation)	-5 °C ... 70 °C
Permissible humidity (storage/transport)	30 % ... 70 %

# PS-6 - Test plug

3030996

<https://www.phoenixcontact.com/us/products/3030996>



## Drawings

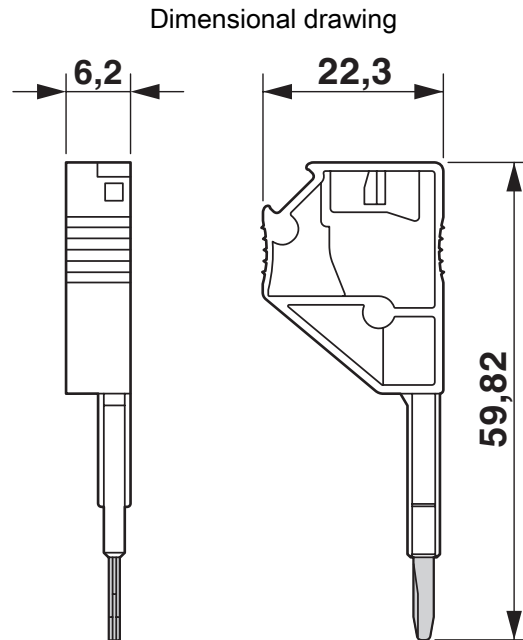

# PS-6 - Test plug

3030996

<https://www.phoenixcontact.com/us/products/3030996>



## Classifications

### ECLASS

ECLASS-13.0	27250304
ECLASS-15.0	27250304

### ETIM

ETIM 10.0	EC002555
-----------	----------

### UNSPSC

UNSPSC 21.0	20122000
-------------	----------

# PS-6 - Test plug



3030996

<https://www.phoenixcontact.com/us/products/3030996>

## Environmental product compliance

### EU RoHS

Fulfills EU RoHS substance requirements	Yes, No exemptions
---	--------------------

### China RoHS

Environment friendly use period (EFUP)	EFUP-E
	No hazardous substances above the limits

### EU REACH SVHC

REACH candidate substance (CAS No.)	No substance above 0.1 wt%
-------------------------------------	----------------------------

### EF3.1 Climate Change

CO2e kg	0.059 kg CO2e
---------	---------------

Phoenix Contact 2026 © - all rights reserved  
<https://www.phoenixcontact.com>

Phoenix Contact USA  
586 Fulling Mill Road  
Middletown, PA 17057, United States  
(+717) 944-1300  
[info@phoenixcon.com](mailto:info@phoenixcon.com)