

UKH 50 - High-current terminal block



3009118

<https://www.phoenixcontact.com/us/products/3009118>

Please be informed that the data shown in this PDF document is generated from our online catalog. Please find the complete data in the user documentation. Our general terms of use for downloads are valid.

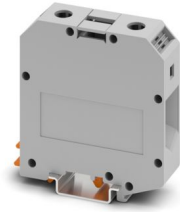

High-current terminal block, nom. voltage: 1000 V, nominal current: 150 A, number of connections: 2, number of positions: 1, connection method: Screw connection, Rated cross section: 50 mm², cross section: 16 mm² - 70 mm², mounting type: NS 35/7,5, NS 35/15, NS 32, NS 35/15-2,3, color: gray

Your advantages

- Reliable cable connection is ensured by three-point centering of the conductor in the prismatic sleeve base
- Low contact resistance of the contact surface due to ribbing
- Screw locking by means of spring-loaded elements in the clamping part

Commercial data

Item number	3009118
Packing unit	10 pc
Minimum order quantity	10 pc
Sales key	BE13
Product key	BE1311
GTIN	4017918091644
Weight per piece (including packing)	120 g
Weight per piece (excluding packing)	113.4 g
Customs tariff number	85369010
Country of origin	IN

UKH 50 - High-current terminal block



3009118

<https://www.phoenixcontact.com/us/products/3009118>

Technical data

Notes

General

Note	For a reliable contact of multi stranded conductors it is recommended to untwist multi stranded conductors.
------	---

Product properties

Product type	High current terminal block
Number of positions	1
Number of connections	2
Number of rows	1
Potentials	1

Insulation characteristics

Overvoltage category	III
Degree of pollution	3

Electrical properties

Rated surge voltage	8 kV
Maximum power dissipation for nominal condition	4.73 W

Connection data

Number of connections per level	2
Nominal cross section	50 mm ²
Connection method	Screw connection
Screw thread	M6
Tightening torque	6 ... 8 Nm
Stripping length	24 mm
Internal cylindrical gage	A10
Connection in acc. with standard	IEC 60947-7-1
Conductor cross-section rigid	16 mm ² ... 70 mm ²
Cross section AWG	4 ... 2/0 (converted acc. to IEC)
Conductor cross-section flexible	25 mm ² ... 70 mm ²
Conductor cross-section, flexible [AWG]	2 ... 2/0 (converted acc. to IEC)
Conductor cross-section flexible (ferrule without plastic sleeve)	16 mm ² ... 50 mm ²
Flexible conductor cross-section (ferrule with plastic sleeve)	16 mm ² ... 50 mm ²
2 conductors with same cross section, rigid	10 mm ² ... 16 mm ²
2 conductors with same cross section, flexible	10 mm ² ... 16 mm ²
2 conductors with same cross section, flexible, with ferrule without plastic sleeve	10 mm ² ... 16 mm ²
Nominal cross section	50 mm ²
Nominal current	150 A
Maximum load current	150 A (with 50 mm ² conductor cross-section)

UKH 50 - High-current terminal block



3009118

<https://www.phoenixcontact.com/us/products/3009118>

Nominal voltage	1000 V
Note	Note: Product releases, connection cross sections and notes on connecting aluminum cables can be found in the download area.

Ex data

Rated data (ATEX/IECEX)

Identification	⊕ II 2 GD Ex eb IIC Gb
Operating temperature range	-60 °C ... 110 °C
Ex-certified accessories	1205082 SZS 1,2X8,0 VDE
	1201659 E/AL-NS 32
	1201662 E/AL-NS 35
List of bridges	Fixed bridge / FBI 2-20-EX / 0201113
	Fixed bridge / FBI 3-20-EX / 0201812
Bridge data	130.5 A (50 mm ²)
Ex temperature increase	40 K (146.5 A / 50 mm ²)
for bridging with bridge	690 V
Rated insulation voltage	630 V
output	(Permanent)

Ex level General

Rated voltage	690 V
Rated current	133 A
Maximum load current	133 A
Contact resistance	0.1 mΩ

Ex connection data General

Torque range	6 Nm ... 8 Nm
Nominal cross section	50 mm ²
Rated cross section AWG	1/0
Connection capacity rigid	16 mm ² ... 50 mm ²
Connection capacity AWG	6 ... 1/0
Connection capacity flexible	25 mm ² ... 50 mm ²
Connection capacity AWG	4 ... 1/0
2 conductors with same cross section, solid	10 mm ² ... 16 mm ²
2 conductors with the same cross-section AWG rigid	8 ... 6
2 conductors with same cross section, stranded	10 mm ² ... 16 mm ²
2 conductors with the same cross-section AWG flexible	8 ... 6

Dimensions

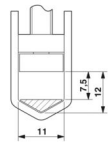
Dimensional drawing	
Width	20 mm

UKH 50 - High-current terminal block



3009118

<https://www.phoenixcontact.com/us/products/3009118>

Height	70.5 mm
Depth	76 mm
Depth on NS 32	81.5 mm
Depth on NS 35/7,5	76.1 mm
Depth on NS 35/15	83.6 mm

Material specifications

Color	gray (RAL 7042)
Flammability rating according to UL 94	V0
Insulating material group	I
Insulating material	PA
Static insulating material application in cold	-60 °C
Relative insulation material temperature index (Elec., UL 746 B)	130 °C
Fire protection for rail vehicles (DIN EN 45545-2) R22	HL 1 - HL 3
Fire protection for rail vehicles (DIN EN 45545-2) R23	HL 1 - HL 3
Fire protection for rail vehicles (DIN EN 45545-2) R24	HL 1 - HL 3
Fire protection for rail vehicles (DIN EN 45545-2) R26	HL 1 - HL 3
Surface flammability NFPA 130 (ASTM E 162)	passed
Specific optical density of smoke NFPA 130 (ASTM E 662)	passed
Smoke gas toxicity NFPA 130 (SMP 800C)	passed

Electrical tests

Surge voltage test

Test voltage setpoint	9.8 kV
Result	Test passed

Temperature-rise test

Requirement temperature-rise test	Increase in temperature \leq 45 K
Result	Test passed
Short-time withstand current 50 mm ²	6 kA
Result	Test passed

Power-frequency withstand voltage

Test voltage setpoint	2.2 kV
Result	Test passed

Mechanical properties

Mechanical data

Open side panel	No
-----------------	----

Mechanical tests

Mechanical strength

Result	Test passed
--------	-------------

UKH 50 - High-current terminal block



3009118

<https://www.phoenixcontact.com/us/products/3009118>

Attachment on the carrier

DIN rail/fixing support	NS 32/NS 35
Test force setpoint	10 N
Result	Test passed

Test for conductor damage and slackening

Rotation speed	10 (+/- 2) rpm
Revolutions	135
Conductor cross-section/weight	16 mm ² / 2.9 kg
	50 mm ² / 9.5 kg
	70 mm ² /10.4 kg
Result	Test passed

Environmental and real-life conditions

Needle-flame test

Time of exposure	30 s
Result	Test passed

Oscillation/broadband noise

Specification	DIN EN 50155 (VDE 0115-200):2018-05
Spectrum	Long life test category 2, bogie-mounted
Frequency	$f_1 = 5 \text{ Hz}$ to $f_2 = 250 \text{ Hz}$
ASD level	6.12 (m/s ²) ² /Hz
Acceleration	3.12g
Test duration per axis	5 h
Test directions	X-, Y- and Z-axis
Result	Test passed

Shocks

Specification	DIN EN 50155 (VDE 0115-200):2022-06
Pulse shape	Half-sine
Acceleration	5g
Shock duration	30 ms
Number of shocks per direction	3
Test directions	X-, Y- and Z-axis (pos. and neg.)
Result	Test passed

Ambient conditions

Ambient temperature (operation)	-60 °C ... 110 °C (Operating temperature range incl. self-heating; for max. short-term operating temperature, see RTI Elec.)
Ambient temperature (storage/transport)	-25 °C ... 60 °C (for a short time, not exceeding 24 h, -60 °C to +70 °C)
Ambient temperature (assembly)	-5 °C ... 70 °C
Ambient temperature (actuation)	-5 °C ... 70 °C
Permissible humidity (operation)	20 % ... 90 %

UKH 50 - High-current terminal block



3009118

<https://www.phoenixcontact.com/us/products/3009118>

Permissible humidity (storage/transport)	30 % ... 70 %
--	---------------

Standards and regulations

Connection in acc. with standard	IEC 60947-7-1
----------------------------------	---------------

Mounting

Mounting type	NS 35/7,5
	NS 35/15
	NS 32
	NS 35/15-2,3

UKH 50 - High-current terminal block

3009118

<https://www.phoenixcontact.com/us/products/3009118>



Drawings

Dimensional drawing

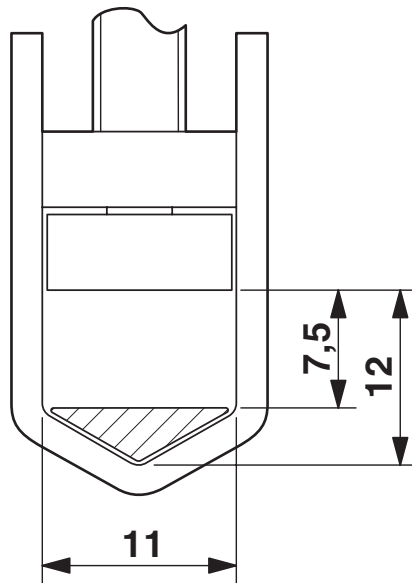

Schematic diagram



Connecting aluminum cables. Further notes can be found in the download area

UKH 50 - High-current terminal block

3009118

<https://www.phoenixcontact.com/us/products/3009118>



Circuit diagram



UKH 50 - High-current terminal block





3009118

<https://www.phoenixcontact.com/us/products/3009118>

Approvals

To download certificates, visit the product detail page: <https://www.phoenixcontact.com/us/products/3009118>

 CSA Approval ID: 13631				
	Nominal voltage U_N	Nominal current I_N	Cross section AWG	Cross section mm^2
B	600 V	150 A	6 - 1/0	-
C	600 V	150 A	6 - 1/0	-

 cULus Recognized Approval ID: E60425				
	Nominal voltage U_N	Nominal current I_N	Cross section AWG	Cross section mm^2
B	600 V	150 A	6 - 1/0	-
Multi-conductor connection	600 V	150 A	8 - 6	-
C	600 V	150 A	6 - 1/0	-
Multi-conductor connection	600 V	150 A	8 - 6	-

 LR Approval ID: LR2420186TA	
---	--

 VDE Zeichengenehmigung Approval ID: 40036368				
	Nominal voltage U_N	Nominal current I_N	Cross section AWG	Cross section mm^2
keine	1000 V	150 A	-	- 50

 IECEE CB Scheme Approval ID: DE1-62936_M1				
	Nominal voltage U_N	Nominal current I_N	Cross section AWG	Cross section mm^2
keine	1000 V	150 A	-	- 50

DNV Approval ID: TAE00001CT	
---------------------------------------	--

UKH 50 - High-current terminal block



3009118

<https://www.phoenixcontact.com/us/products/3009118>



ATEX

Approval ID: KEMA98ATEX1786U



EAC Ex

Approval ID: KZ 7500525010101950



IECEX

Approval ID: KEMA98ATEX1786U



CCC

Approval ID: 2020322313000623



UKCA-EX

Approval ID: DEKRA 21UKEX0307U

UL Comp Hazloc CA US

Approval ID: UL US CA L 192998

	Nominal voltage U_N	Nominal current I_N	Cross section AWG	Cross section mm^2
keine	600 V	150 A	6 - 1/0	-

UKH 50 - High-current terminal block



3009118

<https://www.phoenixcontact.com/us/products/3009118>

Classifications

ECLASS

ECLASS-13.0	27250101
ECLASS-15.0	27250101

ETIM

ETIM 10.0	EC000897
-----------	----------

UNSPSC

UNSPSC 21.0	39121400
-------------	----------

UKH 50 - High-current terminal block



3009118

<https://www.phoenixcontact.com/us/products/3009118>

Environmental product compliance

EU RoHS

Fulfills EU RoHS substance requirements	Yes, No exemptions
---	--------------------

China RoHS

Environment friendly use period (EFUP)	EFUP-E
	No hazardous substances above the limits

EU REACH SVHC

REACH candidate substance (CAS No.)	No substance above 0.1 wt%
-------------------------------------	----------------------------

EF3.1 Climate Change

CO2e kg	0.809 kg CO2e
---------	---------------

Phoenix Contact 2026 © - all rights reserved
<https://www.phoenixcontact.com>

Phoenix Contact USA
586 Fulling Mill Road
Middletown, PA 17057, United States
(+717) 944-1300
info@phoenixcon.com