

FTP-2/14 - Test plug

3001716

<https://www.phoenixcontact.com/us/products/3001716>

Please be informed that the data shown in this PDF document is generated from our online catalog. Please find the complete data in the user documentation. Our general terms of use for downloads are valid.

Test plug, freely configurable, nom. voltage: 400 V, nominal current: 24 A, Rated cross section: 2.5 mm², color: gray



The figure shows the standard item

Your advantages

- Easy and time saving, thanks to functional grouping of switching operations
- Space saving, thanks to offset test socket arrangement
- Cost-effective, thanks to the tailored, modular design and use of standardized CLIPLINE complete accessories
- The integrated, robust switch contact is designed for the most stringent demands, and the use of high-quality materials ensures the transmission of signal currents, even after multiple actuations
- Maximum safety with leading and automatic transformer short circuit
- The automatically generated transformer short circuit and the shock-proof design ensure the highest degree of safety during measurement

Commercial data

Item number	3001716
Packing unit	1 pc
Minimum order quantity	1 pc
Note	Made to order (non-returnable)
Product key	BE6112
GTIN	4046356962858
Weight per piece (including packing)	72.62 g
Weight per piece (excluding packing)	72.6 g
Country of origin	PL

Technical data

Product properties

Product type	Test plug terminal block
Number of positions	14
Pitch	8.2 mm
Number of rows	1
Potentials	14

Insulation characteristics

Overvoltage category	III
----------------------	-----

Electrical properties

Rated surge voltage	4 kV
Maximum power dissipation for nominal condition	1.31 W
Test surge voltage	5 kV

Connection data

Nominal cross section	6 mm ²
Test socket torque	0.5
Note	The conductor cross-section depends on the cable lug used
Conductor cross-section flexible	0.5 mm ² ... 2.5 mm ²
Conductor cross-section, flexible [AWG]	20 ... 14 (converted acc. to IEC)
Nominal cross section	2.5 mm ²
Nominal current	24 A
Maximum load current	24 A
Nominal voltage	400 V AC/DC

Dimensions

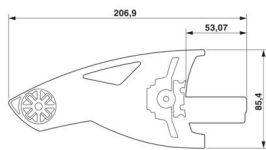
Dimensional drawing	
Width	146.7 mm
Height	86 mm
Pitch	8.2 mm

Material specifications

Color	gray (RAL 7042)
Flammability rating according to UL 94	V0
Insulating material group	I
Insulating material	PA

FTP-2/14 - Test plug



3001716

<https://www.phoenixcontact.com/us/products/3001716>

Mechanical properties

Mechanical data

Open side panel	No
-----------------	----

Environmental and real-life conditions

Ambient conditions

Ambient temperature (operation)	-60 °C ... 85 °C
Ambient temperature (storage/transport)	-25 °C ... 55 °C (for a short time, not exceeding 24 h, -60 °C to +70 °C)
Ambient temperature (assembly)	-5 °C ... 70 °C
Ambient temperature (actuation)	-5 °C ... 70 °C
Permissible humidity (storage/transport)	30 % ... 70 %

Mounting

Mounting type	Insertion in base strip
---------------	-------------------------

FTP-2/14 - Test plug

3001716

<https://www.phoenixcontact.com/us/products/3001716>

Drawings

Dimensional drawing



Circuit diagram



FTP-2/14 - Test plug



3001716

<https://www.phoenixcontact.com/us/products/3001716>

Classifications

ECLASS

ECLASS-13.0	27250304
ECLASS-15.0	27250304

ETIM

ETIM 9.0	EC002555
----------	----------

UNSPSC

UNSPSC 21.0	39121400
-------------	----------

FTP-2/14 - Test plug



3001716

<https://www.phoenixcontact.com/us/products/3001716>

Environmental product compliance

EU RoHS

Fulfills EU RoHS substance requirements	Yes, No exemptions
---	--------------------

China RoHS

Environment friendly use period (EFUP)	EFUP-E
	No hazardous substances above the limits

EU REACH SVHC

REACH candidate substance (CAS No.)	No substance above 0.1 wt%
-------------------------------------	----------------------------

Phoenix Contact 2026 © - all rights reserved
<https://www.phoenixcontact.com>

Phoenix Contact USA
586 Fulling Mill Road
Middletown, PA 17057, United States
(+717) 944-1300
info@phoenixcon.com