

PLC-RSP- 24UC/21-21/RW - Relay module



2987105

<https://www.phoenixcontact.com/us/products/2987105>

Please be informed that the data shown in this PDF document is generated from our online catalog. Please find the complete data in the user documentation. Our general terms of use for downloads are valid.



PLC-INTERFACE for railway applications, consisting of basic terminal block with spring-cage connection and plug-in miniature relay with power contact, range: $0.7 \times U_N$ to $1.25 \times U_N$, temperature class TX: -40°C to $+70^\circ\text{C}$, 2 changeover contacts, input voltage 24 V DC

Your advantages

- Optimum relay operation thanks to wide-range electronics
- Certified in accordance with EN 50155
- Safe isolation between coil and contact side
- Vibration and shock resistance in accordance with EN 50155
- Input voltage range of 0.7 to $1.25 \times U_N$ ($1.4 \times U_N$ briefly)
- Temperature range: -40°C ... $+70^\circ\text{C}$ (short-term 85°C)

Commercial data

Item number	2987105
Packing unit	1 pc
Note	Made to order (non-returnable)
Sales key	C461
Product key	DK622C
GTIN	4046356154161
Weight per piece (including packing)	64.04 g
Weight per piece (excluding packing)	64 g
Customs tariff number	85364190
Country of origin	DE

Technical data

Product properties

Product type	Relay Module
Product family	PLC-INTERFACE
Application	Railway applications
Environment	Attached to the vehicle body
Operating mode	100% operating factor
Mechanical service life	approx. 3×10^7 cycles

Insulation characteristics

Insulation	Basic insulation
Overvoltage category	III
Pollution degree	2

Data management status

Date of last data management	12.09.2025
------------------------------	------------

Electrical properties

Maximum power dissipation for nominal condition	0.5 W
Test voltage (Winding/contact)	5 kV _{rms} (50 Hz, 1 min., winding/contact)
Test voltage (Changeover contact/changeover contact)	2.5 kV _{rms} (50 Hz, 1 min., changeover contact/changeover contact)
Rated insulation voltage	250 V AC
Rated surge voltage	6 kV

Input data

Coil side

Nominal input voltage U_N	24 V DC
Input voltage range	16.8 V DC ... 30 V DC
Input voltage range in reference to U_N	0.7 ... 1.25
Drive and function	monostable
Typical input current at U_N	20 mA
Typical response time	5 ms
Typical release time	11 ms
Coil voltage	12 V DC
Protective circuit	Bridge rectifier; Bridge rectifier
	Freewheeling diode; Freewheeling diode
	Surge protection
	RCZ filter
	Wide-range electronics
Operating voltage display	Yellow LED

Output data

PLC-RSP- 24UC/21-21/RW - Relay module



2987105

<https://www.phoenixcontact.com/us/products/2987105>

Switching

Contact switching type	2 changeover contacts
Type of switch contact	Single contact
Contact material	AgNi
Maximum switching voltage	250 V AC/DC (Separating plate PLC-ATP must be installed for voltages larger than 250 V (L1, L2, L3) between identical terminal blocks in adjacent modules.)
Minimum switching voltage	5 V (at 10 mA)
Limiting continuous current	6 A
Maximum inrush current	15 A (300 ms)
Min. switching current	10 mA (At 5 V)
Interrupting rating (ohmic load) max.	140 W (at 24 V DC) 85 W (at 48 V DC) 60 W (at 60 V DC) 44 W (at 110 V DC) 60 W (at 220 V DC) 1500 VA (for 250 V AC)
Switching capacity	2 A (at 24 V, DC13) 0.2 A (at 250 V, DC13) 3 A (at 24 V, AC15) 3 A (at 120 V, AC15) 3 A (at 250 V, AC15)

Connection data

Coil side

Connection method	Spring-cage connection
Stripping length	8 mm
Conductor cross-section rigid	0.14 mm ² ... 2.5 mm ²
Conductor cross-section flexible	0.14 mm ² ... 2.5 mm ²
Conductor cross-section AWG	26 ... 14

Contact side

Connection method	Spring-cage connection
Stripping length	8 mm
Conductor cross-section rigid	0.14 mm ² ... 2.5 mm ²
Conductor cross-section flexible	0.14 mm ² ... 2.5 mm ²
Conductor cross-section AWG	26 ... 14

Dimensions

Width	14 mm
Height	80 mm
Depth	94 mm

Material specifications

PLC-RSP- 24UC/21-21/RW - Relay module



2987105

<https://www.phoenixcontact.com/us/products/2987105>

Color	green (RAL 6021)
Flammability rating according to UL 94 (Housing)	V0 (Housing)

Environmental and real-life conditions

Ambient conditions

Degree of protection (Relay)	RT III (Relay)
Degree of protection (Relay base)	IP20 (Relay base)
Ambient temperature (operation)	-40 °C ... 70 °C (Temperature class TX)
Ambient temperature (storage/transport)	-40 °C ... 85 °C

Standards and regulations

Standards/regulations	EN 50155 (VDE 0115 part 200)
	IEC 60947-5-1
	EN 61373
	EN 50121

Mounting

Mounting type	DIN rail mounting
Assembly note	in rows with zero spacing
Mounting position	any

Drawings

Diagram

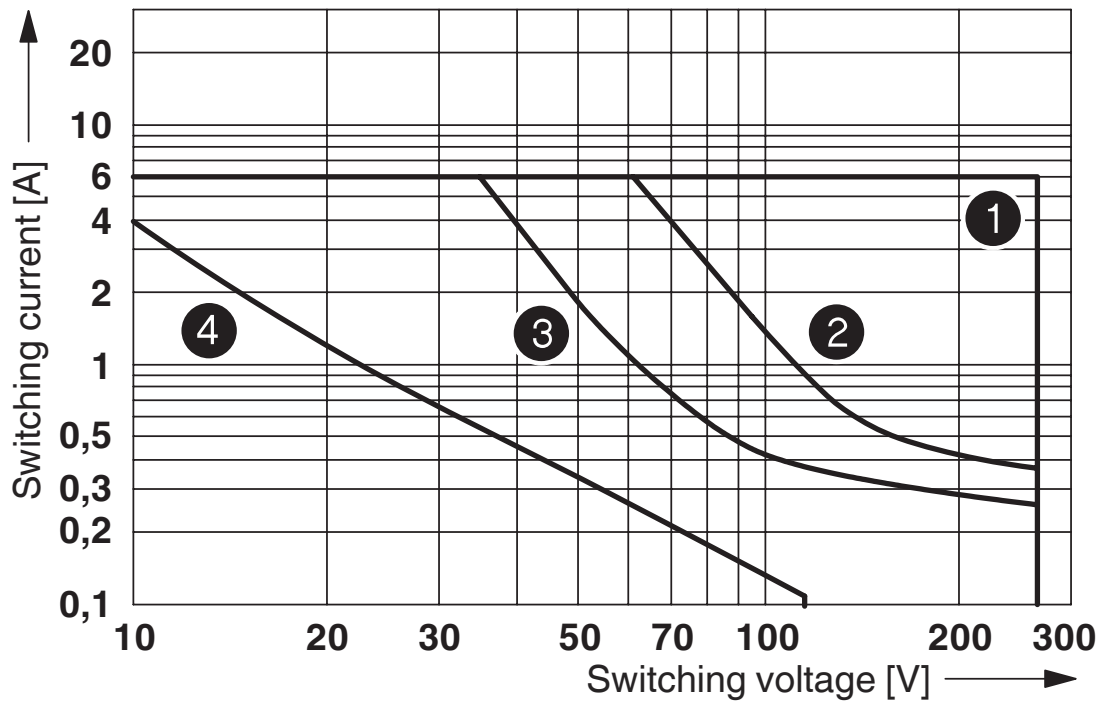

- ① AC, ohmic load
- ② DC, ohmic load, contacts in series
- ③ DC, ohmic load
- ④ DC, L/R = 40 ms

Interrupting rating

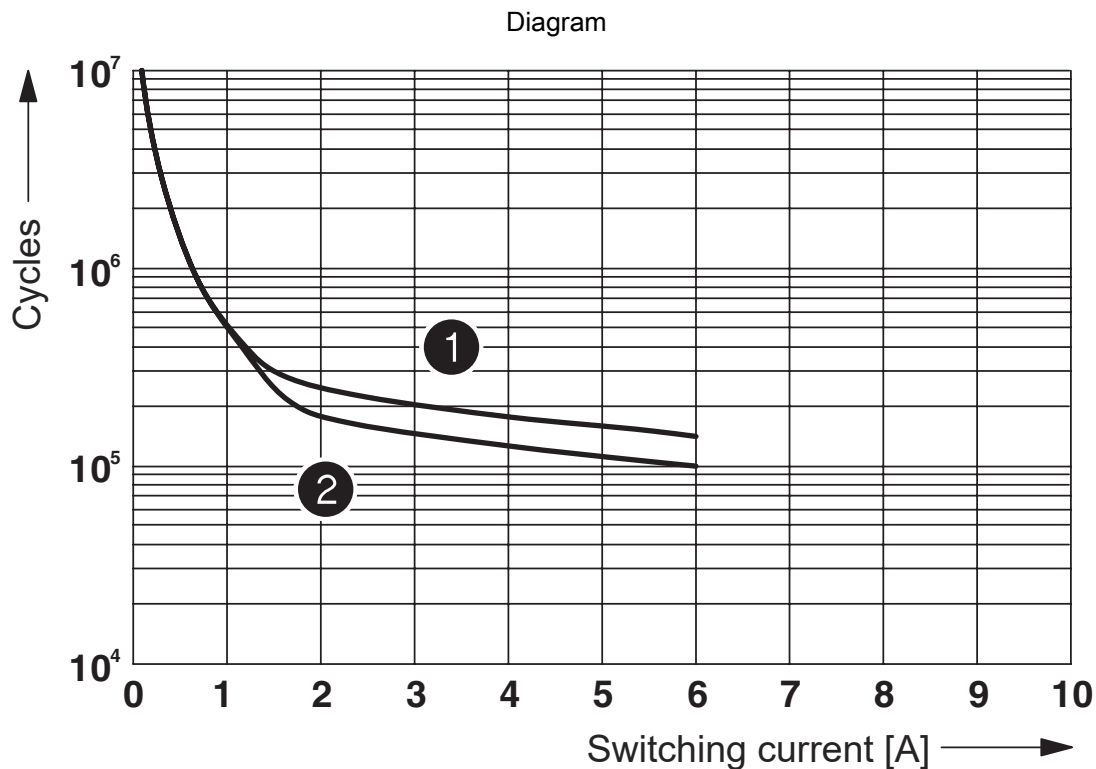

- ① 250 V AC, ohmic load (DC coils)
- ② 250 V AC, ohmic load (AC coils)

Electrical service life

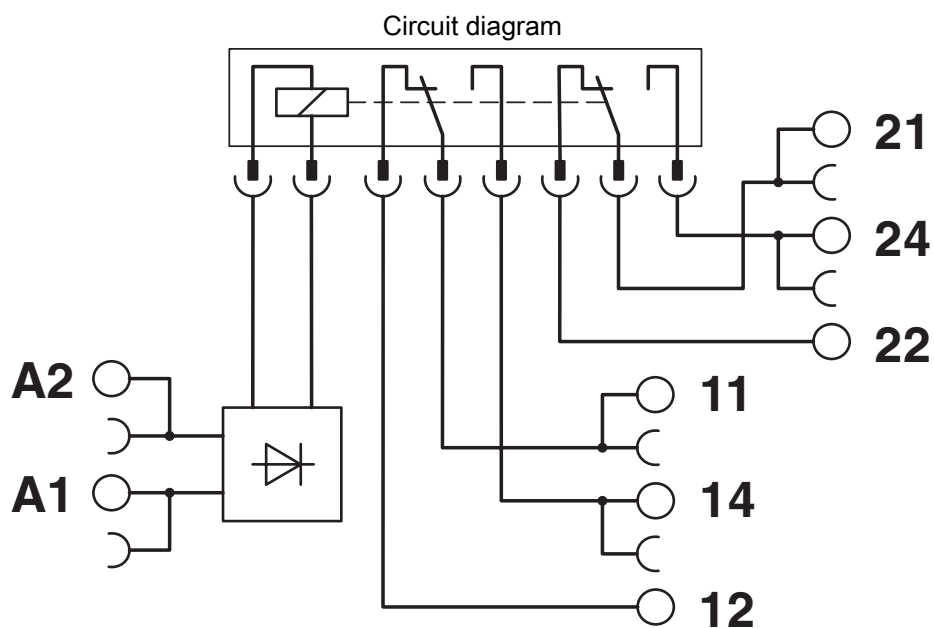

PLC-RSP- 24UC/21-21/RW - Relay module



2987105

<https://www.phoenixcontact.com/us/products/2987105>

Environmental product compliance

China RoHS

Environment friendly use period (EFUP)	EFUP-50
	An article-related China RoHS declaration table can be found in the download area for the respective article under "Manufacturer declaration". For all articles with EFUP-E, no China RoHS declaration table issued and required.

EU REACH SVHC

REACH candidate substance (CAS No.)	No substance above 0.1 wt%
-------------------------------------	----------------------------

Phoenix Contact 2026 © - all rights reserved
<https://www.phoenixcontact.com>

Phoenix Contact USA
586 Fulling Mill Road
Middletown, PA 17057, United States
(+717) 944-1300
info@phoenixcon.com