

EMG 17-OV-230AC/ 60DC/3 - Solid-state relay module



2954206

<https://www.phoenixcontact.com/us/products/2954206>

Please be informed that the data shown in this PDF document is generated from our online catalog. Please find the complete data in the user documentation. Our general terms of use for downloads are valid.



Power solid-state relay, with LED and protective circuit in input and output circuits, input: 230 V AC, output: 12 - 60 V DC/max. 3 A

The figure shows version EMG 17-OV, with DC voltage output, max. 3 A

Commercial data

Item number	2954206
Packing unit	1 pc
Note	Made to order (non-returnable)
Sales key	NULL
Product key	DK61C2
GTIN	4017918084868
Weight per piece (including packing)	95.3 g
Weight per piece (excluding packing)	93.4 g
Customs tariff number	85364900
Country of origin	DE

Technical data

Product properties

Product type	Solid-state relay module
Application	Output function
Operating mode	100% operating factor

Insulation characteristics

Insulation	Basic insulation
------------	------------------

Data management status

Date of last data management	15.09.2025
------------------------------	------------

Electrical properties

Test voltage (Input/output)	3.5 kV AC (Input/output)
-----------------------------	--------------------------

Input data

Nominal input voltage U_N	230 V AC
Input voltage range in reference to U_N	0.9 ... 1.1
Input voltage range	207 V AC ... 253 V AC
Switching threshold "0" signal in reference to U_N	≤ 0.4
Switching threshold "1" signal in reference to U_N	≥ 0.8
Typical input current at U_N	4 mA
Typical response time	3 ms
Typical turn-off time	13 ms
Status display	LED (yellow)
Protective circuit	Reverse polarity protection; Polarity protection diode Surge protection
Transmission frequency	10 Hz

Output data

Design of digital output	electronic
Output nominal voltage	60 V DC
Output voltage range	12 V DC ... 60 V DC
Limiting continuous current	3 A (see derating curve)
Peak offstate voltage	60 V DC
Voltage drop at max. limiting continuous current	1.2 V
Output circuit	2-conductor, floating
Protective circuit	Reverse polarity protection; Polarity protection diode Surge protection

Connection data

Input side

Connection method	Screw connection
-------------------	------------------

EMG 17-OV-230AC/ 60DC/3 - Solid-state relay module



2954206

<https://www.phoenixcontact.com/us/products/2954206>

Stripping length	8 mm
Screw thread	M3
Conductor cross-section rigid	0.2 mm ² ... 4 mm ²
Conductor cross-section flexible	0.2 mm ² ... 2.5 mm ²
Conductor cross-section AWG	24 ... 12

Output side

Connection method	Screw connection
Stripping length	8 mm
Screw thread	M3
Conductor cross-section rigid	0.2 mm ² ... 4 mm ²
Conductor cross-section flexible	0.2 mm ² ... 2.5 mm ²
Conductor cross-section AWG	24 ... 12

Dimensions

Width	17.5 mm
Height	75 mm
Depth	102 mm

Material specifications

Color	green (RAL 6021)
Flammability rating according to UL 94	V0

Environmental and real-life conditions

Ambient conditions

Degree of protection	IP20
Ambient temperature (operation)	-20 °C ... 60 °C
Ambient temperature (storage/transport)	-20 °C ... 70 °C

Standards and regulations

Standards/regulations	IEC 60664
	EN 50178

Mounting

Assembly note	in rows with zero spacing
Mounting position	any

Drawings

Diagram



- ① In rows with zero spacing
- ② stand-alone device

Circuit diagram

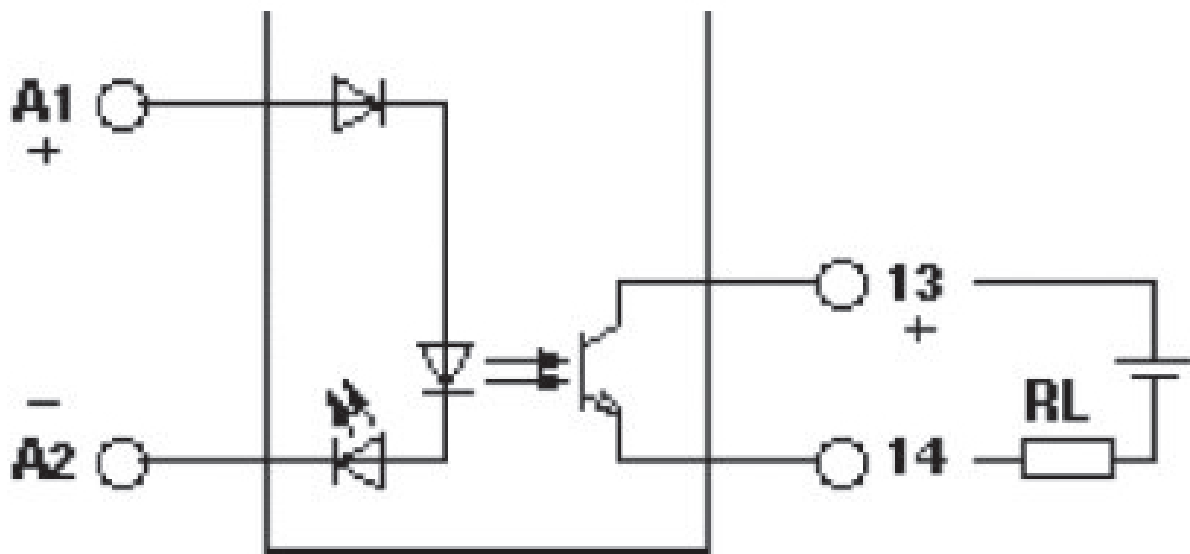

2954206

<https://www.phoenixcontact.com/us/products/2954206>

Environmental product compliance

China RoHS

Environment friendly use period (EFUP)	EFUP-50
	An article-related China RoHS declaration table can be found in the download area for the respective article under "Manufacturer declaration". For all articles with EFUP-E, no China RoHS declaration table issued and required.

EU REACH SVHC

REACH candidate substance (CAS No.)	No substance above 0.1 wt%
-------------------------------------	----------------------------

Phoenix Contact 2026 © - all rights reserved
<https://www.phoenixcontact.com>

Phoenix Contact USA
586 Fulling Mill Road
Middletown, PA 17057, United States
(+717) 944-1300
info@phoenixcon.com