

DT-LAN-CAT.6A - Surge protection device



2908726

<https://www.phoenixcontact.com/us/products/2908726>

Please be informed that the data shown in this PDF document is generated from our online catalog. Please find the complete data in the user documentation. Our general terms of use for downloads are valid.



Surge protection in accordance with Class E_A (CAT6_A), for Gigabit Ethernet (up to 10 Gbps), token ring, FDDI/CDDI, ISDN, DS1. Suitable for Power over Ethernet (PoE++/4PPoE) "Mode A" and "Mode B". RJ45 intermediate plug with separate grounding cable and ground connection snap-on foot for NS 35 DIN rails.

Your advantages

- Can be installed in a control cabinet by removing the ground connection adapter
- Suitable for category 6 high-speed data networks

Commercial data

Item number	2908726
Packing unit	1 pc
Minimum order quantity	1 pc
Sales key	CL24
Product key	CL3112
GTIN	4055626345963
Weight per piece (including packing)	314.857 g
Weight per piece (excluding packing)	314.1 g
Customs tariff number	85363010
Country of origin	DE

DT-LAN-CAT.6A - Surge protection device

2908726

<https://www.phoenixcontact.com/us/products/2908726>

Technical data

Product properties

Product type	Surge protection for information technology
Product family	DATATRAB
IEC test classification	B2
	C1
	C2
	C3
	D1
Type	Attachment plug for DIN rail mounting
Number of positions	8
Surge protection fault message	none
Wire pairs per module	4

Insulation characteristics

Overvoltage category	II
Pollution degree	2

Connection data

Connection method	RJ45
-------------------	------

Dimensions

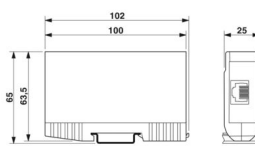
Dimensional drawing	
Width	25 mm
Height	102 mm
Depth	63.5 mm

Material specifications

Color	silver-colored
Housing material	Die-cast zinc

Mechanical properties

Mechanical data

Open side panel	No
-----------------	----

Protective circuit

Direction of action	Line-Line & Line-Ground/Shield
---------------------	--------------------------------

DT-LAN-CAT.6A - Surge protection device



2908726

<https://www.phoenixcontact.com/us/products/2908726>

Maximum continuous voltage U_C (line-line)	≤ 3.3 V DC (± 60 V DC/PoE+)
Rated current	≤ 1.5 A (25 °C)
Operating effective current I_C at U_C	≤ 1 μ A
Protective conductor current I_{PE}	≤ 400 μ A
Nominal discharge current I_n (8/20) μ s (line-line)	100 A
Nominal discharge current I_n (8/20) μ s (line-ground)	2 kA (per signal pair)
Pulse discharge current I_{imp} (10/350) μ s (line-earth)	1 kA
Total discharge current I_{Total} (8/20) μ s	10 kA
Nominal pulse current I_{an} (10/700) μ s (line-line)	≤ 40 A
Nominal pulse current I_{an} (10/700) μ s (line-earth)	≤ 160 A
Output voltage limitation at 1 kV/ μ s (line-line) spike	≤ 85 V (PoE)
Output voltage limitation at 1 kV/ μ s (line-earth) spike	≤ 700 V
Output voltage limitation at 1 kV/ μ s (line-line) static	≤ 9 V
Output voltage limitation at 1 kV/ μ s (line-earth) static	≤ 700 V
Residual voltage at I_n (conductor-conductor)	≤ 15 V
	≤ 100 V (PoE)
Voltage protection level U_p (line-line)	≤ 9 V (B2 - 1 kV / 25 A)
	≤ 100 V (B2 - 1 kV / 25 A - PoE)
	≤ 12 V (C3 - 20 A)
Voltage protection level U_p (line-earth)	≤ 900 V (B2 - 4 kV / 100 A)
	≤ 700 V (C2 - 4 kV / 2 kA)
	≤ 1 kV (C3 - 80 A)
Response time t_A (line-line)	≤ 1 ns
Response time t_A (line-earth)	≤ 100 ns
Input attenuation aE, sym.	≤ 1 dB (up to 100 MHz/direct measuring)
	≤ 1 dB (up to 250 MHz/direct measuring)
	≤ 3 dB (up to 500 MHz/direct measuring)
Near-end crosstalk attenuation	≥ 35 dB (250 MHz/100 Ω /link)
	≥ 45 dB (100 MHz / 100 Ω / Link)
	≥ 27 dB (500 MHz / 100 Ω / Link)
	≥ 39 dB (250 MHz/100 Ω /direct measuring)
Capacity (Core-Core)	typ. 12 pF (f= 1 MHz / VR= 0 V)
Capacity (Core-Earth)	typ. 2 pF (f= 1 MHz / VR= 0 V)
Surge protection fault message	none
Impulse durability (line-line)	B2 - 1 kV / 25 A
	C3 - 20 A
Impulse durability (line-earth)	B2 - 4 kV / 100 A
	C2 - 4 kV / 2 kA
	C3 - 80 A
	D1 - 1 kA

Environmental and real-life conditions

Ambient conditions

DT-LAN-CAT.6A - Surge protection device



2908726

<https://www.phoenixcontact.com/us/products/2908726>

Degree of protection	IP20
Ambient temperature (operation)	-40 °C ... 70 °C
Ambient temperature (storage/transport)	-40 °C ... 70 °C
Altitude	≤ 4000 m (amsl)
Permissible humidity (operation)	5 % ... 85 %

Standards and regulations

Standards/specifications	IEC 61643-21
Note	2000 + corrigendum 2001 + A1:2008, modified + A2:2012
Standards/specifications	EN 61643-21
Note	2001 + A1:2009 + A2:2013
Standards/specifications	EN 50173-1
Note	2002
Standards/specifications	ISO/IEC 11801-Am.1
Note	2006

Mounting

Mounting type	Connection-specific attachment plug and DIN rail, 35 mm
---------------	---

DT-LAN-CAT.6A - Surge protection device



2908726

<https://www.phoenixcontact.com/us/products/2908726>

Drawings

Dimensional drawing

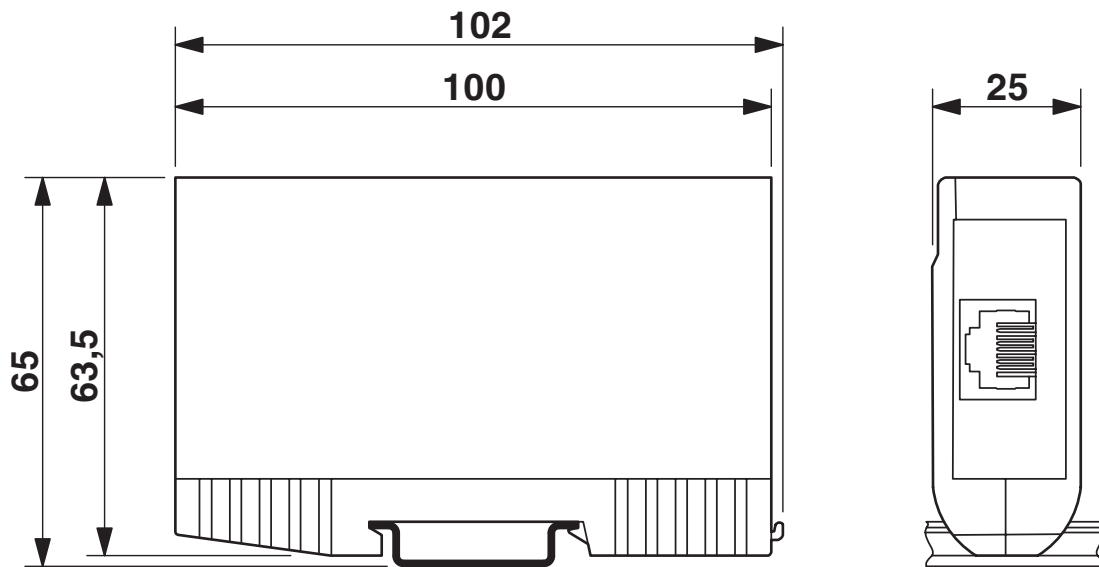

Circuit diagram

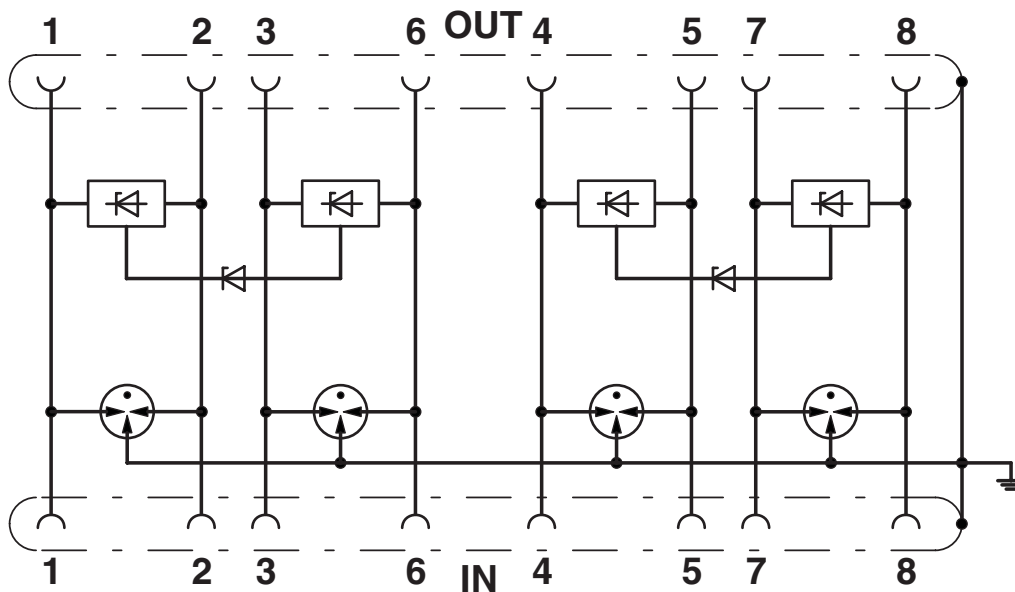

DT-LAN-CAT.6A - Surge protection device



2908726

<https://www.phoenixcontact.com/us/products/2908726>

Classifications

ECLASS

ECLASS-13.0	27171503
ECLASS-15.0	27171503

ETIM

ETIM 10.0	EC001466
-----------	----------

UNSPSC

UNSPSC 21.0	39121600
-------------	----------

DT-LAN-CAT.6A - Surge protection device



2908726

<https://www.phoenixcontact.com/us/products/2908726>

Environmental product compliance

EU RoHS

Fulfills EU RoHS substance requirements	Yes
Exemption	6(a)-I, 7(a), 7(c)-I

China RoHS

Environment friendly use period (EFUP)	EFUP-50
	An article-related China RoHS declaration table can be found in the download area for the respective article under "Manufacturer declaration". For all articles with EFUP-E, no China RoHS declaration table issued and required.

EU REACH SVHC

REACH candidate substance (CAS No.)	Lead(CAS: 7439-92-1)
-------------------------------------	----------------------

Phoenix Contact 2026 © - all rights reserved
<https://www.phoenixcontact.com>

Phoenix Contact USA
586 Fulling Mill Road
Middletown, PA 17057, United States
(+717) 944-1300
info@phoenixcon.com