

# TMC 82B 08A - Miniature Circuit Breaker



2907510

<https://www.phoenixcontact.com/us/products/2907510>

Please be informed that the data shown in this PDF document is generated from our online catalog. Please find the complete data in the user documentation. Our general terms of use for downloads are valid.



Thermal-magnetic Miniature Circuit Breaker, 2-position, use: Branch Circuit Protection (UL 489), for protection against overload with a breaking capacity of 10 kA, tripping characteristic: B, mounting type: NS 35/..., rated current: 8 A

## Product description

CCC marking on the product is only present on products purchased from Phoenix Contact China.

## Your advantages

- Can be used worldwide due to international approvals
- Suitable for various grid types, as it is available in 1-, 2-, 3-pos. versions
- Ideally coordinated protection due to various tripping characteristics and a wide selection of nominal currents
- Reduced inventory because of suitability for AC and DC applications
- Optional accessories enable remote control and monitoring

## Commercial data

Item number	2907510
Packing unit	1 pc
Minimum order quantity	1 pc
Sales key	CL08
Product key	CLA125
GTIN	4055626215358
Weight per piece (including packing)	222.222 g
Weight per piece (excluding packing)	262 g
Customs tariff number	85362010
Country of origin	CN

# TMC 82B 08A - Miniature Circuit Breaker



2907510

<https://www.phoenixcontact.com/us/products/2907510>

## Technical data

### Product properties

Product type	Circuit breakers
Product family	TMC 8
Type	DIN rail module, one-piece
Number of positions	2
Mechanical service life	20000
Special properties	Branch Circuit Protection (UL 489), for protection against overload with a breaking capacity of 10 kA Thermal-magnetic

### Electrical properties

Service life electrical	6000
-------------------------	------

### General

Operating voltage	277 V AC (277/480Y, 240D, 120/240S) 125 V DC (two poles in series)
Rated current $I_N$	8 A
Tripping method	TM (thermal-magnetic)
Rated short-circuit switching capacity $I_{cn}$	10 kA (IC)
Fuse	B
Contact switching type	none

### Connection data

Conductor cross-section rigid	1 mm <sup>2</sup> ... 35 mm <sup>2</sup>
Cross section AWG	18 ... 2 (converted acc. to IEC)
Conductor cross-section flexible	1 mm <sup>2</sup> ... 35 mm <sup>2</sup>
Connection method	Screw connection
Tightening torque, min	2 Nm
Tightening torque	2 Nm
Stripping length	11 mm ... 12 mm
Conductor cross-section flexible max.	35 mm <sup>2</sup>
Conductor cross-section, rigid max.	35 mm <sup>2</sup>
Conductor cross-section flexible	1 mm <sup>2</sup> ... 35 mm <sup>2</sup>
Conductor cross-section rigid	1 mm <sup>2</sup> ... 35 mm <sup>2</sup>
Conductor cross-section AWG	18 ... 2

### Dimensions

Dimensional drawing	
Width	35.3 mm
Height	116 mm

# TMC 82B 08A - Miniature Circuit Breaker



2907510

<https://www.phoenixcontact.com/us/products/2907510>

Depth	76.6 mm (incl. DIN rail 7.5 mm)
-------	---------------------------------

## Material specifications

Color	light gray (RAL 7035)
	gray (RAL 7042)

## Environmental and real-life conditions

### Ambient conditions

Ambient temperature (operation)	-35 °C ... 70 °C
Humidity test	48 h, 95% RH, 40°C (IEC 60068-2-78)
Shock (operation)	30g (11 ms) (IEC 60068-2-11)
Vibration (operation)	±0,38 mm (10 Hz ... 57 Hz), 5g (57 Hz ... 500 Hz) (IEC 60068-2-6, Fc, sine)

## Standards and regulations

Standards/specifications	UL 489
Standards/specifications	IEC 60947-2

## Mounting

Mounting type	NS 35/...
---------------	-----------

# TMC 82B 08A - Miniature Circuit Breaker

2907510

<https://www.phoenixcontact.com/us/products/2907510>

## Drawings

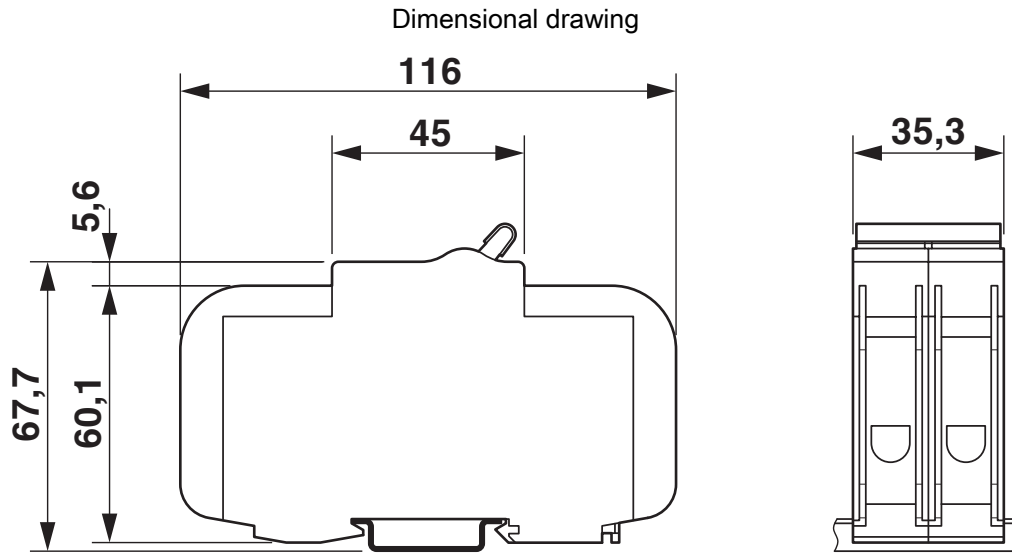

Diagram



# TMC 82B 08A - Miniature Circuit Breaker



2907510

<https://www.phoenixcontact.com/us/products/2907510>

## Approvals

To download certificates, visit the product detail page: <https://www.phoenixcontact.com/us/products/2907510>



**UL Listed**

Approval ID: FILE E 320373



**cUL Listed**

Approval ID: FILE E 320373



**TÜV Rheinland**

Approval ID: R 50531587



**CCC**

Approval ID: 2024010307673885

# TMC 82B 08A - Miniature Circuit Breaker



2907510

<https://www.phoenixcontact.com/us/products/2907510>

## Classifications

### ECLASS

ECLASS-13.0	27140401
ECLASS-15.0	27140401

### ETIM

ETIM 10.0	EC003538
-----------	----------

### UNSPSC

UNSPSC 21.0	39121410
-------------	----------

# TMC 82B 08A - Miniature Circuit Breaker



2907510

<https://www.phoenixcontact.com/us/products/2907510>

## Environmental product compliance

### EU RoHS

Fulfills EU RoHS substance requirements	Yes, No exemptions
-----------------------------------------	--------------------

### China RoHS

Environment friendly use period (EFUP)	EFUP-E
	No hazardous substances above the limits

### EU REACH SVHC

REACH candidate substance (CAS No.)	No substance above 0.1 wt%
-------------------------------------	----------------------------

### EF3.1 Climate Change

CO2e kg	7.827 kg CO2e
---------	---------------

Phoenix Contact 2026 © - all rights reserved  
<https://www.phoenixcontact.com>

Phoenix Contact USA  
586 Fulling Mill Road  
Middletown, PA 17057, United States  
(+717) 944-1300  
[info@phoenixcon.com](mailto:info@phoenixcon.com)