

HMC 11 120AC 3A C1D2 - Hydraulic-magnetic circuit breaker



2907193

<https://www.phoenixcontact.com/us/products/2907193>

Please be informed that the data shown in this PDF document is generated from our online catalog. Please find the complete data in the user documentation. Our general terms of use for downloads are valid.

HMC series of supplemental circuit protector modules, 3 A rating



Your advantages

- Optional T-bus for reduced wiring
- UL recognized for hazardous locations Class I, Division 2, Groups A, B, C, and D
- Dual-rated for 50 V DC and 120 V AC
- Hydraulic-magnetic technology provides extended temperature stability

Commercial data

Item number	2907193
Packing unit	1 pc
Minimum order quantity	1 pc
Sales key	CL12
Product key	CLA181
GTIN	4055626342368
Weight per piece (including packing)	222.222 g
Weight per piece (excluding packing)	11.793 g
Country of origin	MX

HMC 11 120AC 3A C1D2 - Hydraulic-magnetic circuit breaker

2907193

<https://www.phoenixcontact.com/us/products/2907193>

Technical data

Notes

Trade restriction

CE note	The products are offered exclusively for export outside the EU and the European Economic Area.
---------	--

Product properties

Product type	Device circuit breakers
Product family	HMC
Number of positions	1
Number of rows	1

Electrical properties

General

Nominal current I_N	3 A
Rated voltage	120 V AC (50/60 Hz)
	50 V DC
Rated short-circuit switching capacity I_{cn}	1 kA (SCCR)
Fuse	Hydraulic magnetic circuit breaker

Connection data

Connection method	Screw connection with tension sleeve
Screw thread	M3
Tightening torque	0.5 ... 0.6 Nm
Stripping length	7 mm
Conductor cross-section rigid	0.2 mm ² ... 2.5 mm ²
Cross section AWG	24 ... 12 (converted acc. to IEC)
Conductor cross-section flexible	0.2 mm ² ... 2.5 mm ²
Conductor cross-section, flexible [AWG]	24 ... 12 (converted acc. to IEC)

Dimensions

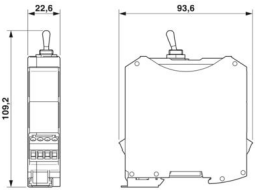
Dimensional drawing	
Width	22.6 mm
Height	93.6 mm
Depth	109.2 mm

Material specifications

HMC 11 120AC 3A C1D2 - Hydraulic-magnetic circuit breaker



2907193

<https://www.phoenixcontact.com/us/products/2907193>

Color	light gray (RAL 7035)
Material	Polyamide
Flammability rating according to UL 94	V0

Environmental and real-life conditions

Ambient conditions

Ambient temperature (operation)	-40 °C ... 65 °C
Ambient temperature (storage/transport)	-40 °C ... 65 °C

Standards and regulations

Standards/specifications	UL 1077
--------------------------	---------

Mounting

Mounting type	DIN rail: 35 mm
Mounting position	As desired on 35 mm DIN rail in acc. with EN 60715

HMC 11 120AC 3A C1D2 - Hydraulic-magnetic circuit breaker

2907193

<https://www.phoenixcontact.com/us/products/2907193>

Drawings

Dimensional drawing

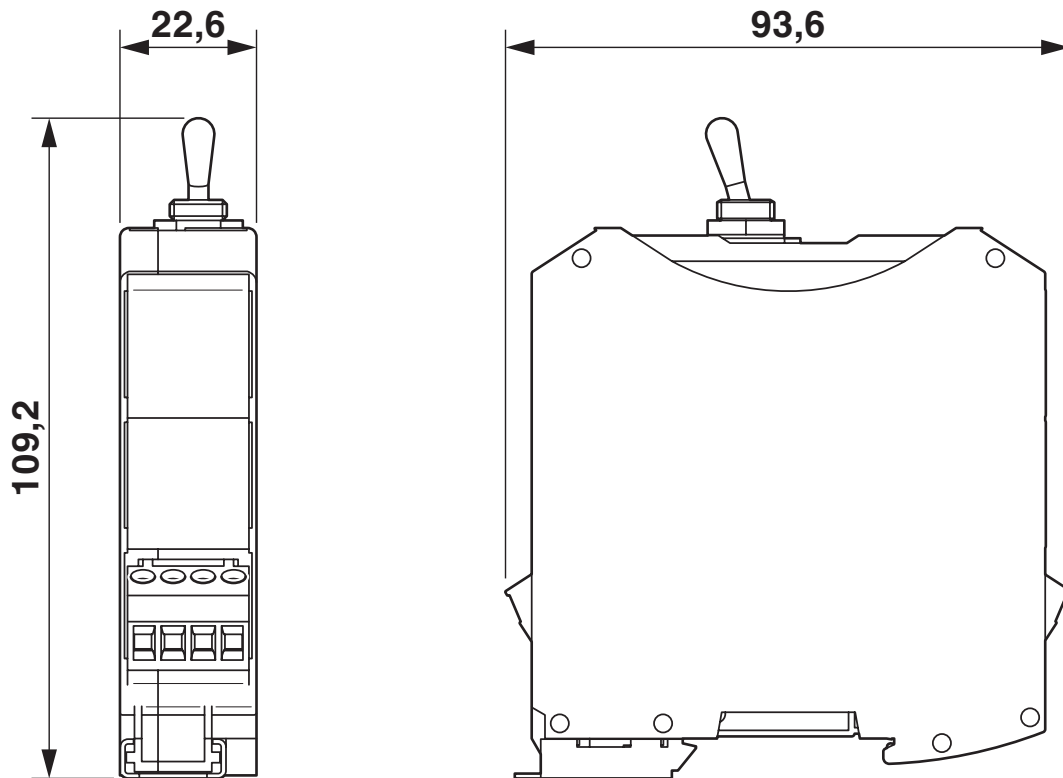

HMC 11 120AC 3A C1D2 - Hydraulic-magnetic circuit breaker



2907193

<https://www.phoenixcontact.com/us/products/2907193>

Diagram



HMC 11 120AC 3A C1D2 - Hydraulic-magnetic circuit breaker



2907193

<https://www.phoenixcontact.com/us/products/2907193>

Approvals

To download certificates, visit the product detail page: <https://www.phoenixcontact.com/us/products/2907193>



cUL Recognized
Approval ID: FILE E 140459



UL Recognized
Approval ID: FILE E 140459



cUL Recognized
Approval ID: FILE E 360692



UL Recognized
Approval ID: FILE E 360692

HMC 11 120AC 3A C1D2 - Hydraulic-magnetic circuit breaker



2907193

<https://www.phoenixcontact.com/us/products/2907193>

Classifications

ECLASS

ECLASS-13.0	27140401
ECLASS-15.0	27140401

HMC 11 120AC 3A C1D2 - Hydraulic-magnetic circuit breaker



2907193

<https://www.phoenixcontact.com/us/products/2907193>

Environmental product compliance

EU RoHS

Fulfills EU RoHS substance requirements	Not applicable, Not qualified for the European market
---	---

China RoHS

Environment friendly use period (EFUP)	EFUP-50
	An article-related China RoHS declaration table can be found in the download area for the respective article under "Manufacturer declaration". For all articles with EFUP-E, no China RoHS declaration table issued and required.

EU REACH SVHC

REACH candidate substance (CAS No.)	No substance above 0.1 wt%
-------------------------------------	----------------------------

Phoenix Contact 2026 © - all rights reserved

<https://www.phoenixcontact.com>

Phoenix Contact USA
586 Fulling Mill Road
Middletown, PA 17057, United States
(+717) 944-1300
info@phoenixcon.com