

HMC 11 120AC 1A C1D2 - Hydraulic-magnetic circuit breaker



2907191

<https://www.phoenixcontact.com/us/products/2907191>

Please be informed that the data shown in this PDF document is generated from our online catalog. Please find the complete data in the user documentation. Our general terms of use for downloads are valid.

HMC series of supplemental circuit protector modules, 1 A rating



Your advantages

- Optional T-bus for reduced wiring
- UL recognized for hazardous locations Class I, Division 2, Groups A, B, C, and D
- Dual-rated for 50 V DC and 120 V AC
- Hydraulic-magnetic technology provides extended temperature stability

Commercial data

| | |
|--------------------------------------|---------------|
| Item number | 2907191 |
| Packing unit | 1 pc |
| Minimum order quantity | 1 pc |
| Sales key | CL12 |
| Product key | CLA181 |
| GTIN | 4055626342344 |
| Weight per piece (including packing) | 222.222 g |
| Weight per piece (excluding packing) | 222.222 g |
| Country of origin | MX |

HMC 11 120AC 1A C1D2 - Hydraulic-magnetic circuit breaker



2907191

<https://www.phoenixcontact.com/us/products/2907191>

Technical data

Notes

Trade restriction

| | |
|---------|--|
| CE note | The products are offered exclusively for export outside the EU and the European Economic Area. |
|---------|--|

Product properties

| | |
|---------------------|-------------------------|
| Product type | Device circuit breakers |
| Product family | HMC |
| Number of positions | 1 |
| Number of rows | 1 |

Electrical properties

General

| | |
|---|------------------------------------|
| Nominal current I_N | 1 A |
| Rated voltage | 120 V AC (50/60 Hz) |
| | 50 V DC |
| Rated short-circuit switching capacity I_{cn} | 1 kA (SCCR) |
| Fuse | Hydraulic magnetic circuit breaker |

Connection data

| | |
|---|---|
| Connection method | Screw connection with tension sleeve |
| Screw thread | M3 |
| Tightening torque | 0.5 ... 0.6 Nm |
| Stripping length | 7 mm |
| Conductor cross-section rigid | 0.2 mm ² ... 2.5 mm ² |
| Cross section AWG | 24 ... 12 (converted acc. to IEC) |
| Conductor cross-section flexible | 0.2 mm ² ... 2.5 mm ² |
| Conductor cross-section, flexible [AWG] | 24 ... 12 (converted acc. to IEC) |

Dimensions

| | |
|---------------------|----------|
| Dimensional drawing | |
| Width | 22.6 mm |
| Height | 93.6 mm |
| Depth | 109.2 mm |

Material specifications

HMC 11 120AC 1A C1D2 - Hydraulic-magnetic circuit breaker



2907191

<https://www.phoenixcontact.com/us/products/2907191>

| | |
|--|-----------------------|
| Color | light gray (RAL 7035) |
| Material | Polyamide |
| Flammability rating according to UL 94 | V0 |

Environmental and real-life conditions

Ambient conditions

| | |
|---|------------------|
| Ambient temperature (operation) | -40 °C ... 65 °C |
| Ambient temperature (storage/transport) | -40 °C ... 65 °C |

Standards and regulations

| | |
|--------------------------|---------|
| Standards/specifications | UL 1077 |
|--------------------------|---------|

Mounting

| | |
|-------------------|--|
| Mounting type | DIN rail: 35 mm |
| Mounting position | As desired on 35 mm DIN rail in acc. with EN 60715 |

HMC 11 120AC 1A C1D2 - Hydraulic-magnetic circuit breaker



2907191

<https://www.phoenixcontact.com/us/products/2907191>

Drawings

Dimensional drawing

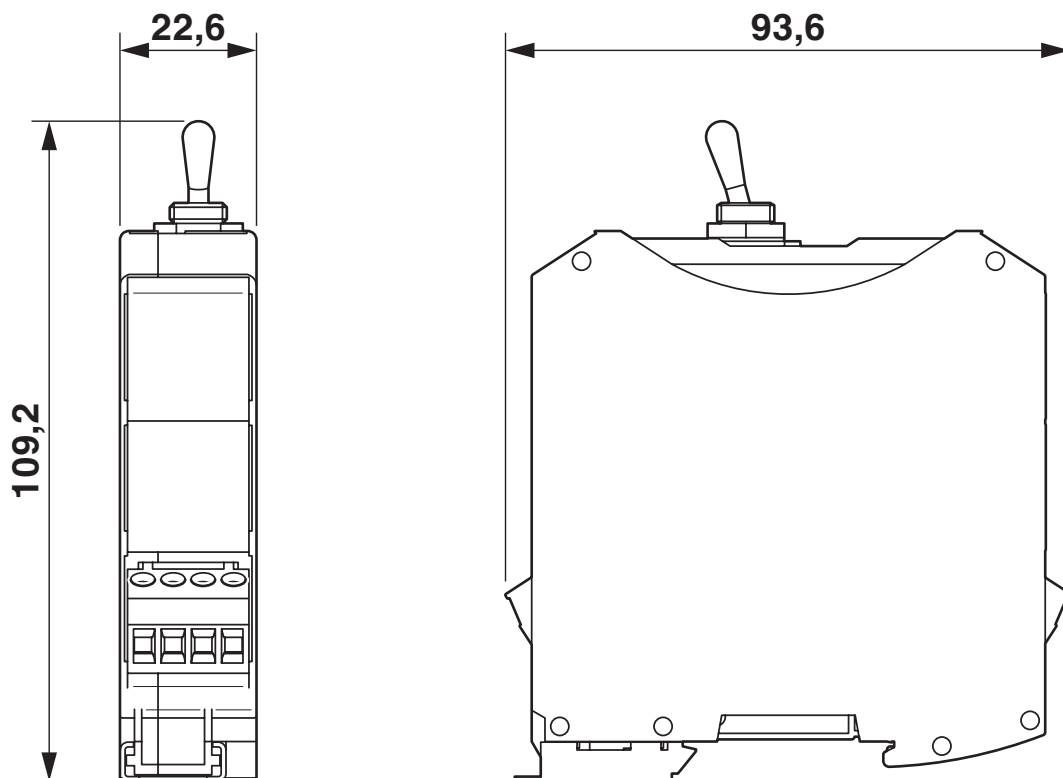

HMC 11 120AC 1A C1D2 - Hydraulic-magnetic circuit breaker



2907191

<https://www.phoenixcontact.com/us/products/2907191>

Diagram

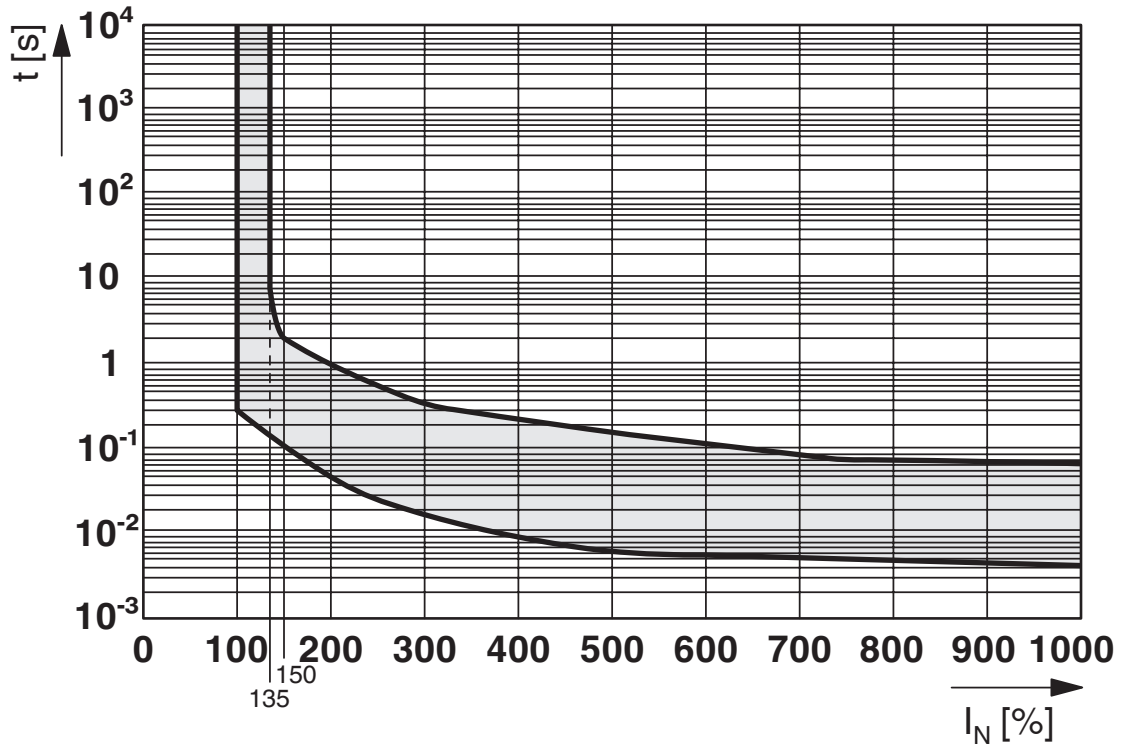

HMC 11 120AC 1A C1D2 - Hydraulic-magnetic circuit breaker



2907191

<https://www.phoenixcontact.com/us/products/2907191>

Approvals

To download certificates, visit the product detail page: <https://www.phoenixcontact.com/us/products/2907191>



cUL Recognized
Approval ID: FILE E 140459



UL Recognized
Approval ID: FILE E 140459



cUL Recognized
Approval ID: FILE E 360692



UL Recognized
Approval ID: FILE E 360692

HMC 11 120AC 1A C1D2 - Hydraulic-magnetic circuit breaker



2907191

<https://www.phoenixcontact.com/us/products/2907191>

Classifications

ECLASS

| | |
|-------------|----------|
| ECLASS-13.0 | 27140401 |
| ECLASS-15.0 | 27140401 |

HMC 11 120AC 1A C1D2 - Hydraulic-magnetic circuit breaker



2907191

<https://www.phoenixcontact.com/us/products/2907191>

Environmental product compliance

EU RoHS

| | |
|---|---|
| Fulfills EU RoHS substance requirements | Not applicable, Not qualified for the European market |
|---|---|

China RoHS

| | |
|--|---|
| Environment friendly use period (EFUP) | EFUP-50 |
| | An article-related China RoHS declaration table can be found in the download area for the respective article under "Manufacturer declaration". For all articles with EFUP-E, no China RoHS declaration table issued and required. |

EU REACH SVHC

| | |
|-------------------------------------|----------------------------|
| REACH candidate substance (CAS No.) | No substance above 0.1 wt% |
|-------------------------------------|----------------------------|

Phoenix Contact 2026 © - all rights reserved

<https://www.phoenixcontact.com>

Phoenix Contact USA
586 Fulling Mill Road
Middletown, PA 17057, United States
(+717) 944-1300
info@phoenixcon.com