

UM-FLK10-5RSC-24DC/DO/ROC800 - Active module



2905960

<https://www.phoenixcontact.com/us/products/2905960>

Please be informed that the data shown in this PDF document is generated from our online catalog. Please find the complete data in the user documentation. Our general terms of use for downloads are valid.

VARIOFACE module intended for use with the Emerson ROC800-series digital output modules.
UL recognized to Class I, Div. 2.



Your advantages

- Three-level screw terminals for field wiring
- Per channel pluggable fusing, TE5 style
- FLK10 connection on the control side
- UM-PRO housing
- Per channel blown fuse indication
- FLK10 connection on the control side
- Tested for continuity

Commercial data

Item number	2905960
Packing unit	1 pc
Minimum order quantity	1 pc
Sales key	C421
Product key	DK2B9K
GTIN	4055626047478
Weight per piece (including packing)	268.5 g
Weight per piece (excluding packing)	268.5 g
Customs tariff number	85369010
Country of origin	CZ

2905960

<https://www.phoenixcontact.com/us/products/2905960>

Technical data

Product properties

Product type	Interface module
Product family	VARIOFACE

Electrical properties

Supported controller: EMERSON ROC800

Suitable I/O card	ROC800 DO
-------------------	-----------

Connection data

Controller level

Connection method	IDC/FLK pin strip
Number of connections	1
Number of positions	10
Pitch	2.54 mm

Field level

Connection method	Screw connection
Stripping length	8 mm
Screw thread	M3
Number of connections	18
Conductor cross-section rigid	0.2 mm ² ... 4 mm ²
Conductor cross-section flexible	0.2 mm ² ... 2.5 mm ²
Conductor cross-section AWG	24 ... 12

Supply

Connection method	Screw connection
Stripping length	8 mm
Screw thread	M3
Number of connections	2
Conductor cross-section rigid	0.2 mm ² ... 4 mm ²
Conductor cross-section flexible	0.2 mm ² ... 2.5 mm ²
Conductor cross-section AWG	24 ... 12

Signaling

Status display present	yes
------------------------	-----

Dimensions

UM-FLK10-5RSC-24DC/DO/ROC800 - Active module



2905960

<https://www.phoenixcontact.com/us/products/2905960>

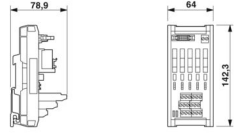
Dimensional drawing	
Width	64 mm
Height	142.3 mm
Depth	78.9 mm

Environmental and real-life conditions

Ambient conditions

Ambient temperature (operation)	-40 °C ... 60 °C
Ambient temperature (storage/transport)	-40 °C ... 70 °C

Mounting

Mounting type	DIN rail mounting
---------------	-------------------

Notes

Notes on operation	For proper use, the specifications of the installation directive (see Downloads) must be observed. For applications or use with third-party products, the specifications, and the safety and warning instructions of the respective third-party manufacturer must also be met.
--------------------	--------------------------------------------------------------------------------------------------------------------------------------------------------------------------------------------------------------------------------------------------------------------------------

UM-FLK10-5RSC-24DC/DO/ROC800 - Active module



2905960

<https://www.phoenixcontact.com/us/products/2905960>

Drawings

Dimensional drawing

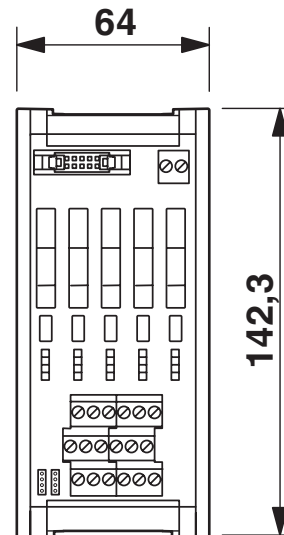
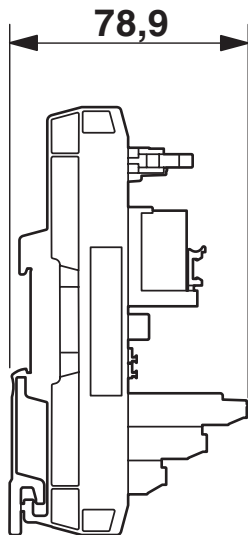

Circuit diagram

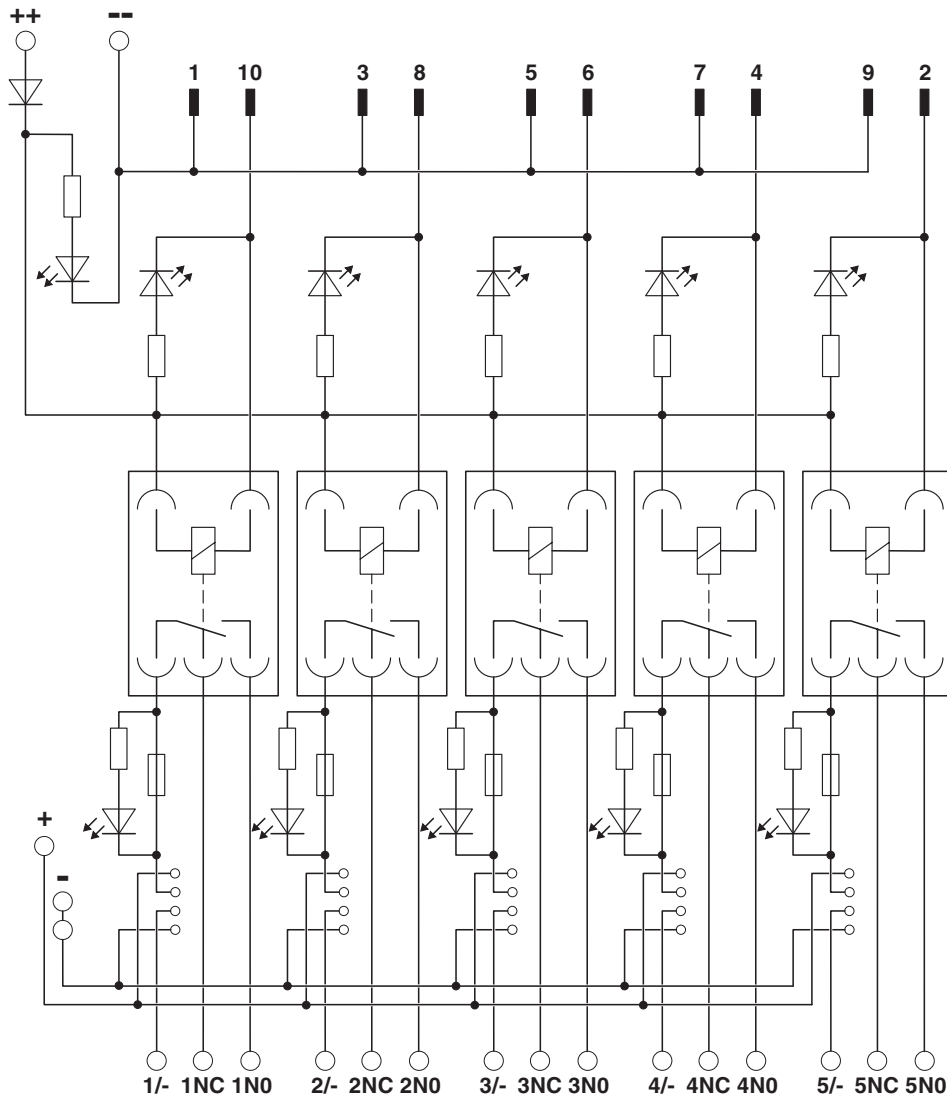



2905960

<https://www.phoenixcontact.com/us/products/2905960>

Approvals

To download certificates, visit the product detail page: <https://www.phoenixcontact.com/us/products/2905960>

 cUL Recognized Approval ID: E238705				
	Nominal voltage U_N	Nominal current I_N	Cross section AWG	Cross section mm^2
keine				
Coil side	-	-	30 - 12	-
Contact side	125 V	2 A	30 - 12	-

 UL Recognized Approval ID: E238705				
	Nominal voltage U_N	Nominal current I_N	Cross section AWG	Cross section mm^2
keine				
Coil side	-	-	30 - 12	-
Contact side	125 V	2 A	30 - 12	-

 cUL Recognized Approval ID: FILE E 196811				

 UL Recognized Approval ID: FILE E 196811				

UM-FLK10-5RSC-24DC/DO/ROC800 - Active module



2905960

<https://www.phoenixcontact.com/us/products/2905960>

Classifications

ECLASS

ECLASS-13.0	27141152
ECLASS-15.0	27141152

ETIM

ETIM 10.0	EC002780
-----------	----------

UNSPSC

UNSPSC 21.0	39121400
-------------	----------

2905960

<https://www.phoenixcontact.com/us/products/2905960>

Environmental product compliance

EU RoHS

Fulfills EU RoHS substance requirements	Yes
Exemption	6(c), 7(a), 7(c)-I

China RoHS

Environment friendly use period (EFUP)	EFUP-50
	An article-related China RoHS declaration table can be found in the download area for the respective article under "Manufacturer declaration". For all articles with EFUP-E, no China RoHS declaration table issued and required.

EU REACH SVHC

REACH candidate substance (CAS No.)	Lead(CAS: 7439-92-1)
SCIP	157c5c51-6dac-40bc-aa7c-3b964262f2cb

Phoenix Contact 2026 © - all rights reserved

<https://www.phoenixcontact.com>

Phoenix Contact USA
586 Fulling Mill Road
Middletown, PA 17057, United States
(+717) 944-1300
info@phoenixcon.com