

CB E1 24DC/1A SI-R P - Electronic circuit breaker



2905799

<https://www.phoenixcontact.com/us/products/2905799>

Please be informed that the data shown in this PDF document is generated from our online catalog. Please find the complete data in the user documentation. Our general terms of use for downloads are valid.



Electronic circuit breaker, 1-pos., active current limitation, inverted status output and control input, plug for base element.

Commercial data

Item number	2905799
Packing unit	1 pc
Note	Made to order (non-returnable)
Sales key	CL04
Product key	CLA134
GTIN	4046356997522
Weight per piece (including packing)	34.9 g
Weight per piece (excluding packing)	34.9 g
Customs tariff number	85362010
Country of origin	DE

Technical data

Product properties

Product type	Device circuit breakers
Product family	CB E
Type	Male
Number of positions	1

Insulation characteristics

Degree of pollution	2
---------------------	---

Electrical properties

Maximum current with single arrangement	1 A
---	-----

General

Operating voltage	24 V DC
	18 V DC ... 30 V DC
Nominal current I_N	1 A
Rated insulation voltage U_i	30 V (Load circuit)
Rated surge voltage	0.5 kV
Tripping method	E (electronic)
Required backup fuse	not required, integrated failsafe element
Dielectric strength	max. 30 V DC (Load circuit)
Active current limitation	typ. $1.25 \times I_N$
Fuse	electronic
Closed circuit current I_0	typ. 8 mA (When switched on)
	typ. 11 mA (With status output)
Power dissipation	0.4 W (Nominal operation)
Temperature derating	1 A (at 50 °C)
Voltage drop	140 mV (at I_N)
Fail-safe element	2 A DC
Contact switching type	without electrical isolation

Load circuit

Shutdown time	800 ms (see time/current characteristic curve)
Undervoltage switch-off	< 14 V (typ. OFF)
	> 17 V (typ. ON)
Max. capacitive load	20000 μ F
Switch-on delay	typ. 2 ms

Auxiliary contact

Contact connection type	Positive-switching signal output
-------------------------	----------------------------------

Reset

Input voltage range	7 V DC ... 30 V DC (Reset with falling edge)
---------------------	--

CB E1 24DC/1A SI-R P - Electronic circuit breaker



2905799

<https://www.phoenixcontact.com/us/products/2905799>

Current consumption	typ. 2.6 mA (at 24 V DC)
Pulse length	min. 20 ms
Voltage	< 3 V DC (Low state)
	> 8 V DC (High state)

Status output

Output voltage	24 V DC
Output current	max. 0.2 A (Short-circuit-proof)

Connection data

Connection method	pluggable
-------------------	-----------

Dimensions

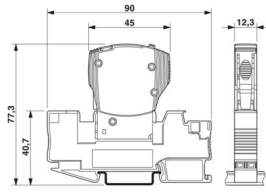
Dimensional drawing	
Width	12.3 mm
Height	45 mm
Depth	52 mm
Complete module width	12.3 mm
Complete module height	90 mm
Complete module depth	77.3 mm

Material specifications

Flammability rating according to UL 94	V-0
--	-----

Environmental and real-life conditions

Ambient conditions

Degree of protection	IP30 (Actuation area)
Ambient temperature (operation)	-25 °C ... 50 °C (non-condensing)
Ambient temperature (storage/transport)	-40 °C ... 70 °C
Humidity test	96 h, 95 % RH, 40 °C
Vibration (operation)	3g (according to IEC 60068-2-6, Test Fc)

Approvals

UL approval

Identification	UL Listed UL 508
	UL Recognized UL 2367

Shipbuilding approval

Identification	DNV GL
----------------	--------

CB E1 24DC/1A SI-R P - Electronic circuit breaker



2905799

<https://www.phoenixcontact.com/us/products/2905799>

Standards and regulations

Standard designation	EMV
Standards/specifications	EN 61000-6-3
Note	Interference emission
Standard designation	EMV
Standards/specifications	EN 61000-6-2
Note	Noise immunity

Mounting

Mounting type	on base element
---------------	-----------------

CB E1 24DC/1A SI-R P - Electronic circuit breaker

2905799

<https://www.phoenixcontact.com/us/products/2905799>

Drawings



The figure shows the complete module consisting of a base element and connector



Diagram

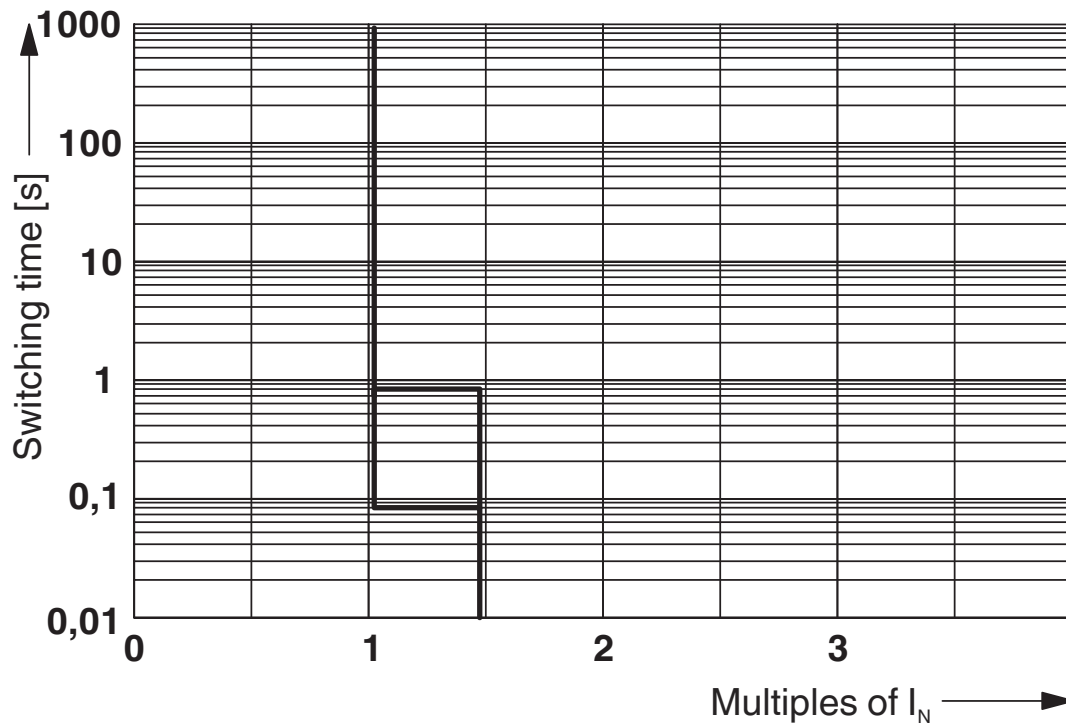

Trigger characteristic

Phoenix Contact 2026 © - all rights reserved
<https://www.phoenixcontact.com>

Phoenix Contact USA
586 Fulling Mill Road
Middletown, PA 17057, United States
(+717) 944-1300
info@phoenixcon.com