

# FLT-ISG-BR-62 - Fixing bracket

2905765

<https://www.phoenixcontact.com/us/products/2905765>

Please be informed that the data shown in this PDF document is generated from our online catalog. Please find the complete data in the user documentation. Our general terms of use for downloads are valid.

Bracket for fixing the FLT-ISG-100-EX isolating spark gap to a flange, drill hole diameter of 62 mm.



## Commercial data

Item number	2905765
Packing unit	1 pc
Minimum order quantity	1 pc
Note	Made to order (non-returnable)
Sales key	CL01
Product key	CL1134
GTIN	4055626002484
Weight per piece (including packing)	252.1 g
Weight per piece (excluding packing)	252.1 g
Customs tariff number	73269098
Country of origin	DE

# FLT-ISG-BR-62 - Fixing bracket

2905765

<https://www.phoenixcontact.com/us/products/2905765>



## Technical data

### Product properties

Product type	Mounting material
--------------	-------------------

### Material specifications

Color	zinc color
	gray (RAL 7042)
Material	St/tZn

### Mounting

Mounting type	Screw mounting
---------------	----------------

# FLT-ISG-BR-62 - Fixing bracket

2905765

<https://www.phoenixcontact.com/us/products/2905765>



## Drawings

Dimensional drawing

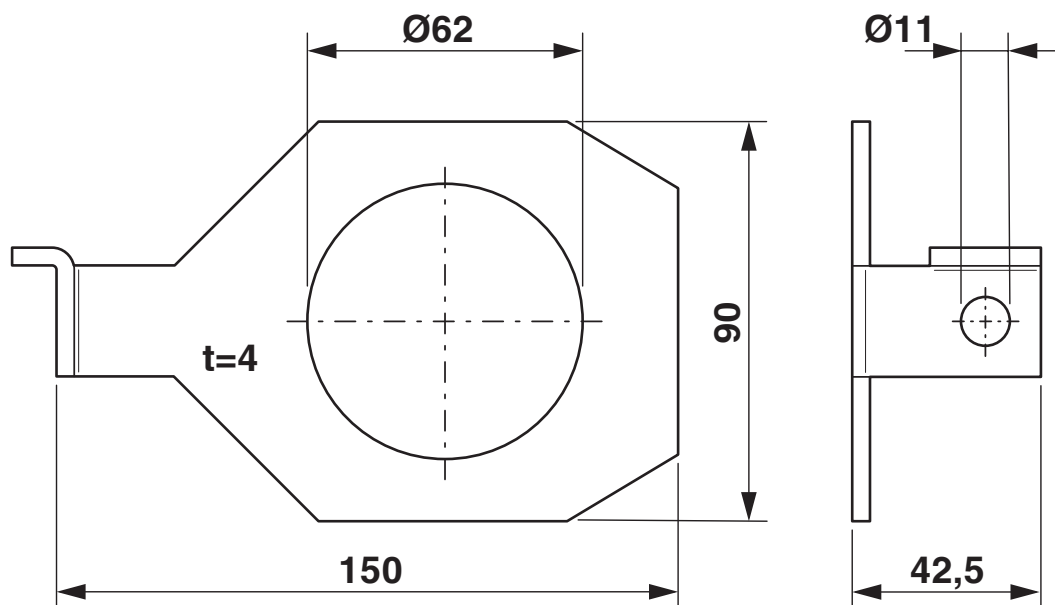

# FLT-ISG-BR-62 - Fixing bracket



2905765

<https://www.phoenixcontact.com/us/products/2905765>

## Classifications

### ECLASS

ECLASS-13.0	27170692
ECLASS-15.0	27170692

### ETIM

ETIM 10.0	EC000490
-----------	----------

### UNSPSC

UNSPSC 21.0	39121700
-------------	----------

# FLT-ISG-BR-62 - Fixing bracket



2905765

<https://www.phoenixcontact.com/us/products/2905765>

## Environmental product compliance

### EU RoHS

Fulfills EU RoHS substance requirements	Yes, No exemptions
---	--------------------

### China RoHS

Environment friendly use period (EFUP)	EFUP-E
	No hazardous substances above the limits

### EU REACH SVHC

REACH candidate substance (CAS No.)	No substance above 0.1 wt%
-------------------------------------	----------------------------

Phoenix Contact 2026 © - all rights reserved  
<https://www.phoenixcontact.com>

Phoenix Contact USA  
586 Fulling Mill Road  
Middletown, PA 17057, United States  
(+717) 944-1300  
[info@phoenixcon.com](mailto:info@phoenixcon.com)