

FLT-ISG-BR-22 - Fixing bracket

2905583

<https://www.phoenixcontact.com/us/products/2905583>

Please be informed that the data shown in this PDF document is generated from our online catalog. Please find the complete data in the user documentation. Our general terms of use for downloads are valid.

Bracket for fixing the FLT-ISG-100-EX isolating spark gap to a flange, drill hole diameter of 22 mm.



Commercial data

Item number	2905583
Packing unit	1 pc
Minimum order quantity	1 pc
Sales key	CL01
Product key	CL1134
GTIN	4055626002286
Weight per piece (including packing)	98.8 g
Weight per piece (excluding packing)	101.4 g
Customs tariff number	73269098
Country of origin	DE

FLT-ISG-BR-22 - Fixing bracket

2905583

<https://www.phoenixcontact.com/us/products/2905583>



Technical data

Product properties

Product type	Mounting material
--------------	-------------------

Material specifications

Color	zinc color
	gray (RAL 7042)
Material	St/tZn

Mounting

Mounting type	Screw mounting
---------------	----------------

FLT-ISG-BR-22 - Fixing bracket

2905583

<https://www.phoenixcontact.com/us/products/2905583>



Drawings

Dimensional drawing

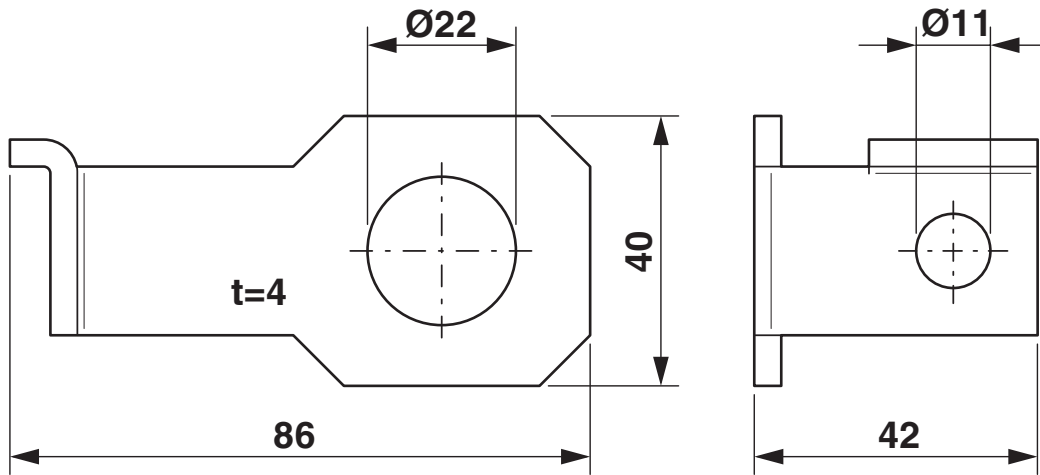

FLT-ISG-BR-22 - Fixing bracket



2905583

<https://www.phoenixcontact.com/us/products/2905583>

Classifications

ECLASS

ECLASS-13.0	27170692
ECLASS-15.0	27170692

ETIM

ETIM 10.0	EC000490
-----------	----------

UNSPSC

UNSPSC 21.0	39121700
-------------	----------

FLT-ISG-BR-22 - Fixing bracket



2905583

<https://www.phoenixcontact.com/us/products/2905583>

Environmental product compliance

EU RoHS

Fulfills EU RoHS substance requirements	Yes, No exemptions
---	--------------------

China RoHS

Environment friendly use period (EFUP)	EFUP-E
	No hazardous substances above the limits

EU REACH SVHC

REACH candidate substance (CAS No.)	No substance above 0.1 wt%
-------------------------------------	----------------------------

EF3.1 Climate Change

CO2e kg	1.027 kg CO2e
---------	---------------

Phoenix Contact 2026 © - all rights reserved
<https://www.phoenixcontact.com>

Phoenix Contact USA
586 Fulling Mill Road
Middletown, PA 17057, United States
(+717) 944-1300
info@phoenixcon.com