

# REL-OR2/LDP- 24DC/2X21 - Single relay



2903689

<https://www.phoenixcontact.com/us/products/2903689>

Please be informed that the data shown in this PDF document is generated from our online catalog. Please find the complete data in the user documentation. Our general terms of use for downloads are valid.



Plug-in octal relays with power contacts, 2 changeover contacts, test button, freewheeling diode, mechanical switching position indicator, polarity: A1+, A2-, coil voltage: 24 V DC

## Commercial data

Item number	2903689
Packing unit	1 pc
Note	Made to order (non-returnable)
Sales key	C460
Product key	DK6193
GTIN	4046356759021
Weight per piece (including packing)	86.41 g
Weight per piece (excluding packing)	86.41 g
Customs tariff number	85364190
Country of origin	PL

# REL-OR2/LDP- 24DC/2X21 - Single relay



2903689

<https://www.phoenixcontact.com/us/products/2903689>

## Technical data

### Product properties

Product type	Single relay
Set comprises	2903297 RIF-3-RPT-LDP-24DC/2X21
	2903303 RIF-3-RSC-LDP-24DC/2X21
Operating mode	100% operating factor
Mechanical service life	approx. $2 \times 10^7$ cycles

### Insulation characteristics

Insulation	Basic insulation
Overvoltage category	III
Pollution degree	3

### Data management status

Date of last data management	01.04.2026
------------------------------	------------

### Electrical properties

Maximum power dissipation for nominal condition	1.44 W
Test voltage (Winding/contact)	2.5 kV <sub>rms</sub> (50 Hz, 1 min., winding/contact)
Test voltage (Contact/contact)	2 kV <sub>rms</sub> (50 Hz, 1 min., contact/contact)
Test voltage (Changeover contact/changeover contact)	2 kV <sub>rms</sub> (50 Hz, 1 min., changeover contact/changeover contact)
Rated insulation voltage	250 V AC
Rated surge voltage	4 kV

### Input data

#### Coil side

Nominal input voltage $U_N$	24 V DC
Input voltage range	20.4 V DC ... 26.4 V DC (20 °C)
Drive and function	monostable
Typical input current at $U_N$	60 mA
Typical response time	18 ms
Typical release time	20 ms
Protective circuit	Freewheeling diode
Status display	LED (yellow)

### Output data

#### Switching

Contact switching type	2 changeover contacts
Type of switch contact	Single contact
Contact material	AgNi
Maximum switching voltage	250 V AC/DC
Minimum switching voltage	10 V (At 24 mA)

# REL-OR2/LDP- 24DC/2X21 - Single relay



2903689

<https://www.phoenixcontact.com/us/products/2903689>

Limiting continuous current	10 A
Maximum inrush current	30 A (20 ms, N/O contacts)
Min. switching current	10 mA (at 24 V)
Interrupting rating (ohmic load) max.	240 W (at 24 V DC)
	124 W (at 48 V DC)
	108 W (at 60 V DC)
	52 W (at 110 V DC)
	48 W (at 220 V DC)
	2500 VA (for 250 V AC)
Switching power min.	0.24 W
Switching capacity	2 A (at 24 V, DC13)
	0.22 A (at 120 V, DC13)
	0.11 A (at 250 V, DC13)
	3 A (at 24 V, AC15)
	3 A (at 120 V, AC15)
	1.5 A (at 240 V, AC15)
Motor load according to UL 508	1/2 HP, 240 V AC (N/O contact)

## Connection data

Connection method	Plug-in connection
-------------------	--------------------

## Dimensions

Width	35 mm
Height	35 mm
Depth	54.4 mm

## Environmental and real-life conditions

### Ambient conditions

Degree of protection	RT I
Ambient temperature (operation)	-40 °C ... 70 °C
Ambient temperature (storage/transport)	-40 °C ... 85 °C

## Approvals

### Corrosive gas test

Identification	ISA-S71.04. G3 Harsh Group
	EN 60068-2-60

## Standards and regulations

Standards/regulations	IEC 60664
	IEC 61810

## Mounting

Mounting position	any
-------------------	-----

Drawings

Diagram



- ① DC coils
- ② AC coils

Operating voltage range

Diagram



- ① AC, ohmic load
- ② DC, ohmic load

Interrupting rating

Diagram

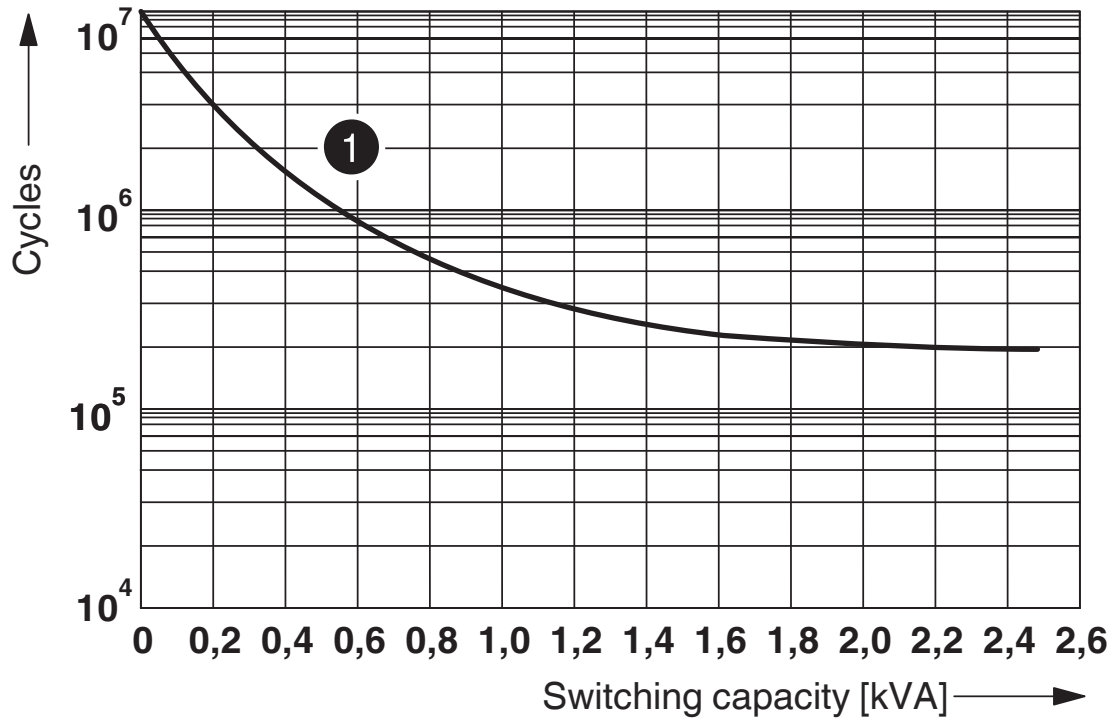

250 V AC, ohmic load

Electrical service life

Diagram

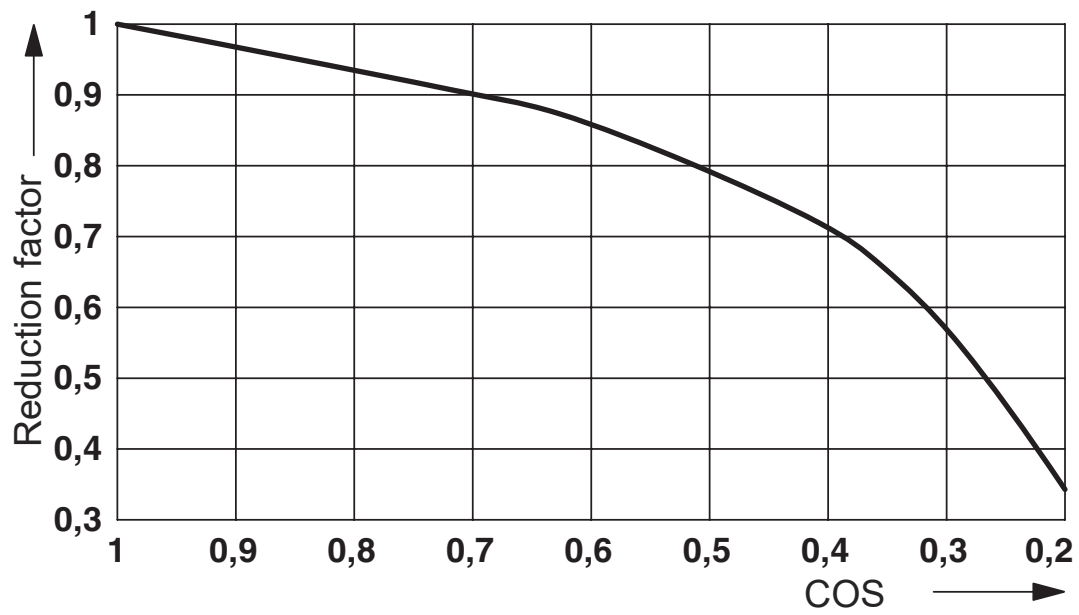

Service life reduction factor

Circuit diagram

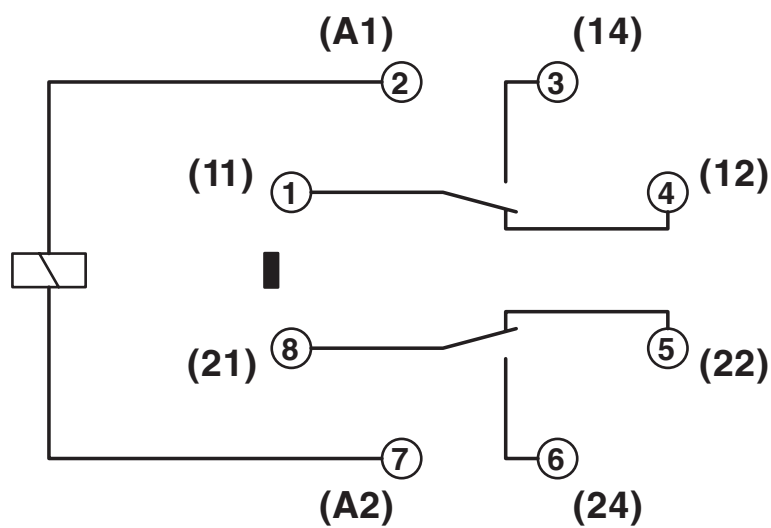

# REL-OR2/LDP- 24DC/2X21 - Single relay



2903689

<https://www.phoenixcontact.com/us/products/2903689>

## Classifications

### UNSPSC

UNSPSC 21.0	39122300
-------------	----------

# REL-OR2/LDP- 24DC/2X21 - Single relay



2903689

<https://www.phoenixcontact.com/us/products/2903689>

## Environmental product compliance

### EU RoHS

Fulfills EU RoHS substance requirements	Yes, No exemptions
---	--------------------

### China RoHS

Environment friendly use period (EFUP)	EFUP-E
	No hazardous substances above the limits

### EU REACH SVHC

REACH candidate substance (CAS No.)	No substance above 0.1 wt%
-------------------------------------	----------------------------

Phoenix Contact 2026 © - all rights reserved  
<https://www.phoenixcontact.com>

Phoenix Contact USA  
586 Fulling Mill Road  
Middletown, PA 17057, United States  
(+717) 944-1300  
[info@phoenixcon.com](mailto:info@phoenixcon.com)