

# RIF-2-RPT-LDP-24DC/4X21 - Relay module



2903308

<https://www.phoenixcontact.com/us/products/2903308>

Please be informed that the data shown in this PDF document is generated from our online catalog. Please find the complete data in the user documentation. Our general terms of use for downloads are valid.



Preassembled relay module with Push-in connection, consisting of: relay base, power contact relay, and retaining bracket. Contact switching type: 4 changeover contacts. Input voltage: 24 V DC

## Product description

The pluggable electromechanical and solid-state relays in the RIFLINE complete product range and the base are recognized and approved in accordance with UL 508. The relevant approvals can be called up at the individual components in question.

## Commercial data

Item number	2903308
Packing unit	10 pc
Minimum order quantity	10 pc
Sales key	C465
Product key	DK652A
GTIN	4046356732161
Weight per piece (including packing)	107.92 g
Weight per piece (excluding packing)	99.7 g
Customs tariff number	85364110
Country of origin	CN

# RIF-2-RPT-LDP-24DC/4X21 - Relay module



2903308

<https://www.phoenixcontact.com/us/products/2903308>

## Set consists of

### RIF-2-BPT/4X21 - Relay base

2900934

<https://www.phoenixcontact.com/us/products/2900934>



Relay base RIF-2..., for industrial relay with 2 or 4 changeover contacts, Push-in connection, plug-in option for input/interference suppression modules, for mounting on NS 35/7,5

---

### REL-IR4/LDP- 24DC/4X21 - Single relay

2903677

<https://www.phoenixcontact.com/us/products/2903677>



Plug-in industrial relay with power contacts, 4 changeover contacts, test button, status LED, freewheeling diode, mechanical switching position indicator, polarity: A1+, A2-, input voltage: 24 V DC

# RIF-2-RPT-LDP-24DC/4X21 - Relay module



2903308

<https://www.phoenixcontact.com/us/products/2903308>

## RIF-RH-2 - Retaining bracket

2900954

<https://www.phoenixcontact.com/us/products/2900954>



Relay retaining bracket, with ejector function and holder for marking material, suitable for RIF-2 relay base, for industrial relay

## Technical data

### Product properties

Product type	Relay Module
Product family	RIFLINE complete
Application	Universal
Operating mode	100% operating factor
Mechanical service life	approx. $2 \times 10^7$ cycles

### Insulation characteristics

Insulation	Basic insulation
Overvoltage category	II
Pollution degree	2

### Data management status

Date of last data management	20.01.2026
------------------------------	------------

### Electrical properties

Maximum power dissipation for nominal condition	1.01 W
Test voltage (Winding/contact)	2.5 kV <sub>rms</sub> (50 Hz, 1 min., winding/contact)
Test voltage (Contact/contact)	2 kV <sub>rms</sub> (50 Hz, 1 min., contact/contact)
Rated insulation voltage	250 V AC
Rated surge voltage	2.5 kV

### Input data

#### Coil side

Nominal input voltage $U_N$	24 V DC
Input voltage range	19.2 V DC ... 30 V DC (20 °C)
Input voltage range in reference to $U_N$	see diagram
Drive and function	monostable
Drive (polarity)	polarized
Typical input current at $U_N$	42 mA
Typical response time	13 ms
Typical release time	14 ms
Coil voltage	24 V DC
Protective circuit	Freewheeling diode
Operating voltage display	Yellow LED

### Output data

#### Switching

Contact switching type	4 changeover contacts
Type of switch contact	Single contact
Contact material	AgNi

# RIF-2-RPT-LDP-24DC/4X21 - Relay module



2903308

<https://www.phoenixcontact.com/us/products/2903308>

Maximum switching voltage	250 V AC/DC
Minimum switching voltage	5 V (At 24 mA)
Limiting continuous current	6 A (see diagram)
Maximum inrush current	16 A (20 ms, N/O contacts)
Min. switching current	5 mA (24 V)
Interrupting rating (ohmic load) max.	144 W (at 24 V DC)
	124 W (at 48 V DC)
	108 W (at 60 V DC)
	52 W (at 110 V DC)
	48 W (at 220 V DC)
	1500 VA (for 250 V AC)
Switching capacity	2 A (at 24 V, DC13)
	0.22 A (at 120 V, DC13)
	0.11 A (at 250 V, DC13)
	1.5 A (at 24 V, AC15)
	1.5 A (at 120 V, AC15)
	1 A (at 240 V, AC15)

## Connection data

Connection method	Push-in connection
Stripping length	8 mm
Conductor cross-section rigid	0.14 mm <sup>2</sup> ... 1.5 mm <sup>2</sup>
Conductor cross-section flexible	0.14 mm <sup>2</sup> ... 1.5 mm <sup>2</sup>
	0.14 mm <sup>2</sup> ... 1.5 mm <sup>2</sup> (Ferrule with plastic sleeve)
	0.14 mm <sup>2</sup> ... 1 mm <sup>2</sup> (Ferrule with plastic sleeve, two conductors on double terminal block)
Conductor cross-section AWG	26 ... 16 (solid)
	26 ... 16 (flexible)

## Dimensions

### Item dimensions

Width	31 mm
Height	96 mm
Depth	75 mm

### Drill hole

Diameter	3.2 mm
----------	--------

## Material specifications

Color	gray (RAL 7042)
Flammability rating according to UL 94 (Housing)	V2 (Housing)

## Environmental and real-life conditions

### Ambient conditions

# RIF-2-RPT-LDP-24DC/4X21 - Relay module



2903308

<https://www.phoenixcontact.com/us/products/2903308>

Degree of protection (Relay base)	IP20 (Relay base)
Degree of protection (Relay)	RT I (Relay)
Ambient temperature (operation)	-40 °C ... 60 °C
Ambient temperature (storage/transport)	-40 °C ... 85 °C

## Approvals

### Corrosive gas test

Identification	ISA-S71.04. G3 Harsh Group
	EN 60068-2-60

## Standards and regulations

Standards/regulations	IEC 60947-5-1
-----------------------	---------------

## Mounting

Mounting type	DIN rail mounting
Assembly note	in rows with zero spacing
Mounting position	any

## Drawings

Diagram



① DC coil (observe contact derating)

② AC coil (observe contact derating)

Operating voltage range

Diagram



- ① AC, ohmic load
- ② DC, ohmic load

Interrupting rating

Diagram



Contact derating

Diagram

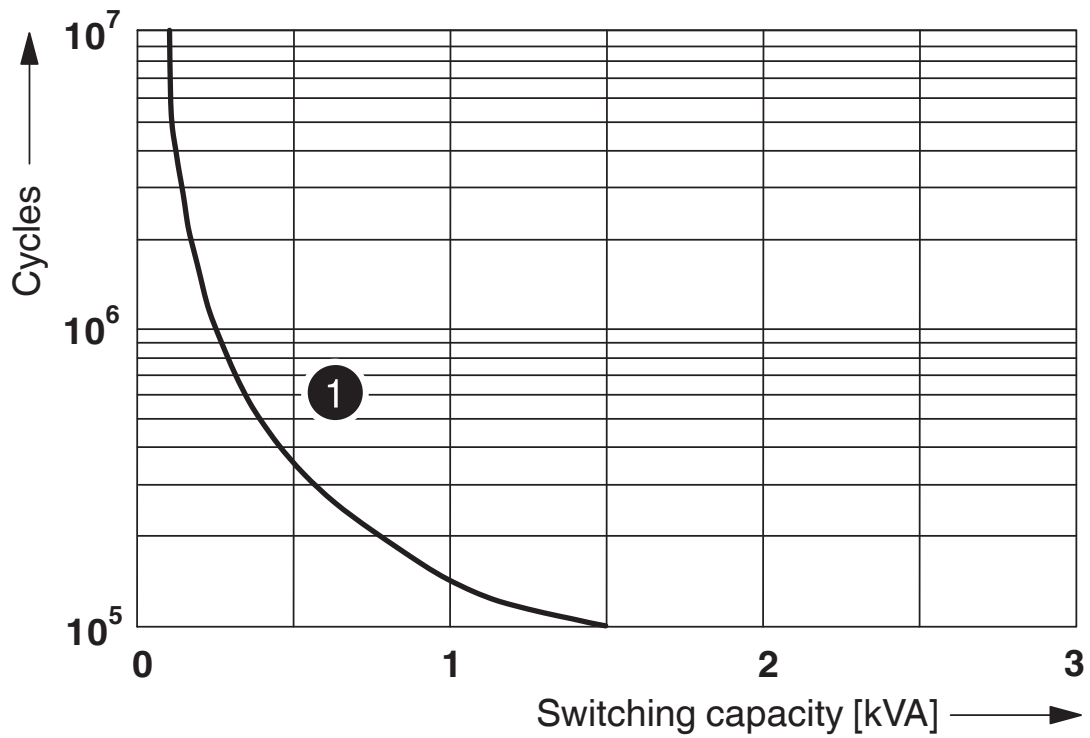

① 250 V AC, Ohmic load

Electrical service life

Diagram



Service life reduction factor



Permissible humidity for operation and storage.

The maximum permissible ambient temperature as specified in the data sheet must be observed.

Area A: Ice buildup at ambient temperatures  $\leq 0^\circ\text{C}$  must be prevented

Area B: Condensation at ambient temperatures  $> 0^\circ\text{C}$  must be prevented

On 30 full days that are naturally distributed across an entire year, a humidity level of 95% is permissible at an ambient temperature  $\leq 25^\circ\text{C}$ .

# RIF-2-RPT-LDP-24DC/4X21 - Relay module



2903308

<https://www.phoenixcontact.com/us/products/2903308>

Circuit diagram

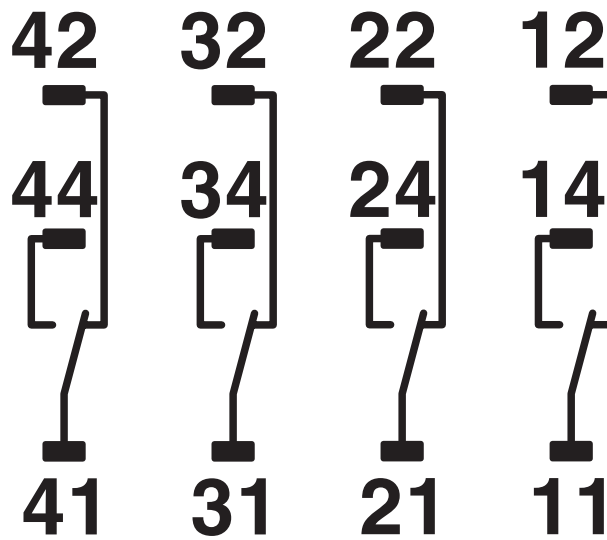

DC coils

# RIF-2-RPT-LDP-24DC/4X21 - Relay module



2903308

<https://www.phoenixcontact.com/us/products/2903308>

## Approvals

To download certificates, visit the product detail page: <https://www.phoenixcontact.com/us/products/2903308>



**CSA**

Approval ID: 76787

**DNV**

Approval ID: TAA000018V

# RIF-2-RPT-LDP-24DC/4X21 - Relay module



2903308

<https://www.phoenixcontact.com/us/products/2903308>

## Classifications

### ECLASS

ECLASS-13.0	27371601
ECLASS-15.0	27371601

### ETIM

ETIM 10.0	EC001437
-----------	----------

### UNSPSC

UNSPSC 21.0	39122300
-------------	----------

# RIF-2-RPT-LDP-24DC/4X21 - Relay module



2903308

<https://www.phoenixcontact.com/us/products/2903308>

## Environmental product compliance

### EU RoHS

Fulfills EU RoHS substance requirements	Yes, No exemptions
---	--------------------

### China RoHS

Environment friendly use period (EFUP)	EFUP-E
	No hazardous substances above the limits

### EU REACH SVHC

REACH candidate substance (CAS No.)	No substance above 0.1 wt%
-------------------------------------	----------------------------

Phoenix Contact 2026 © - all rights reserved

<https://www.phoenixcontact.com>

Phoenix Contact USA  
586 Fulling Mill Road  
Middletown, PA 17057, United States  
(+717) 944-1300  
[info@phoenixcon.com](mailto:info@phoenixcon.com)