

DFLK-D15 SUB/F/FKCT - Termination board



2903065

<https://www.phoenixcontact.com/us/products/2903065>

Please be informed that the data shown in this PDF document is generated from our online catalog. Please find the complete data in the user documentation. Our general terms of use for downloads are valid.



The VARIOFACE feed-through module implements a 1:1 connection between plug-in push-in spring-cage connection terminal blocks and a D-SUB miniature female strip (number of positions: 15). A separate ground pick-off is available.

Commercial data

Item number	2903065
Packing unit	1 pc
Minimum order quantity	1 pc
Note	Made to order (non-returnable)
Sales key	C422
Product key	DK21C2
GTIN	4046356709453
Weight per piece (including packing)	75.3 g
Weight per piece (excluding packing)	77.66 g
Customs tariff number	85366990
Country of origin	DE

DFLK-D15 SUB/F/FKCT - Termination board



2903065

<https://www.phoenixcontact.com/us/products/2903065>

Technical data

Product properties

Product type	Interface module
Product family	VARIOFACE
Number of positions	15

Insulation characteristics: Air clearances and creepage distances

Insulation	Functional insulation
Overvoltage category	II
Pollution degree	2

Electrical properties

Operating voltage (AC)	≤ 30 V AC
Operating voltage (DC)	≤ 60 V DC
Current (per branch)	≤ 2.5 A
Current (Total current)	≤ 37.5 A (50 °C)

Air clearances and creepage distances

Rated insulation voltage	125 V
Rated surge voltage	1.2 kV (1.2/50 μs)

Connection data

Connection 1 (control level)

Connection in acc. with standard	IEC 60807-2
Connection method	D-SUB socket strip
Screw thread	UNC 4-40
Number of connections	1
Number of positions	15
Insertion/withdrawal cycles	> 500
Pitch	2.74 mm

Connection 2 (field level)

Connection method	Push-in spring connection
Stripping length	10 mm
Number of positions	16
Conductor cross-section rigid	0.2 mm ² ... 2.5 mm ²
Conductor cross-section flexible	0.2 mm ² ... 2.5 mm ²
	0.25 mm ² ... 2.5 mm ² (Ferrule without plastic sleeve)
	0.25 mm ² ... 2.5 mm ² (Ferrule with plastic sleeve)
Conductor cross-section flexible (2 conductors with same cross section)	0.5 mm ² ... 1.5 mm ² (TWIN ferrule with plastic sleeve)
Conductor cross-section AWG	24 ... 12
Pitch	5 mm

DFLK-D15 SUB/F/FKCT - Termination board



2903065

<https://www.phoenixcontact.com/us/products/2903065>

Signaling

Status display present	no
------------------------	----

Dimensions

Item dimensions

Width	38 mm
Height	58.4 mm
Depth	46 mm

Material specifications

Color	gray (RAL 7042)
Housing insulation material	Polyamide PA non-reinforced

Environmental and real-life conditions

Ambient conditions

Degree of protection (Module)	IP20
Degree of protection (Installation location)	≥ IP54
Ambient temperature (operation)	-20 °C ... 50 °C
Ambient temperature (storage/transport)	-20 °C ... 70 °C
Altitude	≤ 2000 m

Approvals

UKCA

Certificate	UKCA-compliant
-------------	----------------

Standards and regulations

Air clearances and creepage distances

Standards/regulations	EN IEC 60664-1
-----------------------	----------------

Mounting

Mounting type	Rear mounting
Mounting position	any

Notes

Notes on operation	For proper use, the specifications of the installation directive (see Downloads) must be observed. For applications or use with third-party products, the specifications, and the safety and warning instructions of the respective third-party manufacturer must also be met.
--------------------	--

DFLK-D15 SUB/F/FKCT - Termination board



2903065

<https://www.phoenixcontact.com/us/products/2903065>

Drawings

Dimensional drawing

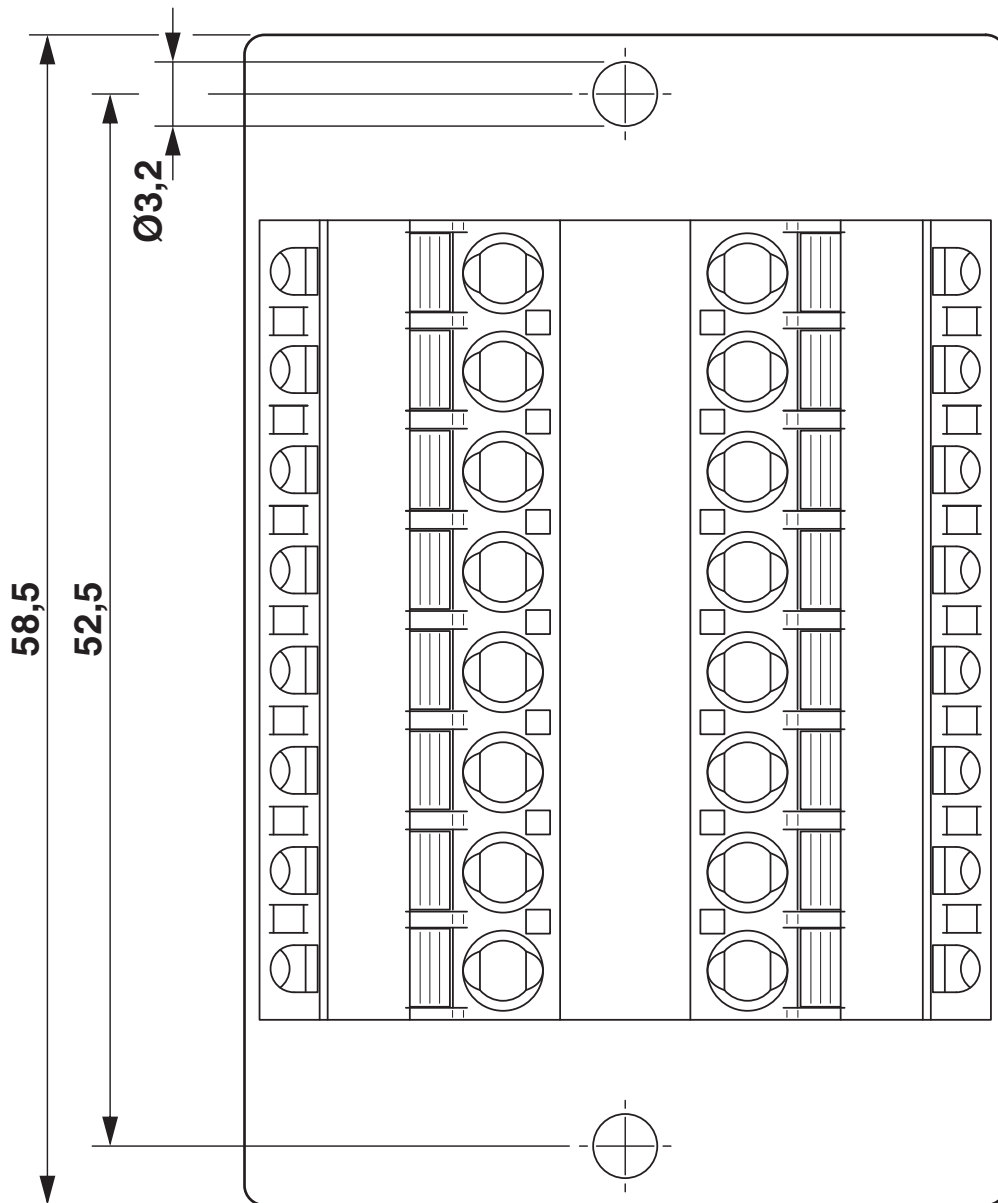

DFLK-D15 SUB/F/FKCT - Termination board

2903065

<https://www.phoenixcontact.com/us/products/2903065>

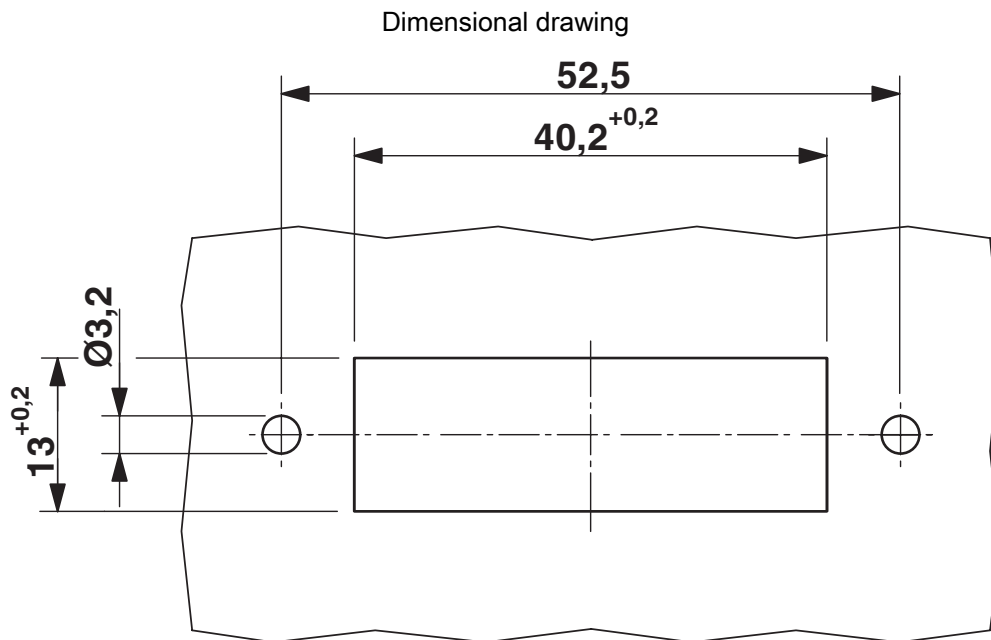

DFLK-D15 SUB/F/FKCT - Termination board



2903065

<https://www.phoenixcontact.com/us/products/2903065>

Approvals

To download certificates, visit the product detail page: <https://www.phoenixcontact.com/us/products/2903065>

 cUL Recognized Approval ID: E238705				
	Nominal voltage U_N	Nominal current I_N	Cross section AWG	Cross section mm^2
keine				
	125 V	1 A	30 - 12	-

 UL Recognized Approval ID: E238705				
	Nominal voltage U_N	Nominal current I_N	Cross section AWG	Cross section mm^2
keine				
	125 V	1 A	30 - 12	-

DFLK-D15 SUB/F/FKCT - Termination board



2903065

<https://www.phoenixcontact.com/us/products/2903065>

Classifications

ECLASS

ECLASS-13.0	27141152
ECLASS-15.0	27141152

ETIM

ETIM 10.0	EC002780
-----------	----------

UNSPSC

UNSPSC 21.0	39121400
-------------	----------

DFLK-D15 SUB/F/FKCT - Termination board



2903065

<https://www.phoenixcontact.com/us/products/2903065>

Environmental product compliance

EU RoHS

Fulfills EU RoHS substance requirements	Yes, No exemptions
---	--------------------

China RoHS

Environment friendly use period (EFUP)	EFUP-E
	No hazardous substances above the limits

EU REACH SVHC

REACH candidate substance (CAS No.)	No substance above 0.1 wt%
-------------------------------------	----------------------------

Phoenix Contact 2026 © - all rights reserved

<https://www.phoenixcontact.com>

Phoenix Contact USA
586 Fulling Mill Road
Middletown, PA 17057, United States
(+717) 944-1300
info@phoenixcon.com