

# RAD-CONF-RF7 - Configuration memory



2902816

<https://www.phoenixcontact.com/us/products/2902816>

Please be informed that the data shown in this PDF document is generated from our online catalog. Please find the complete data in the user documentation. Our general terms of use for downloads are valid.



Radioline - configuration stick for easy and safe network addressing for the 2.4 GHz wireless module (RAD-2400-...), unique network ID, RF band 7

## Your advantages

- Easy, unique, and safe network addressing
- Parallel operation of multiple networks (using different RF bands)

## Commercial data

Item number	2902816
Packing unit	1 pc
Minimum order quantity	1 pc
Sales key	DN23
Product key	DNC61Z
GTIN	4046356682114
Weight per piece (including packing)	5.5 g
Weight per piece (excluding packing)	5.5 g
Customs tariff number	85235110
Country of origin	DE

# RAD-CONF-RF7 - Configuration memory



2902816

<https://www.phoenixcontact.com/us/products/2902816>

## Technical data

### Notes

Note on application

Note on application

Only for industrial use

### Product properties

Product type

Storage medium

### Material specifications

Color

black (RAL 9005)

# RAD-CONF-RF7 - Configuration memory

2902816

<https://www.phoenixcontact.com/us/products/2902816>

## Drawings

Schematic diagram

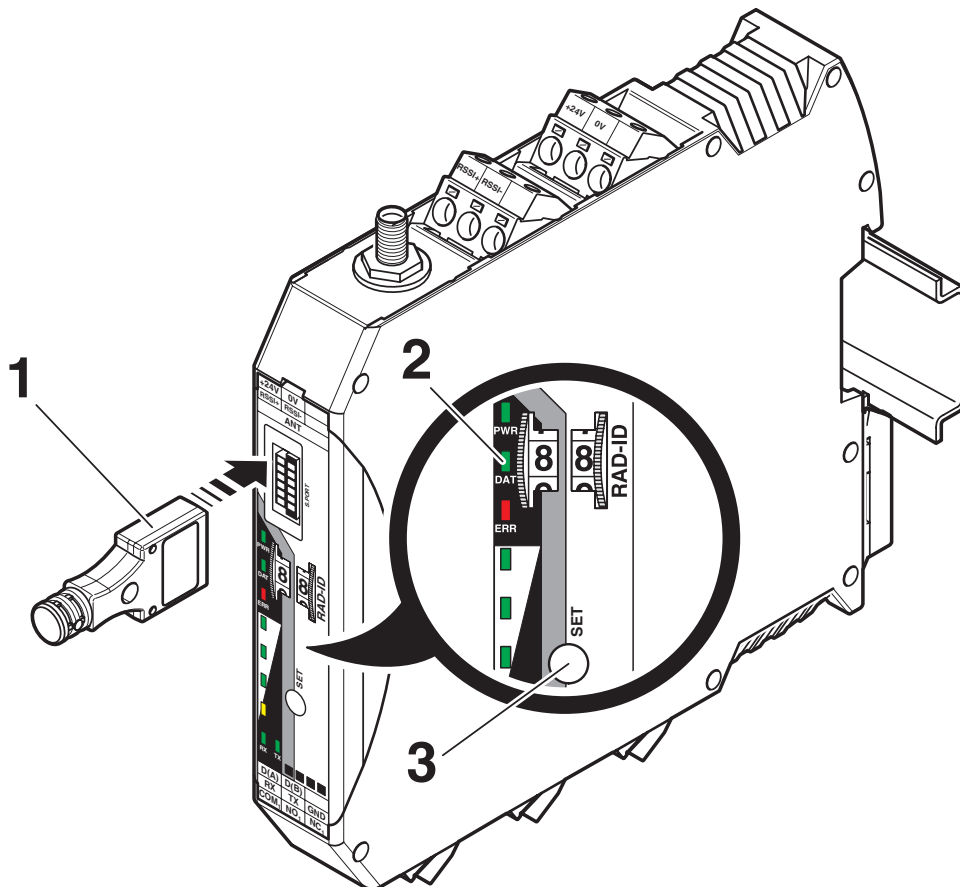

Configuration via CONFSTICK

# RAD-CONF-RF7 - Configuration memory



2902816

<https://www.phoenixcontact.com/us/products/2902816>

## Classifications

### ECLASS

ECLASS-13.0	27242212
ECLASS-15.0	27242212

### UNSPSC

UNSPSC 21.0	32101600
-------------	----------

# RAD-CONF-RF7 - Configuration memory



2902816

<https://www.phoenixcontact.com/us/products/2902816>

## Environmental product compliance

### EU RoHS

Fulfills EU RoHS substance requirements	Yes
Exemption	7(c)-I

### China RoHS

Environment friendly use period (EFUP)	EFUP-50
	An article-related China RoHS declaration table can be found in the download area for the respective article under "Manufacturer declaration". For all articles with EFUP-E, no China RoHS declaration table issued and required.

### EU REACH SVHC

REACH candidate substance (CAS No.)	No substance above 0.1 wt%
-------------------------------------	----------------------------

Phoenix Contact 2026 © - all rights reserved  
<https://www.phoenixcontact.com>

Phoenix Contact USA  
586 Fulling Mill Road  
Middletown, PA 17057, United States  
(+717) 944-1300  
[info@phoenixcon.com](mailto:info@phoenixcon.com)