

# FL SWITCH 3006T-2FX - Industrial Ethernet Switch



2891036

<https://www.phoenixcontact.com/us/products/2891036>

Please be informed that the data shown in this PDF document is generated from our online catalog. Please find the complete data in the user documentation. Our general terms of use for downloads are valid.



Managed Ethernet switch with six RJ45 ports at 10/100 Mbps, two SC format fiber optic ports and an operating temperature of -40°C ... +75°C

## Product description

FL SWITCH 3000 managed industrial Ethernet switches combine extensive network performance and security features with complete IEEE redundancy (STP/RSTP/MST) and 15 ms recovery time extended ring redundancy. Unique web customization provides a simplified user interface for today's applications and scalable functionality for future needs. A comprehensive mix of fiber optic and copper port connections meets a wide range of applications.

## Your advantages

- -40 to 75°C and -10 to 60°C ambient temperature versions
- RJ45 ports support a transmission speed of 10/100 Mbps
- Fiber-optic ports support 100 Mbps
- Secure web-based and SNMP-based management
- Extensive web diagnostics with configurable LED and remote alarm contacts
- Security options with cable locking
- Unique cleanup function hides unused configuration pages, reducing complexity, maintenance and startup times
- Auto negotiation and autocrossing detection simplifies installation and setup

## Commercial data

Item number	2891036
Packing unit	1 pc
Minimum order quantity	1 pc
Sales key	DN17
Product key	DNN125
GTIN	4046356659161
Weight per piece (including packing)	1,147.3 g
Weight per piece (excluding packing)	960 g
Customs tariff number	85176200
Country of origin	TW

## Technical data

### Dimensions

Dimensional drawing		
Width		54.4 mm
Height		146.4 mm
Depth		125 mm

### Notes

#### Note on application

Note on application	Only for industrial use
---------------------	-------------------------

#### Utilization restriction

CCCex note	Use in potentially explosive areas is not permitted in China.
------------	---

### Material specifications

Housing material	Aluminum
------------------	----------

### Mounting

Mounting type	DIN rail mounting
---------------	-------------------

### Interfaces

#### Ethernet (RJ45)

Connection method	RJ45
Note on the connection method	Auto negotiation and autocrossing
Transmission speed	10/100 Mbps
Transmission physics	Ethernet in RJ45 twisted pair
Transmission length	100 m
No. of channels	6 (RJ45 ports)

#### Fiber optic interface

Connection method	SC
Transmission speed	100 Mbps (full duplex)
Transmission physics	multi-mode fiberglass
Transmission length	12.1 km (fiberglass with F-G 62.5/125 0.7 dB/km F1000)
	3.3 km (fiberglass with F-G 62.5/125 2.6 dB/km F600)
	7.1 km (fiberglass with F-G 50/125 0.7 dB/km F1200)
	3.1 km (fiberglass with F-G 50/125 1.6 dB/km F800)

# FL SWITCH 3006T-2FX - Industrial Ethernet Switch



2891036

<https://www.phoenixcontact.com/us/products/2891036>

Wavelength	1300 nm
No. of channels	2 (SC multi-mode)

## Product properties

Product type	Switch
Product family	Managed Switch 3000
Type	Block design

## Insulation characteristics

Protection class	III (VDE 0106, IEC 60536)
------------------	---------------------------

## Switch functions

Basic functions	Store and forward switch, Extended Ring and IEEE redundancy, Multicast control, IGMP snooping, trunking, Port and Tagging VLANs, Port and IEEE 802.1x security, SNMP V3 and Https security, SNTP, web customization, user accounts
Signal contact control voltage	24 V DC
Signal contact control current	100 mA
Redundancy	ERR (Extended ring redundancy)
Status and diagnostic indicators	LEDs: U <sub>S1</sub> , U <sub>S2</sub> (redundant voltage supply), link and activity per port

## Security functions

Basic functions	Store and forward switch, Extended Ring and IEEE redundancy, Multicast control, IGMP snooping, trunking, Port and Tagging VLANs, Port and IEEE 802.1x security, SNMP V3 and Https security, SNTP, web customization, user accounts
-----------------	--

## Electrical properties

Local diagnostics	US1, US2 Supply voltage Green LED
	LNK/ACT Link status/data transmission Green LED
	100 Data transmission speed LED red
Maximum power dissipation for nominal condition	7.92 W
Test section	Supply voltage/functional ground 500 V 1 min
Transmission medium	Copper

## Supply

Supply voltage (DC)	24 V DC (redundant)
Supply voltage range	12 V DC ... 48 V DC
Inrush current	4.6 A (3.1 ms)
Residual ripple	3.6 V <sub>pp</sub> (within the permitted voltage range)
Typical current consumption	287 mA (at U <sub>S</sub> = 24 V DC)

## Function

Signal contact control voltage	24 V DC
Signal contact control current	100 mA

## Connection data

# FL SWITCH 3006T-2FX - Industrial Ethernet Switch



2891036

<https://www.phoenixcontact.com/us/products/2891036>

## Power supply

Connection method	Screw connection
pluggable	yes
Conductor cross-section, rigid	0.2 mm <sup>2</sup> ... 2.5 mm <sup>2</sup>
Conductor cross-section, flexible	0.2 mm <sup>2</sup> ... 2.5 mm <sup>2</sup>
Conductor cross-section AWG	24 ... 12
Stripping length	7 mm

## Environmental and real-life conditions

### Ambient conditions

Degree of protection	IP20
Ambient temperature (operation)	-40 °C ... 75 °C
Ambient temperature (storage/transport)	-40 °C ... 85 °C
Permissible humidity (operation)	5 % ... 95 % (non-condensing)
Permissible humidity (storage/transport)	5 % ... 95 % (non-condensing)
Air pressure (operation)	57 kPa ... 108 kPa (up to 4850 m above mean sea level)
Air pressure (storage/transport)	57 kPa ... 108 kPa (up to 4850 m above mean sea level)

## Approvals

### Conformity/Approvals

Conformance	CE-compliant
ATEX	⊕ II 3 G Ex nA nC IIC T4 Gc
EU-type examination certificate	DEMKO 16 ATEX 1616X
IECEX	Ex nA nC IIC T4 Gc
IECEX certificate	IECEX UL 16.0094X
UL, USA / Canada	Class I, Div. 2, Groups A, B, C, D

## EMC data

Conformance with EMC directives	IEC 61000-6-2 IEC 61000-4-2 (ESD) Criterion B
	IEC 61000-4-3 (immunity to radiated interference) Criterion A
	IEC 61000-4-4 (burst) Criterion A
	IEC 61000-4-5 (surge) Criterion B
	IEC 61000-4-6 (immunity to conducted interference) Criterion A
	IEC 61000-4-8 (immunity to magnetic fields) Criterion A
	EN 55022 (emitted interference) Class A
Noise immunity	NEMA TS-2
	EN 61000-6-2:2005

### Noise emission

Standards/regulations	EN 61000-6-4
-----------------------	--------------

## System properties

### Functionality

# FL SWITCH 3006T-2FX - Industrial Ethernet Switch



2891036

<https://www.phoenixcontact.com/us/products/2891036>

## Basic functions

Store and forward switch, Extended Ring and IEEE redundancy, Multicast control, IGMP snooping, trunking, Port and Tagging VLANs, Port and IEEE 802.1x security, SNMP V3 and Https security, SNTP, web customization, user accounts

## Signaling

### Status display

LEDs: U<sub>S1</sub>, U<sub>S2</sub> (redundant voltage supply), link and activity per port

# FL SWITCH 3006T-2FX - Industrial Ethernet Switch



2891036

<https://www.phoenixcontact.com/us/products/2891036>

## Drawings

Dimensional drawing

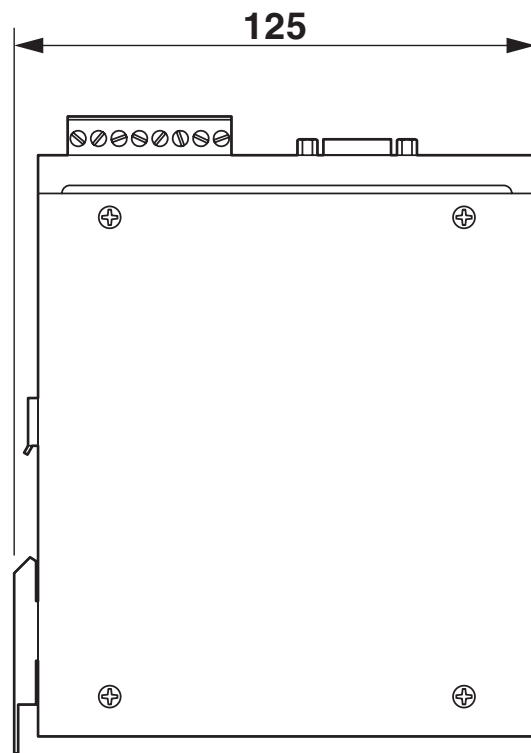
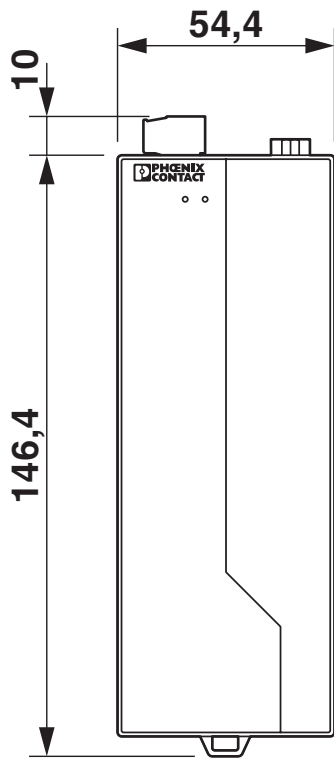

# FL SWITCH 3006T-2FX - Industrial Ethernet Switch



2891036

<https://www.phoenixcontact.com/us/products/2891036>

## Approvals

To download certificates, visit the product detail page: <https://www.phoenixcontact.com/us/products/2891036>

 **UL Listed**  
Approval ID: E140324

 **cUL Listed**  
Approval ID: E140324

 **KC**  
Approval ID: KCC-REI-PCK-FL289103

 **IECEx**  
Approval ID: IECEx UL 16.0094X

 **cUL Listed**  
Approval ID: File E 360692

 **UL Listed**  
Approval ID: File E 360692

 **UL Listed**  
Approval ID: E196811

 **cUL Listed**  
Approval ID: E196811

 **ATEX**  
Approval ID: DEMKO 16 ATEX 1616X

# FL SWITCH 3006T-2FX - Industrial Ethernet Switch



2891036

<https://www.phoenixcontact.com/us/products/2891036>

## Classifications

### ECLASS

ECLASS-13.0	19170401
ECLASS-15.0	19170401

### ETIM

ETIM 10.0	EC000734
-----------	----------

### UNSPSC

UNSPSC 21.0	43222600
-------------	----------

2891036

<https://www.phoenixcontact.com/us/products/2891036>

## Environmental product compliance

### EU RoHS

Fulfills EU RoHS substance requirements	Yes
Exemption	6(c), 7(a), 7(c)-I

### China RoHS

Environment friendly use period (EFUP)	EFUP-10
	An article-related China RoHS declaration table can be found in the download area for the respective article under "Manufacturer declaration". For all articles with EFUP-E, no China RoHS declaration table issued and required.

### EU REACH SVHC

REACH candidate substance (CAS No.)	Lead(CAS: 7439-92-1)
SCIP	fe809a90-3b9c-495d-be90-4e4b1facbaa8

Phoenix Contact 2026 © - all rights reserved

<https://www.phoenixcontact.com>

Phoenix Contact USA  
586 Fulling Mill Road  
Middletown, PA 17057, United States  
(+717) 944-1300  
[info@phoenixcon.com](mailto:info@phoenixcon.com)