

# PR1-RSC3-LV-230AC/2X21 - Relay module



2834517

<https://www.phoenixcontact.com/us/products/2834517>

Please be informed that the data shown in this PDF document is generated from our online catalog. Please find the complete data in the user documentation. Our general terms of use for downloads are valid.



Pre-assembled relay modules with screw connection, consisting of: relay base, plug-in miniature power relay with power contacts, plug-in display/interference suppression module, and relay retaining bracket. Input voltage: 230 V AC, contacts: 2 changeover contacts, 8 A

## Your advantages

- Safe isolation between coil and contact side
- Logical contact arrangement thanks to 1/3-level relay base
- Operational reliability thanks to sealed relay

## Commercial data

Item number	2834517
Packing unit	1 pc
Note	Made to order (non-returnable)
Sales key	C463
Product key	DK6319
GTIN	4046356044400
Weight per piece (including packing)	70.38 g
Weight per piece (excluding packing)	65.9 g
Customs tariff number	85364900
Country of origin	CN

# PR1-RSC3-LV-230AC/2X21 - Relay module

2834517

<https://www.phoenixcontact.com/us/products/2834517>

## Set consists of

### PR1-BSC3/2X21 - Relay base

2833521

<https://www.phoenixcontact.com/us/products/2833521>



PR1... relay base, for miniature power relays or miniature switching relays with 1 or 2 changeover contacts or solid-state relays of the same design, 1/3-level version, screw connections, plug-in option for input/interference suppression modules

---

### REL-MR-230AC/21-21 - Single relay

2961451

<https://www.phoenixcontact.com/us/products/2961451>

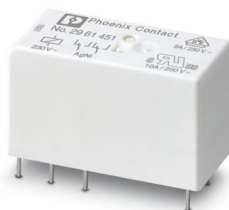

Plug-in miniature power relay, with power contact, 2 changeover contacts, input voltage 230 V AC

## PR1-RSC3-LV-230AC/2X21 - Relay module

2834517

<https://www.phoenixcontact.com/us/products/2834517>



### LV-120-230AC/110DC - Plug-in module

2833738

<https://www.phoenixcontact.com/us/products/2833738>



Plug-in module, with varistor and yellow LED, input voltage: 120 ... 230 V AC / 110 V DC  $\pm 20\%$

---

### EL1-P16 - Retaining bracket

2833547

<https://www.phoenixcontact.com/us/products/2833547>



Relay retaining bracket, with eject function and integrated equipment marking area (7.5 x 15 mm), to suit relay base PR1, for 16 mm high miniature power relay and solid-state relay

# PR1-RSC3-LV-230AC/2X21 - Relay module



2834517

<https://www.phoenixcontact.com/us/products/2834517>

## MP 1 - Marker labels

2833631

<https://www.phoenixcontact.com/us/products/2833631>

Equipment marker, labeling surface 6 x 15 mm



## Technical data

### Product properties

Product type	Relay Module
Application	Universal
Operating mode	100% operating factor
Mechanical service life	3x 10 <sup>7</sup> cycles

### Insulation characteristics

Overvoltage category	III
Pollution degree	3

### Data management status

Date of last data management	12.09.2025
------------------------------	------------

### Electrical properties

Service life electrical	see diagram
Maximum power dissipation for nominal condition	1.38 W
Test voltage (Winding/contact)	4 kV (50 Hz, 1 min., winding/contact)
Test voltage (Contact/contact)	2.5 kV (50 Hz, 1 min., contact/contact)

### Input data

#### Coil side

Nominal input voltage U <sub>N</sub>	230 V AC
Input voltage range	179.4 V AC ... 356.5 V AC
Drive and function	monostable
Typical input current at U <sub>N</sub>	6 mA (at 50 Hz) 5.5 mA (At 60 Hz)
Typical response time	3 ms ... 12 ms
Typical release time range	2 ms ... 22 ms
Protective circuit	Varistor
Operating voltage display	Yellow LED

### Output data

#### Switching

Contact switching type	2 changeover contacts
Type of switch contact	Single contact
Contact material	AgNi
Maximum switching voltage	250 V AC/DC
Minimum switching voltage	5 V (at 10 mA)
Limiting continuous current	8 A
Maximum inrush current	15 A (300 ms)
Min. switching current	10 mA (At 5 V)

# PR1-RSC3-LV-230AC/2X21 - Relay module



2834517

<https://www.phoenixcontact.com/us/products/2834517>

Interrupting rating (ohmic load) max.	2000 W (for 250 V AC)
	44 W (at 110 V DC)
	60 W (at 220 V DC)
	190 W (at 24 V DC)
	at 440 V AC
	85 W (at 48 V DC)
	60 W (at 60 V DC)
Switching capacity	2 A (at 24 V, DC13)
	0.2 A (at 250 V, DC13)
	3 A (at 24 V, AC15)
	3 A (at 120 V, AC15)
	3 A (at 250 V, AC15)

## Connection data

### Coil side

Connection method	Screw connection
Stripping length	8 mm
Screw thread	M3
Conductor cross-section rigid	0.14 mm <sup>2</sup> ... 2.5 mm <sup>2</sup>
Conductor cross-section flexible	0.14 mm <sup>2</sup> ... 2.5 mm <sup>2</sup>
Conductor cross-section AWG	26 ... 14

### Contact side

Connection method	Screw connection
Stripping length	8 mm
Screw thread	M3
Conductor cross-section rigid	0.14 mm <sup>2</sup> ... 2.5 mm <sup>2</sup>
Conductor cross-section flexible	0.14 mm <sup>2</sup> ... 2.5 mm <sup>2</sup>
Conductor cross-section AWG	26 ... 14

## Dimensions

Width	16 mm
Height	78.5 mm
Depth	71 mm

## Material specifications

Color	green (RAL 6021)
-------	------------------

## Environmental and real-life conditions

### Ambient conditions

Ambient temperature (operation)	-25 °C ... 60 °C
Ambient temperature (storage/transport)	-25 °C ... 85 °C

## Standards and regulations

# PR1-RSC3-LV-230AC/2X21 - Relay module



2834517

<https://www.phoenixcontact.com/us/products/2834517>

Standards/regulations	IEC 60664
	EN 50178

## Mounting

Mounting type	DIN rail mounting
Assembly note	in rows with zero spacing
Mounting position	any

Drawings

Diagram

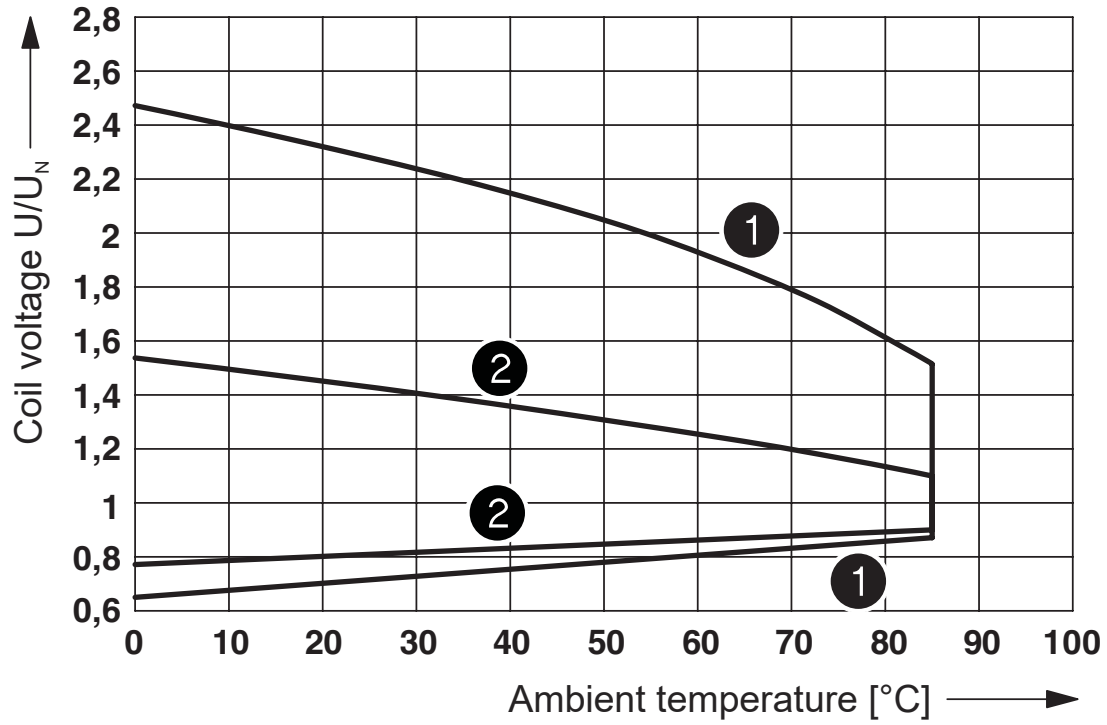

- ① DC coils
- ② AC coils

Operating voltage range of the relay

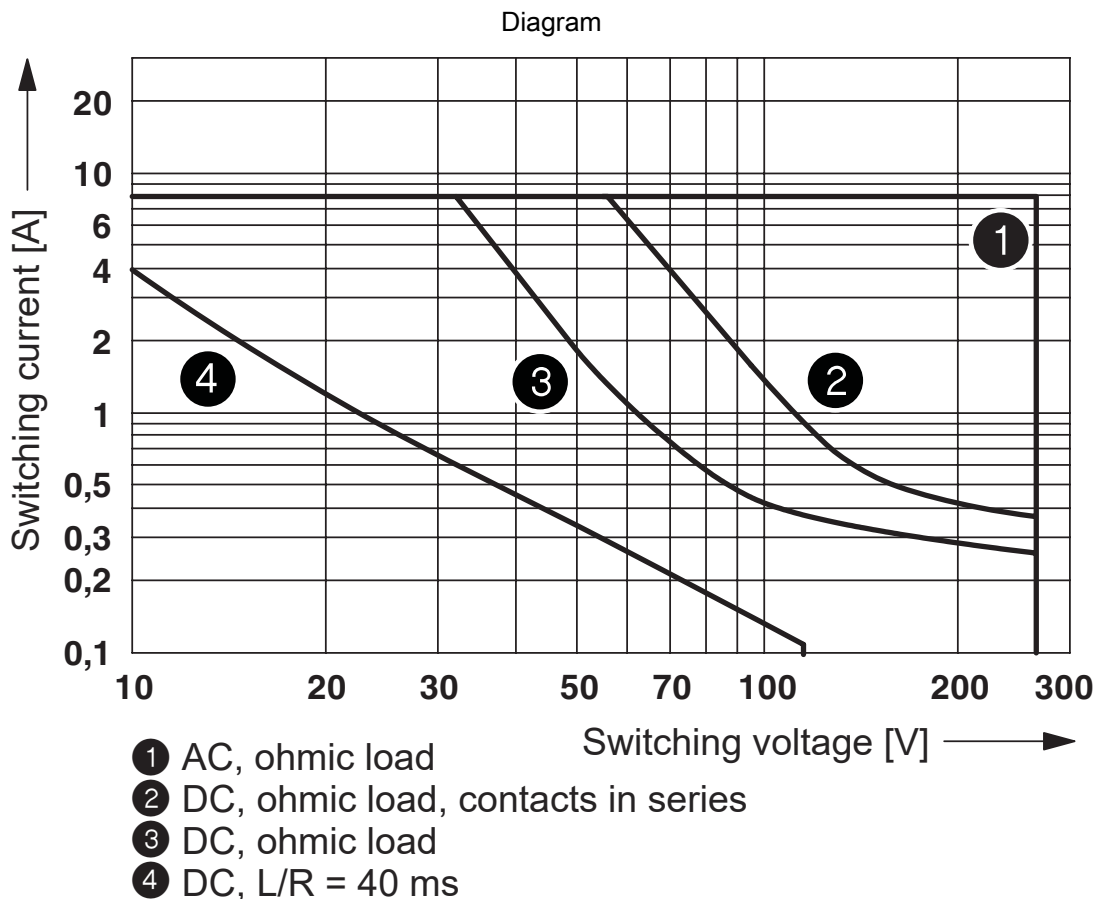

Interrupting rating

Diagram

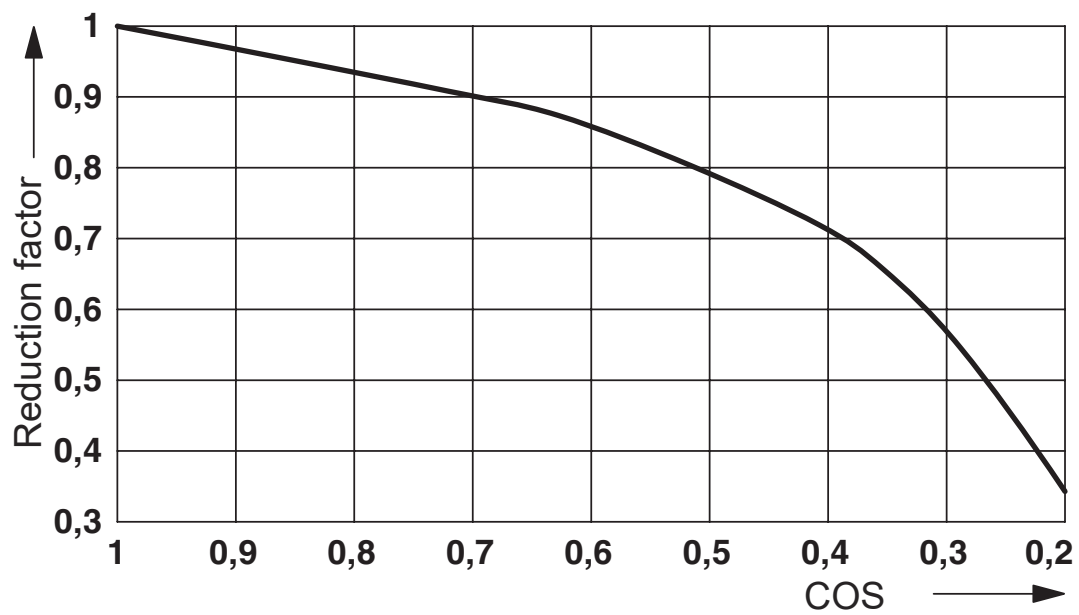

Service life reduction factor with various cos phi

Diagram

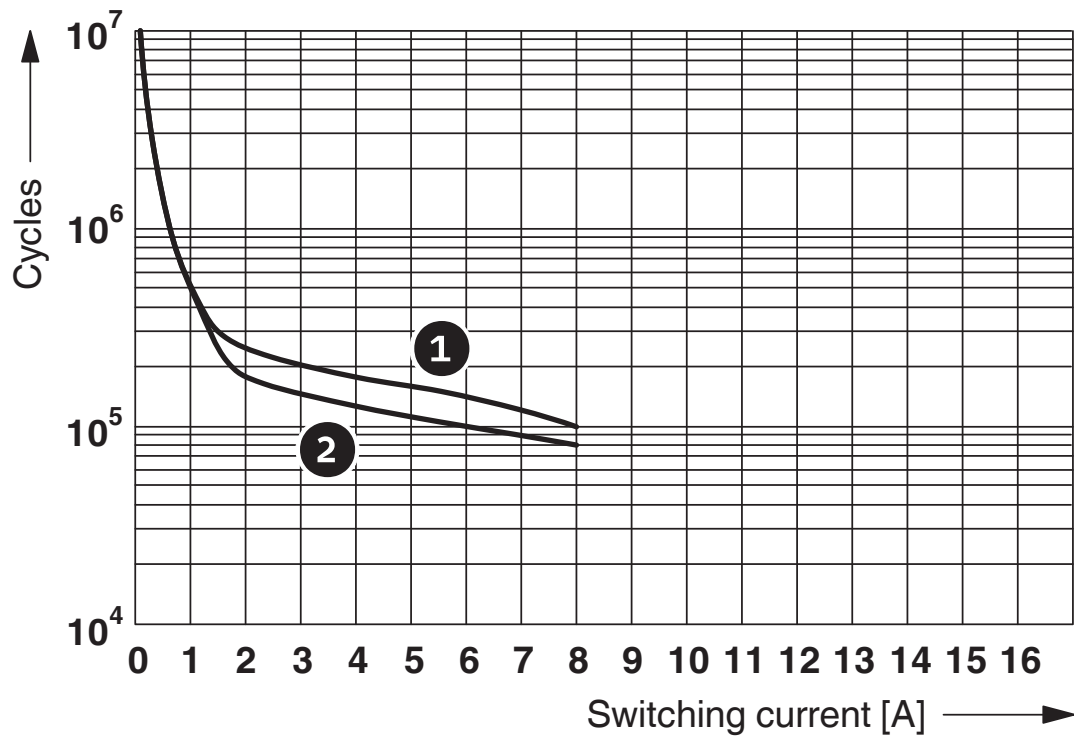

- ① 250 V AC, ohmic load (DC coils)
- ② 250 V AC, ohmic load (AC coils)

Electrical service life

# PR1-RSC3-LV-230AC/2X21 - Relay module

2834517

<https://www.phoenixcontact.com/us/products/2834517>



Circuit diagram

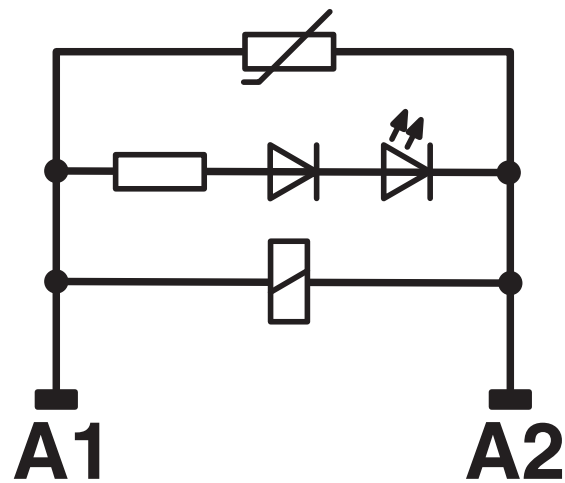
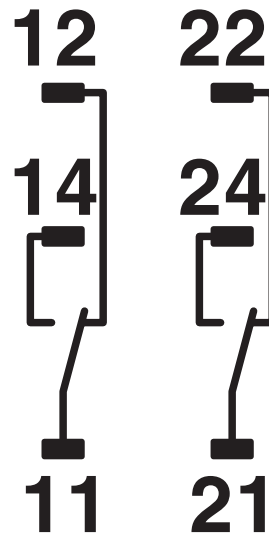

# PR1-RSC3-LV-230AC/2X21 - Relay module



2834517

<https://www.phoenixcontact.com/us/products/2834517>

## Classifications

### UNSPSC

UNSPSC 21.0	39122334
-------------	----------

# PR1-RSC3-LV-230AC/2X21 - Relay module



2834517

<https://www.phoenixcontact.com/us/products/2834517>

## Environmental product compliance

### EU RoHS

Fulfills EU RoHS substance requirements	Yes, No exemptions
---	--------------------

### China RoHS

Environment friendly use period (EFUP)	EFUP-E
	No hazardous substances above the limits

### EU REACH SVHC

REACH candidate substance (CAS No.)	No substance above 0.1 wt%
-------------------------------------	----------------------------

Phoenix Contact 2026 © - all rights reserved  
<https://www.phoenixcontact.com>

Phoenix Contact USA  
586 Fulling Mill Road  
Middletown, PA 17057, United States  
(+717) 944-1300  
[info@phoenixcon.com](mailto:info@phoenixcon.com)