

PR1-RSC3-LV- 24AC/2X21 - Relay module



2834494

<https://www.phoenixcontact.com/us/products/2834494>

Please be informed that the data shown in this PDF document is generated from our online catalog. Please find the complete data in the user documentation. Our general terms of use for downloads are valid.



Fully mounted relay modules with screw connection, consisting of: relay base, plug-in miniature power relay with power contacts, plug-in display/interference suppression module, and relay retaining bracket. Input voltage: 24 V AC, contacts: 2 changeover contacts, 8 A

Your advantages

- Safe isolation between coil and contact side
- Operational reliability thanks to sealed relay
- Logical contact arrangement thanks to 1/3-level relay base

Commercial data

Item number	2834494
Packing unit	1 pc
Note	Made to order (non-returnable)
Sales key	C463
Product key	DK6319
GTIN	4046356044387
Weight per piece (including packing)	70.35 g
Weight per piece (excluding packing)	68.26 g
Customs tariff number	85364900
Country of origin	CN

PR1-RSC3-LV- 24AC/2X21 - Relay module

2834494

<https://www.phoenixcontact.com/us/products/2834494>

Set consists of

PR1-BSC3/2X21 - Relay base

2833521

<https://www.phoenixcontact.com/us/products/2833521>



PR1... relay base, for miniature power relays or miniature switching relays with 1 or 2 changeover contacts or solid-state relays of the same design, 1/3-level version, screw connections, plug-in option for input/interference suppression modules

REL-MR- 24AC/21-21 - Single relay

2961435

<https://www.phoenixcontact.com/us/products/2961435>

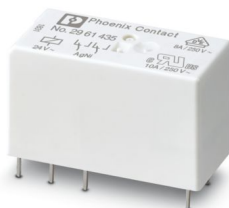

Plug-in miniature power relay, with power contact, 2 changeover contacts, input voltage 24 V AC

PR1-RSC3-LV- 24AC/2X21 - Relay module



2834494

<https://www.phoenixcontact.com/us/products/2834494>

LV- 12- 24UC - Plug-in module

2833712

<https://www.phoenixcontact.com/us/products/2833712>



Plug-in module, for mounting on PR1 and PR2, with varistor and yellow LED, input voltage: 12 ... 24 V AC/ DC ± 20 %

EL1-P16 - Retaining bracket

2833547

<https://www.phoenixcontact.com/us/products/2833547>



Relay retaining bracket, with eject function and integrated equipment marking area (7.5 x 15 mm), to suit relay base PR1, for 16 mm high miniature power relay and solid-state relay

PR1-RSC3-LV- 24AC/2X21 - Relay module

2834494

<https://www.phoenixcontact.com/us/products/2834494>



MP 1 - Marker labels

2833631

<https://www.phoenixcontact.com/us/products/2833631>

Equipment marker, labeling surface 6 x 15 mm



PR1-RSC3-LV- 24AC/2X21 - Relay module



2834494

<https://www.phoenixcontact.com/us/products/2834494>

Technical data

Product properties

Product type	Relay Module
Application	Universal
Operating mode	100% operating factor
Mechanical service life	3x 10 ⁷ cycles

Insulation characteristics

Overvoltage category	III
Pollution degree	3

Data management status

Date of last data management	01.04.2026
------------------------------	------------

Electrical properties

Service life electrical	see diagram
Maximum power dissipation for nominal condition	0.82 W
Test voltage (Winding/contact)	4 kV (50 Hz, 1 min., winding/contact)
Test voltage (Contact/contact)	2.5 kV (50 Hz, 1 min., contact/contact)

Input data

Coil side

Nominal input voltage U _N	24 V AC
Input voltage range	18.7 V AC ... 37.2 V AC
Drive and function	monostable
Typical input current at U _N	34 mA (at 50 Hz) 26 mA (At 60 Hz)
Typical response time	3 ms ... 12 ms
Typical release time range	1.5 ms ... 14 ms
Protective circuit	Varistor
Operating voltage display	Yellow LED

Output data

Switching

Contact switching type	2 changeover contacts
Type of switch contact	Single contact
Contact material	AgNi
Maximum switching voltage	250 V AC/DC
Minimum switching voltage	5 V (at 10 mA)
Limiting continuous current	8 A
Maximum inrush current	15 A (300 ms)
Min. switching current	10 mA (At 5 V)

PR1-RSC3-LV- 24AC/2X21 - Relay module



2834494

<https://www.phoenixcontact.com/us/products/2834494>

Interrupting rating (ohmic load) max.	2000 W (for 250 V AC)
	44 W (at 110 V DC)
	60 W (at 220 V DC)
	190 W (at 24 V DC)
	at 440 V AC
	85 W (at 48 V DC)
	60 W (at 60 V DC)
Switching capacity	2 A (at 24 V, DC13)
	0.2 A (at 250 V, DC13)
	3 A (at 24 V, AC15)
	3 A (at 120 V, AC15)
	3 A (at 250 V, AC15)

Connection data

Coil side

Connection method	Screw connection
Stripping length	8 mm
Screw thread	M3
Conductor cross-section rigid	0.14 mm ² ... 2.5 mm ²
Conductor cross-section flexible	0.14 mm ² ... 2.5 mm ²
Conductor cross-section AWG	26 ... 14

Contact side

Connection method	Screw connection
Stripping length	8 mm
Screw thread	M3
Conductor cross-section rigid	0.14 mm ² ... 2.5 mm ²
Conductor cross-section flexible	0.14 mm ² ... 2.5 mm ²
Conductor cross-section AWG	26 ... 14

Dimensions

Width	16 mm
Height	78.5 mm
Depth	71 mm

Material specifications

Color	green (RAL 6021)
-------	------------------

Environmental and real-life conditions

Ambient conditions

Ambient temperature (operation)	-25 °C ... 60 °C
Ambient temperature (storage/transport)	-25 °C ... 85 °C

Standards and regulations

PR1-RSC3-LV- 24AC/2X21 - Relay module



2834494

<https://www.phoenixcontact.com/us/products/2834494>

Standards/regulations	IEC 60664
	EN 50178

Mounting

Mounting type	DIN rail mounting
Assembly note	in rows with zero spacing
Mounting position	any

Drawings

Diagram

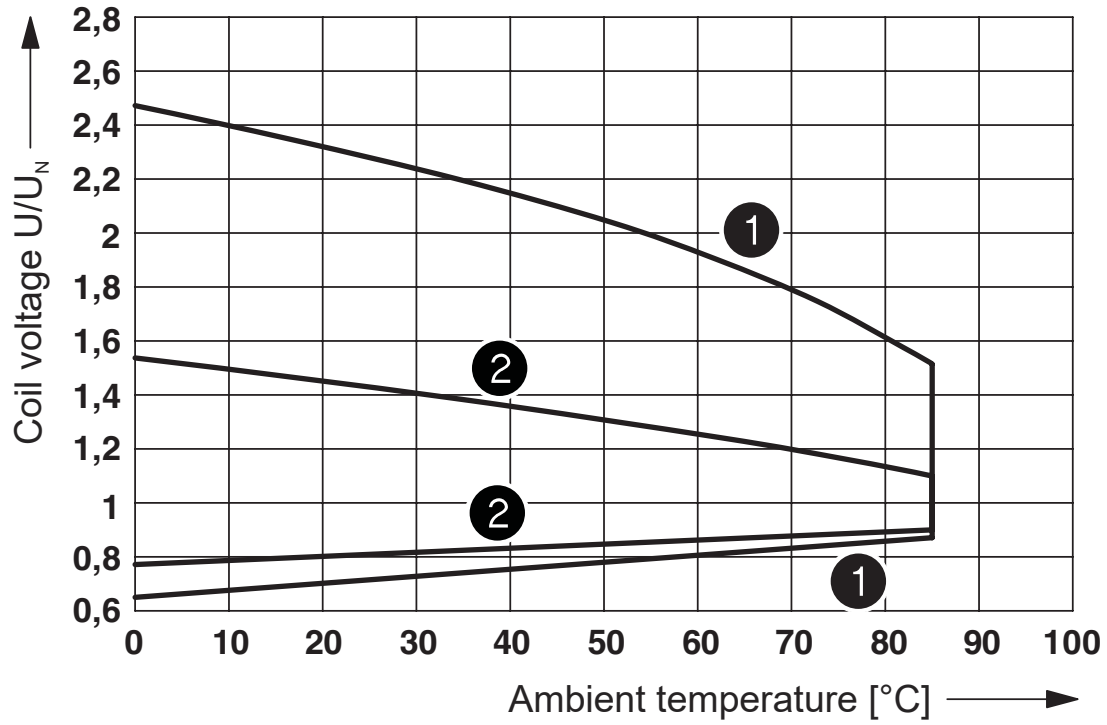

- ① DC coils
- ② AC coils

Operating voltage range of the relay

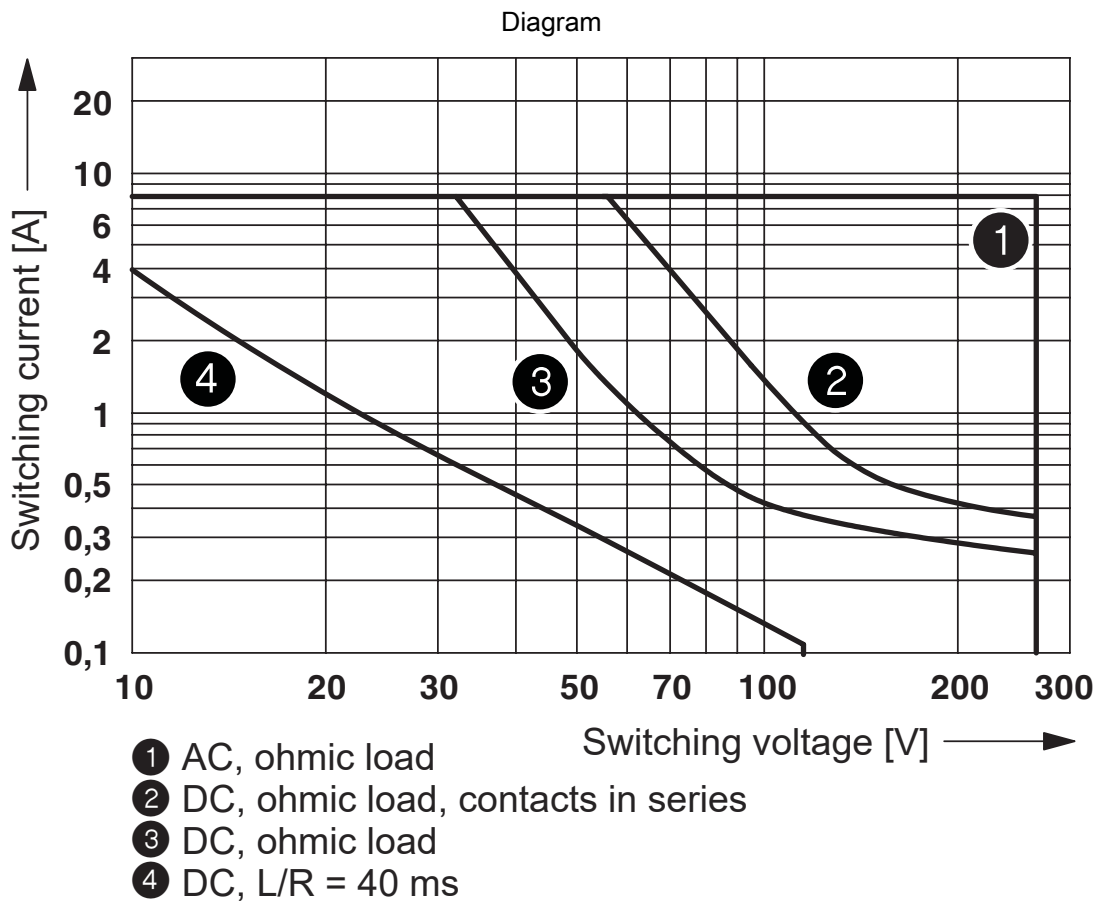

Interrupting rating

Diagram

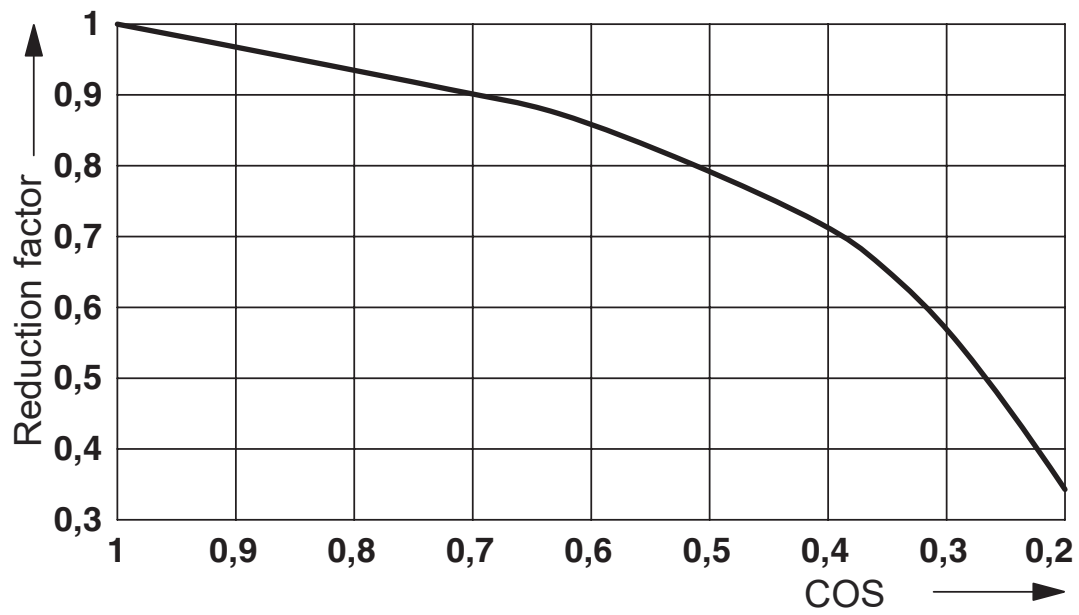

Service life reduction factor with various cos phi

Diagram

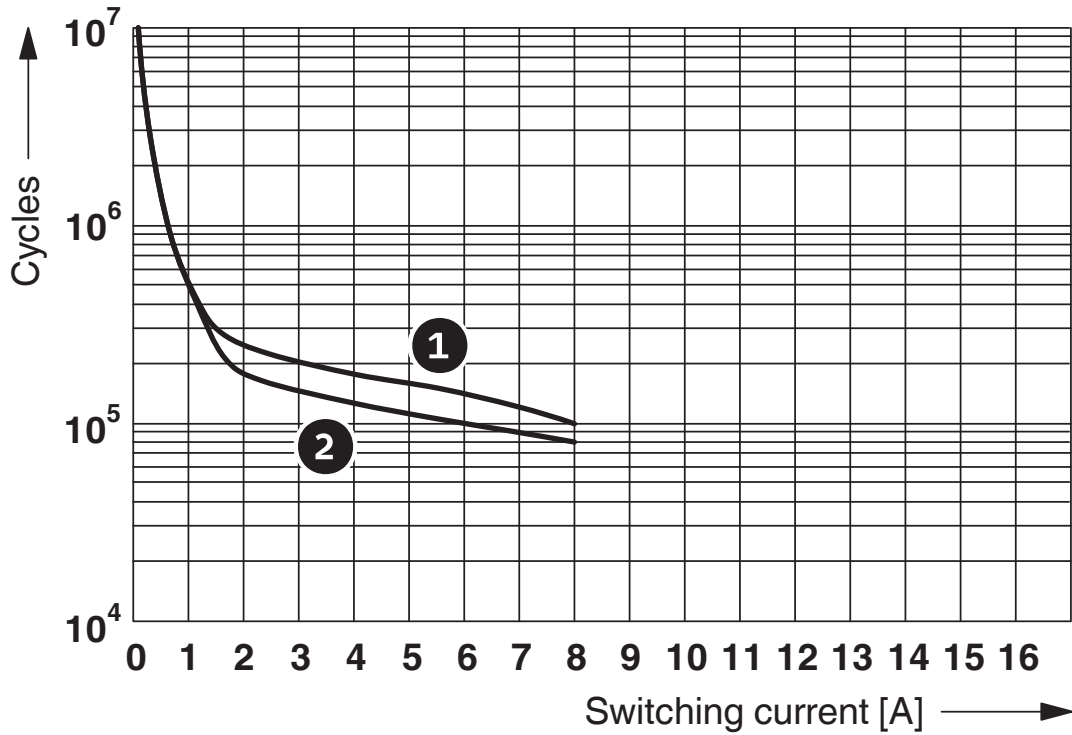

- ① 250 V AC, ohmic load (DC coils)
- ② 250 V AC, ohmic load (AC coils)

Electrical service life

PR1-RSC3-LV- 24AC/2X21 - Relay module



2834494

<https://www.phoenixcontact.com/us/products/2834494>

Circuit diagram

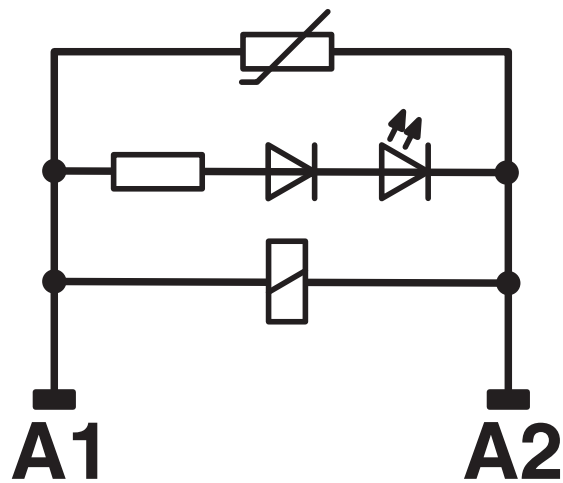
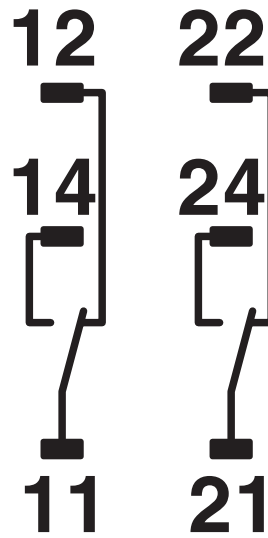

AC coils

PR1-RSC3-LV- 24AC/2X21 - Relay module



2834494

<https://www.phoenixcontact.com/us/products/2834494>

Classifications

UNSPSC

UNSPSC 21.0	39122334
-------------	----------

PR1-RSC3-LV- 24AC/2X21 - Relay module



2834494

<https://www.phoenixcontact.com/us/products/2834494>

Environmental product compliance

EU RoHS

Fulfills EU RoHS substance requirements	Yes, No exemptions
---	--------------------

China RoHS

Environment friendly use period (EFUP)	EFUP-E
	No hazardous substances above the limits

EU REACH SVHC

REACH candidate substance (CAS No.)	No substance above 0.1 wt%
-------------------------------------	----------------------------

Phoenix Contact 2026 © - all rights reserved
<https://www.phoenixcontact.com>

Phoenix Contact USA
586 Fulling Mill Road
Middletown, PA 17057, United States
(+717) 944-1300
info@phoenixcon.com