

MACX MCR-UI-UI-UP-NC - Input signal conditioner



2811297

<https://www.phoenixcontact.com/us/products/2811297>

Please be informed that the data shown in this PDF document is generated from our online catalog. Please find the complete data in the user documentation. Our general terms of use for downloads are valid.



Isolating amplifier with safe electrical isolation and wide-range power supply (24 V ... 230 V AC/DC). DIP switches on the front, over 1600 signal conversions can be set. Standard configuration (IN 0 ... 10 V/OUT 0 ... 20 mA), screw connection, SIL.

Your advantages

- Over 1600 signal conversions can be set via DIP switches on the front
- Up to SIL 2 in accordance with EN 61508
- Installation in zone 2 permitted
- Analog signal conditioner for isolating, filtering, amplifying, and converting standard analog signals
- Configurable input and output signals, including bipolar current and voltage signals
- Status indicator for supply voltage
- Wide-range power supply of 19.2 ... 253 V AC/DC
- Plug-in screw or spring-cage connection technology (Push-in technology)
- 3-way electrical isolation
- Active or passive output

Commercial data

Item number	2811297
Packing unit	1 pc
Minimum order quantity	1 pc
Sales key	C402
Product key	DK1111
GTIN	4046356288910
Weight per piece (including packing)	193.3 g
Weight per piece (excluding packing)	167.2 g
Customs tariff number	85437090
Country of origin	DE

Technical data

Product properties

Product type	Input signal conditioner
Product family	MACX Analog
No. of channels	1
Configuration	DIP switches

System properties

Functionality

Configuration	DIP switches
---------------	--------------

Electrical properties

Alignment span	$\pm 4 \%$
Alignment zero	$\pm 4 \%$
Electrical isolation between input and output	yes
Limit frequency (3 dB)	10 kHz (Can be switched to 30 Hz)
Maximum power dissipation for nominal condition	< 0.9 W (20 mA)
Protective circuit	Transient protection
Step response (10-90%)	35 μ s (10 kHz)
	11 ms (30 Hz)
Maximum temperature coefficient	0.0075 %/K
Maximum transmission error	$\leq 0.1 \%$ (Compared to the final value)

Electrical isolation

Test voltage	2.5 kV AC (50 Hz, 60 s)
Overvoltage category	II
Pollution degree	2

Electrical isolation Input/output/power supply IEC/EN 61010-1

Standards/regulations	IEC/EN 61010-1
Rated insulation voltage	300 V _{rms}
Insulation	Safe isolation

Electrical isolation Input/output/power supply IEC/EN 60079-7

Standards/regulations	IEC/EN 60079-7
Rated insulation voltage	275 V

Supply

Nominal supply voltage range	24 V AC/DC ... 230 V AC/DC -20 % ... +10 % (50/60 Hz)
Supply voltage range	19.2 V AC/DC ... 253 V AC/DC (50/60 Hz)
Power dissipation	< 0.8 W (at 24 V DC / 20 mA)
	< 0.9 W (At 230 V AC / 20 mA)

Input data

MACX MCR-UI-UI-UP-NC - Input signal conditioner



2811297

<https://www.phoenixcontact.com/us/products/2811297>

Signal: Voltage/current

Number of inputs	1
Voltage input signal	0 mV ... 50 mV
	0 mV ... 60 mV
	0 mV ... 75 mV
	0 mV ... 100 mV
	0 mV ... 120 mV
	0 mV ... 150 mV
	0 mV ... 200 mV
	0 mV ... 300 mV
	0 mV ... 500 mV
	0 V ... 1 V
	0 V ... 1.5 V
	0 V ... 2 V
	0 V ... 3 V
	0 V ... 5 V
	0 V ... 10 V (Configurable via DIP switches)
	0 V ... 15 V
	0 V ... 20 V
	0 V ... 30 V
	0 V ... 50 V
	0 V ... 100 V
	-50 mV ... 50 mV
	-60 mV ... 60 mV
	-75 mV ... 75 mV
	-100 mV ... 100 mV
	-120 mV ... 120 mV
	-150 mV ... 150 mV
	-200 mV ... 200 mV
	-300 mV ... 300 mV
	-500 mV ... 500 mV
	-1 V ... 1 V
	-1.5 V ... 1.5 V
	-2 V ... 2 V
	-3 V ... 3 V
	-5 V ... 5 V
-10 V ... 10 V	
-15 V ... 15 V	
-20 V ... 20 V	
-30 V ... 30 V	
-50 V ... 50 V	
-100 V ... 100 V	
1 V ... 5 V	

MACX MCR-UI-UI-UP-NC - Input signal conditioner



2811297

<https://www.phoenixcontact.com/us/products/2811297>

	2 V ... 10 V
Min. voltage input signal	± 50 mV
Max. voltage input signal	± 100 V
Current input signal	0 mA ... 1 mA (Configurable via DIP switches)
	0 mA ... 1.5 mA
	0 mA ... 2 mA
	0 mA ... 3 mA
	0 mA ... 5 mA
	0 mA ... 10 mA
	0 mA ... 15 mA
	0 mA ... 20 mA
	0 mA ... 30 mA
	0 mA ... 50 mA
	0 mA ... 100 mA
	-1 mA ... 1 mA
	-1.5 mA ... 1.5 mA
	-2 mA ... 2 mA
	-3 mA ... 3 mA
	-5 mA ... 5 mA
	-10 mA ... 10 mA
	-15 mA ... 15 mA
	-20 mA ... 20 mA
	-30 mA ... 30 mA
	-50 mA ... 50 mA
	-100 mA ... 100 mA
	1 mA ... 5 mA
	2 mA ... 10 mA
	4 mA ... 20 mA
Minimum current input signal	± 1 mA
Max. current input signal	± 100 mA
Input resistance of voltage input	approx. 1 MΩ (±1 V DC ... ±100 V DC)
Input resistance current input	approx. 10 Ω (±10 mA DC ... ±100 mA DC)

Output data

Signal: Voltage/current

Number of outputs	1
Configurable/programmable	Yes, can be switched
Voltage output signal	0 V ... 10 V (Configurable via DIP switches)
	0 V ... 5 V
	2 V ... 10 V
	1 V ... 5 V
	-10 V ... 10 V
	-5 V ... 5 V

MACX MCR-UI-UI-UP-NC - Input signal conditioner



2811297

<https://www.phoenixcontact.com/us/products/2811297>

	0 V ... 2.5 V
	0.5 V ... 2.5 V
	-2.5 V ... 2.5 V
Max. voltage output signal	15 V
Output signal voltage inverse	0 V ... 2.5 V
	0 V ... 5 V
	0 V ... 10 V
Current output signal	0 mA ... 5 mA
	0 mA ... 10 mA
	0 mA ... 20 mA (Configurable via DIP switches)
	1 mA ... 5 mA
	2 mA ... 10 mA
	4 mA ... 20 mA
	-5 mA ... 5 mA
	-10 mA ... 10 mA
	-20 mA ... 20 mA
Max. current output signal	35 mA
Output signal current inverse	0 mA ... 5 mA
	0 mA ... 10 mA
	0 mA ... 20 mA
Load/output load voltage output	$\geq 1 \text{ k}\Omega$ (10 V)
Load/output load current output	$\leq 600 \Omega$ (20 mA; active)
	passive: $\leq (U_B - 2 \text{ V}) / I_{\text{outmax}}$
Ripple	$< 10 \text{ mV}_{\text{rms}}$

Connection data

Connection method	Screw connection
Stripping length	7 mm
Screw thread	M3
Conductor cross-section rigid	0.2 mm ² ... 2.5 mm ²
Conductor cross-section flexible	0.2 mm ² ... 2.5 mm ²
Conductor cross-section AWG	24 ... 14
Tightening torque	0.5 Nm ... 0.6 Nm

Test socket

Max. diameter	2 mm
---------------	------

Ex data

Ex installation (EPL)	Gc
	Div. 2

Dimensions

2811297

<https://www.phoenixcontact.com/us/products/2811297>

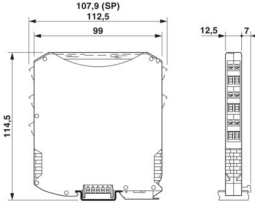
Dimensional drawing	
Width	12.5 mm
Height	112.5 mm
Depth	113.7 mm
Depth NS 35/7,5	114.5 mm (Snapped onto DIN rail NS 35/7,5 in accordance with EN 60715)

Material specifications

Color	gray (RAL 7042)
Housing material	PA 6.6-FR

Characteristics

Safety data: IEC 61508 - High demand

Safety Integrity Level (SIL)	2
------------------------------	---

Safety data: IEC 61508 - High demand

Safety Integrity Level (SIL)	2
------------------------------	---

Safety data: IEC 61508 - Low demand

Safety Integrity Level (SIL)	2
------------------------------	---

Safety data: IEC 61508 - Low demand

Safety Integrity Level (SIL)	2
------------------------------	---

Environmental and real-life conditions

Ambient conditions

Degree of protection	IP20 (not assessed by UL)
Ambient temperature (operation)	-20 °C ... 70 °C
Ambient temperature (storage/transport)	-40 °C ... 85 °C

Altitude range (\leq 2000 m)

Altitude	\leq 2000 m (The technical data refers to altitudes \leq 2000 m above mean sea level. For altitudes $>$ 2000 m above mean sea level, refer to the data sheet.)
Ambient temperature (operation)	-20 °C ... 70 °C
Safety-related maximum voltage U_m	275 V

Altitude range (\leq 3000 m)

Height range	$>$ 2000 m ... 3000 m
Ambient temperature (operation)	-20 °C ... 60 °C
Safety-related maximum voltage U_m	190 V

MACX MCR-UI-UI-UP-NC - Input signal conditioner



2811297

<https://www.phoenixcontact.com/us/products/2811297>

Altitude range (≤ 4000 m)

Height range	> 3000 m ... 4000 m
Ambient temperature (operation)	-20 °C ... 55 °C
Safety-related maximum voltage U_m	60 V

Altitude range (≤ 5000 m)

Height range	> 4000 m ... 5000 m
Ambient temperature (operation)	-20 °C ... 45 °C
Safety-related maximum voltage U_m	60 V

Approvals

CE

Certificate	CE-compliant
-------------	--------------

ATEX

Identification	Ⓜ II 3 G Ex nA IIC T4 Gc
Certificate	BVS 09 ATEX E 028 X

UKCA Ex (UKEX)

Identification	Ⓜ II 3 G Ex nA IIC T4 Gc
Certificate	PxCIF21UKEX2811459X

IECEX

Identification	Ex ec IIC T4 Gc
Certificate	IECEX BVS 09.0013X

CCC / China-Ex

Identification	Ex ec IIC T4 Gc
Certificate	2021122304114078

UL, USA/Canada

Identification	UL 61010 Listed
	Class I, Div. 2, Groups A, B, C, D T4
	Class I, Zone 2, Group IIC

Shipbuilding approval

Certificate	DNV GL TAA00000AG
-------------	-------------------

Safety Integrity Level (SIL, IEC 61508)

Identification	2
----------------	---

INMETRO

Identification	Ex ec IIC T4 Gc
Certificate	DNV 21.0125 X

EAC Ex

Identification	Ⓜ Ex ec IIC T4 Gc
Certificate	BY/112 02.01 TP012 103.01 00078

MACX MCR-UI-UI-UP-NC - Input signal conditioner



2811297

<https://www.phoenixcontact.com/us/products/2811297>

Shipbuilding data

Temperature	B
Humidity	B
Vibration	A
EMC	B
Enclosure	Required protection according to the Rules shall be provided upon installation on board

EMC data

Electromagnetic compatibility	Conformance with EMC directive
Noise immunity	EN 61000-6-2
Note	When being exposed to interference, there may be minimal deviations.

Noise emission

Standards/regulations	EN 61000-6-4
-----------------------	--------------

Electromagnetic HF field

Designation	Electromagnetic RF field
Standards/regulations	EN 61000-4-3
Typical deviation from the measuring range final value	1.9 %

Fast transients (burst)

Designation	Fast transients (burst)
Standards/regulations	EN 61000-4-4
Typical deviation from the measuring range final value	2 %

Conducted interference

Designation	Conducted interferences
Standards/regulations	EN 61000-4-6
Typical deviation from the measuring range final value	4.6 %

Standards and regulations

GB Standard

Standards/regulations	GB/T 3836.1
	GB/T 3836.3

Mounting

Mounting type	DIN rail mounting
Mounting position	any

MACX MCR-UI-UI-UP-NC - Input signal conditioner



2811297

<https://www.phoenixcontact.com/us/products/2811297>

Drawings

Dimensional drawing



MACX MCR-UI-UI-UP-NC - Input signal conditioner



2811297

<https://www.phoenixcontact.com/us/products/2811297>

Block diagram



2811297

<https://www.phoenixcontact.com/us/products/2811297>

Approvals

To download certificates, visit the product detail page: <https://www.phoenixcontact.com/us/products/2811297>

 **UL Listed**
Approval ID: E330267

 **cUL Listed**
Approval ID: E330267

Functional Safety
Approval ID: BVS Pb 02/09

DNV
Approval ID: TAA00000AG

 **EAC Ex**
Approval ID: BY/112 02.01 TP012xx

 **cUL Listed**
Approval ID: E199827

 **UL Listed**
Approval ID: FILE E 199827

 **IECEx**
Approval ID: IECEx BVS 09.0013X

 **ATEX**
Approval ID: BVS 09 ATEX E 028 X

INMETRO
Approval ID: DNV 21.0125 X

 **CCC**
Approval ID: 2021122304114078

MACX MCR-UI-UI-UP-NC - Input signal conditioner



2811297

<https://www.phoenixcontact.com/us/products/2811297>

Classifications

ECLASS

ECLASS-13.0	27210120
ECLASS-15.0	27210120

ETIM

ETIM 10.0	EC002653
-----------	----------

UNSPSC

UNSPSC 21.0	39121000
-------------	----------

Environmental product compliance

EU RoHS

Fulfills EU RoHS substance requirements	Yes
Exemption	6(c), 7(a), 7(c)-I

China RoHS

Environment friendly use period (EFUP)	EFUP-50
	An article-related China RoHS declaration table can be found in the download area for the respective article under "Manufacturer declaration". For all articles with EFUP-E, no China RoHS declaration table issued and required.

EU REACH SVHC

REACH candidate substance (CAS No.)	Lead(CAS: 7439-92-1)
	6,6'-di-tert-butyl-2,2'-methylenedi-p-cresol(CAS: 119-47-1)
	2,2',6,6'-tetrabromo-4,4'-isopropylidenediphenol(CAS: 79-94-7)
SCIP	a363c996-4e34-492c-94cf-5cd6c910a825

Phoenix Contact 2026 © - all rights reserved
<https://www.phoenixcontact.com>

Phoenix Contact USA
 586 Fulling Mill Road
 Middletown, PA 17057, United States
 (+717) 944-1300
info@phoenixcon.com