

VAL-SQ SE 200-120/208Y-R - Type 2 surge protection replacement module



2804270

<https://www.phoenixcontact.com/us/products/2804270>

Please be informed that the data shown in this PDF document is generated from our online catalog. Please find the complete data in the user documentation. Our general terms of use for downloads are valid.

Replacement module, 200 kA surge protection, 120/208 V AC Wye system



Commercial data

Item number	2804270
Packing unit	1 pc
Note	Made to order (non-returnable)
Sales key	CL01
Product key	CL1615
GTIN	4046356317412
Weight per piece (including packing)	4.012 kg
Weight per piece (excluding packing)	4.012 kg
Customs tariff number	85363010
Country of origin	US

VAL-SQ SE 200-120/208Y-R - Type 2 surge protection replacement module



2804270

<https://www.phoenixcontact.com/us/products/2804270>

Technical data

Product properties

Type	Parallel MOV
------	--------------

Electrical properties

General

Power Systems	120/208 V AC Wye
---------------	------------------

Connection data

Connection method	Screw terminal blocks
Tightening torque, min	4 Nm

Protective circuit

Direction of action	3L-N & N-GND
Maximum continuous operating voltage U_C	150 V
Response time t_A	< 1 ns

Environmental and real-life conditions

Ambient conditions

Ambient temperature (operation)	-40 °C ... 60 °C
Ambient temperature (storage/transport)	-40 °C ... 85 °C
Altitude	3658 m

Approvals

UL specifications

Short-circuit current rating (SCCR)	200 kA
Maximum Surge Current per Phase	200 kA

VAL-SQ SE 200-120/208Y-R - Type 2 surge protection replacement module



2804270

<https://www.phoenixcontact.com/us/products/2804270>

Drawings

Circuit diagram

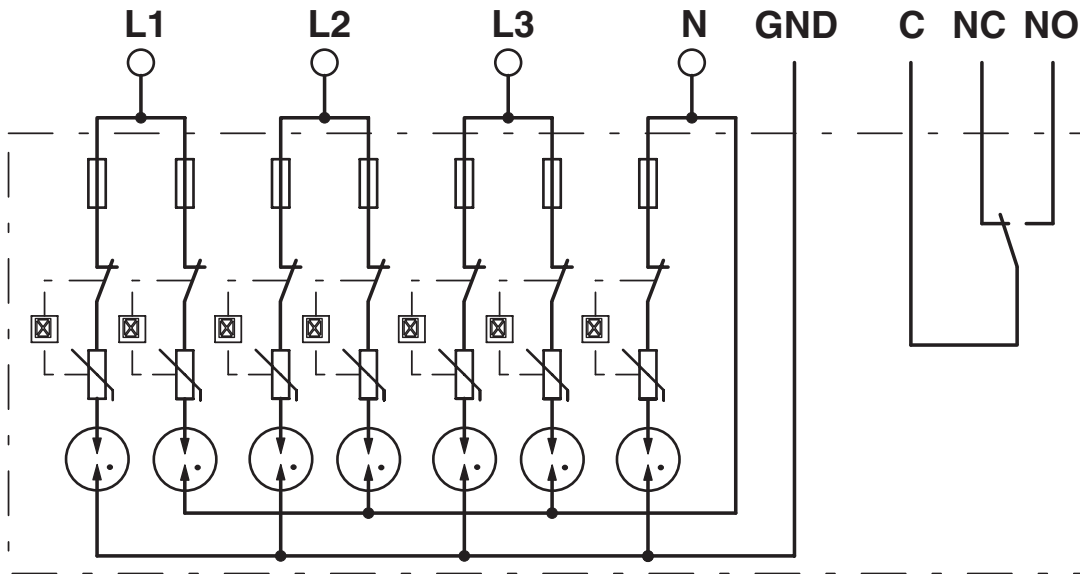

VAL-SQ SE 200-120/208Y-R - Type 2 surge protection replacement module



2804270

<https://www.phoenixcontact.com/us/products/2804270>

Environmental product compliance

EU REACH SVHC

REACH candidate substance (CAS No.)	No substance above 0.1 wt%
-------------------------------------	----------------------------

Phoenix Contact 2026 © - all rights reserved

<https://www.phoenixcontact.com>

Phoenix Contact USA
586 Fulling Mill Road
Middletown, PA 17057, United States
(+717) 944-1300
info@phoenixcon.com