

# PLC-V8/D15S/OUT - System connection



2296058

<https://www.phoenixcontact.com/us/products/2296058>

Please be informed that the data shown in this PDF document is generated from our online catalog. Please find the complete data in the user documentation. Our general terms of use for downloads are valid.



V8 adapter for 8 x PLC-INTERFACE (6.2 mm), controller: PLC system cabling of output cards, connection 1: D-SUB pin strip 1x 15-position, connection 2: Plug-in connection (Can be snapped onto 8x PLC-INTERFACE terminals), connection 3: Screw connection 1x 2-position, number of channels: 8, control logic: positive switching

## Commercial data

Item number	2296058
Packing unit	1 pc
Minimum order quantity	1 pc
Sales key	C421
Product key	DK21D2
GTIN	4017918189105
Weight per piece (including packing)	109.8 g
Weight per piece (excluding packing)	50 g
Customs tariff number	85366990
Country of origin	DE

## Technical data

### Product properties

Product type	Interface module
Product family	PLC-INTERFACE
Number of positions	15
No. of channels	8

### Insulation characteristics: Air clearances and creepage distances

Insulation	Functional insulation
Overvoltage category	II
Pollution degree	2

### Electrical properties

Operating voltage range	18 V DC ... 33.6 V DC
Current (per branch)	≤ 1 A
Current (Power supply)	≤ 3 A

### Air clearances and creepage distances

Rated insulation voltage	50 V
Rated surge voltage	0.5 kV (1.2/50 μs)

### Supported controller: universal

Suitable I/O card	universal
-------------------	-----------

## Connection data

### Connection 1 (control level)

Connection in acc. with standard	IEC 60807-2
Connection method	D-SUB pin strip
Screw thread	UNC 4-40
Number of connections	1
Number of positions	15
Insertion/withdrawal cycles	> 500
Pitch	2.74 mm

### Connection 2 (field level)

Connection method	Plug-in connection
Note	Can be snapped onto 8x PLC-INTERFACE terminals

### Connection 3 (supply)

Connection method	Screw connection
Stripping length	8 mm
Screw thread	M3
Number of connections	1
Number of positions	2

# PLC-V8/D15S/OUT - System connection



2296058

<https://www.phoenixcontact.com/us/products/2296058>

Conductor cross-section rigid	0.2 mm <sup>2</sup> ... 4 mm <sup>2</sup>
Conductor cross-section rigid (2 conductors with same cross section)	0.2 mm <sup>2</sup> ... 1.5 mm <sup>2</sup>
Conductor cross-section flexible	0.2 mm <sup>2</sup> ... 2.5 mm <sup>2</sup>
	0.25 mm <sup>2</sup> ... 2.5 mm <sup>2</sup> (Ferrule without plastic sleeve)
	0.25 mm <sup>2</sup> ... 2.5 mm <sup>2</sup> (Ferrule with plastic sleeve)
Conductor cross-section flexible (2 conductors with same cross section)	0.2 mm <sup>2</sup> ... 1.5 mm <sup>2</sup>
	0.25 mm <sup>2</sup> ... 0.75 mm <sup>2</sup> (Ferrule without plastic sleeve)
	0.5 mm <sup>2</sup> ... 1.5 mm <sup>2</sup> (TWIN ferrule with plastic sleeve)
Conductor cross-section AWG	24 ... 12
Tightening torque	0.5 Nm ... 0.6 Nm
Pitch	5 mm

## Signaling

Status display present	yes
Operating voltage display	Green LED

## Dimensions

### Item dimensions

Width	49.92 mm
Height	41 mm
Depth	49.86 mm

## Material specifications

Color	gray (RAL 7042)
Flammability rating according to UL 94	V0
Housing insulation material	Polyamide 6.6 green

## Environmental and real-life conditions

### Ambient conditions

Degree of protection (Module)	IP20
Degree of protection (Installation location)	≥ IP54
Ambient temperature (operation)	-40 °C ... 70 °C
Ambient temperature (storage/transport)	-40 °C ... 70 °C
Altitude	≤ 2000 m

## Approvals

### CE

Certificate	CE-compliant
-------------	--------------

### UKCA

Certificate	UKCA-compliant
-------------	----------------

### UL, USA/Canada

# PLC-V8/D15S/OUT - System connection



2296058

<https://www.phoenixcontact.com/us/products/2296058>

Identification	Class I, Div. 2, Groups A, B, C, D T4
----------------	---------------------------------------

## UL, Canada

Identification	Class I, Zone 2, Ex ec IIC Gc T4 X
----------------	------------------------------------

## UL, USA

Identification	Class I, Zone 2, AEx ec IIC T4
----------------	--------------------------------

## Shipbuilding approval

Certificate	TAE0000196
-------------	------------

## Shipbuilding data

Temperature	D
Humidity	A
Vibration	C
EMC	B
Enclosure	Required protection according to the Rules shall be provided upon installation on board

## EMC data

Electromagnetic compatibility	Conformance with EMC directive
Low Voltage Directive	Conformance with Low Voltage Directive

## Standards and regulations

### Air clearances and creepage distances

Standards/regulations	EN IEC 60664-1
-----------------------	----------------

## Mounting

Mounting type	Plug-on assembly
Assembly note	in rows with zero spacing
Mounting position	any

## Notes

Notes on operation	For proper use, the specifications of the installation directive (see Downloads) must be observed. For applications or use with third-party products, the specifications, and the safety and warning instructions of the respective third-party manufacturer must also be met.
--------------------	--

## Drawings

Dimensional drawing

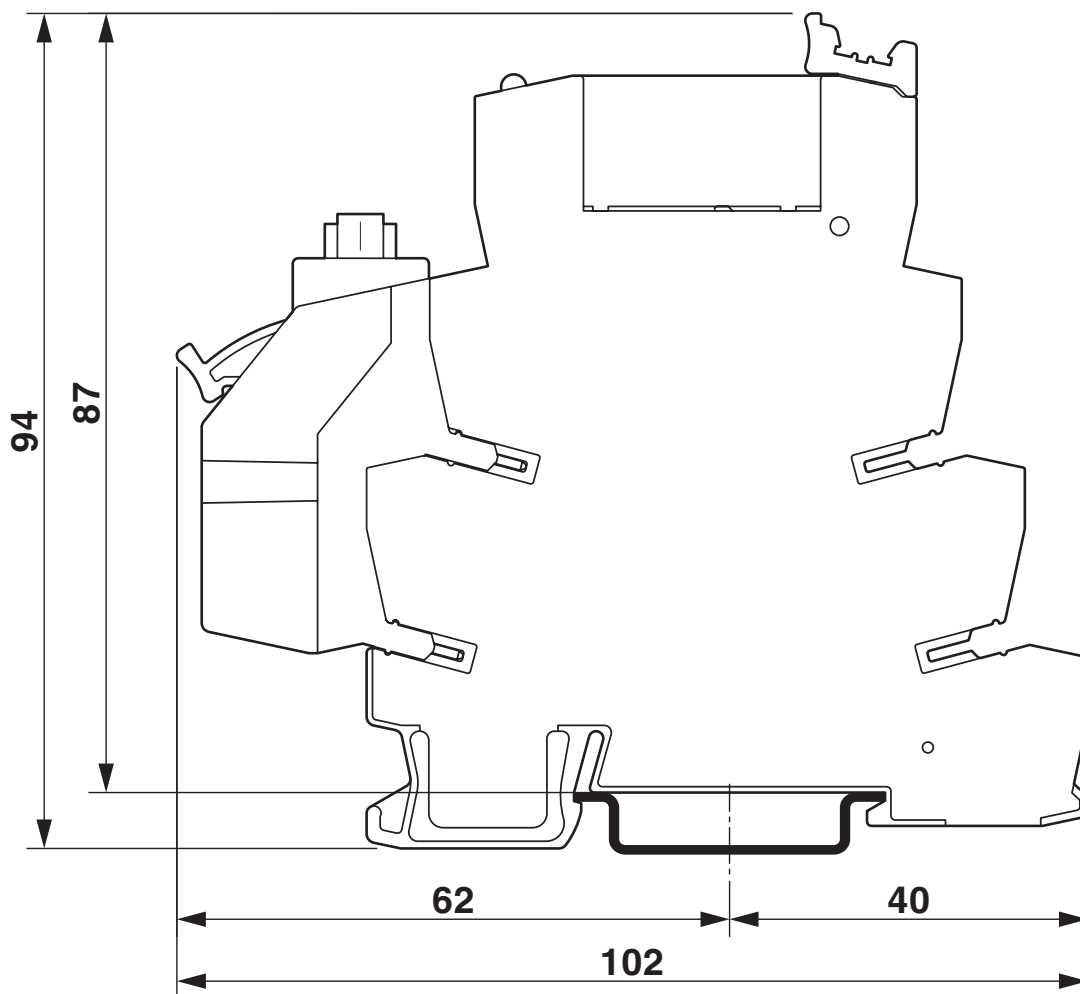

# PLC-V8/D15S/OUT - System connection

2296058

<https://www.phoenixcontact.com/us/products/2296058>

Circuit diagram

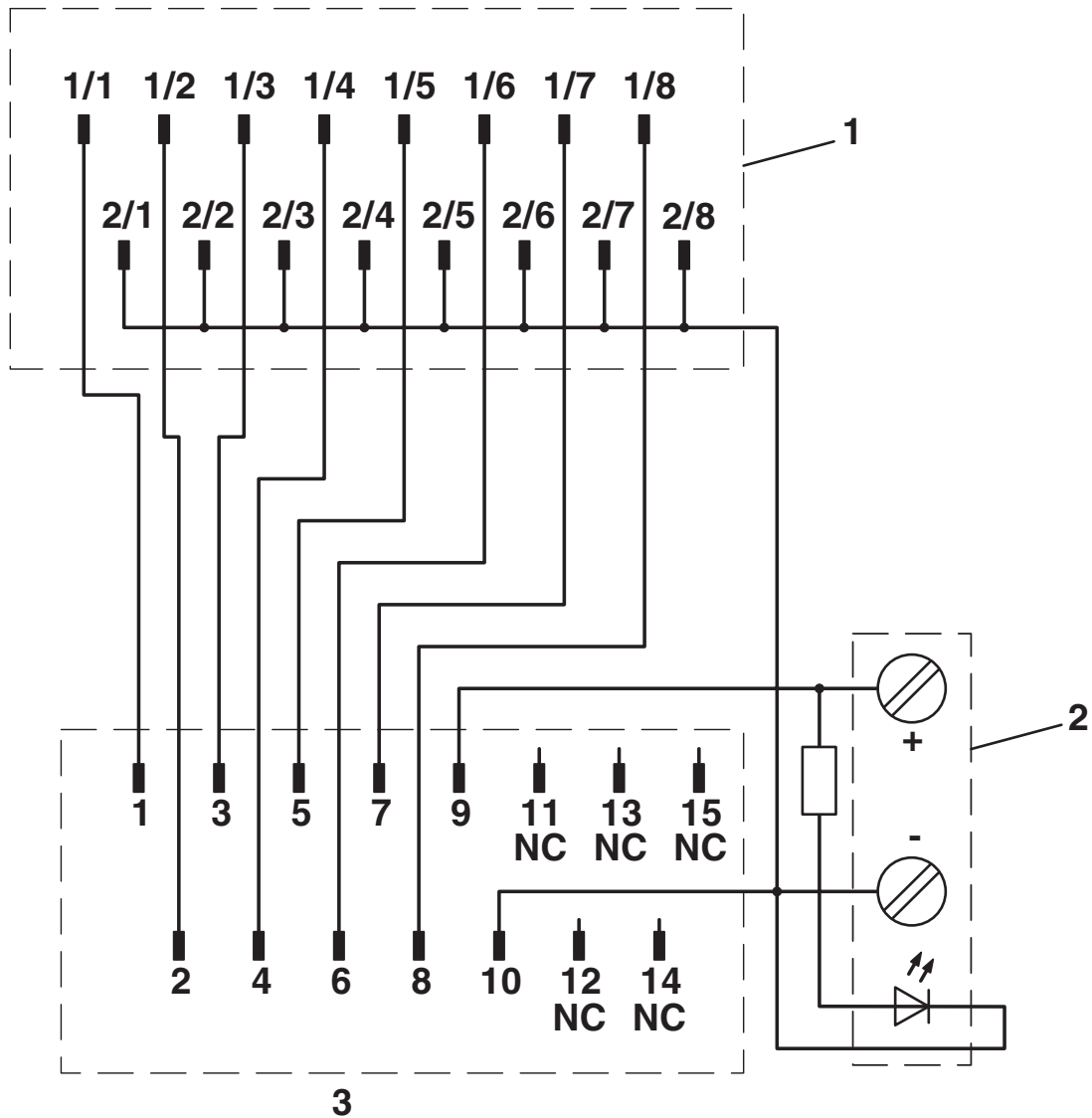

1 = contacting with PLC terminal blocks

2 = power terminal blocks

3 = D-SUB strip 15-pos.

# PLC-V8/D15S/OUT - System connection





2296058

<https://www.phoenixcontact.com/us/products/2296058>

## Approvals

To download certificates, visit the product detail page: <https://www.phoenixcontact.com/us/products/2296058>

 <b>cUL Recognized</b> Approval ID: E238705				
	Nominal voltage $U_N$	Nominal current $I_N$	Cross section AWG	Cross section $\text{mm}^2$
keine				
	24 V	1 A	-	-

 <b>UL Recognized</b> Approval ID: E238705				
	Nominal voltage $U_N$	Nominal current $I_N$	Cross section AWG	Cross section $\text{mm}^2$
keine				
	24 V	1 A	-	-

 <b>UL Listed</b> Approval ID: FILE E 172140				
--	--	--	--	--

 <b>cUL Listed</b> Approval ID: FILE E 172140				
---	--	--	--	--

<b>DNV</b> Approval ID: TAE0000196				
---------------------------------------	--	--	--	--

 <b>cUL Listed</b> Approval ID: E199827				
---	--	--	--	--

 <b>UL Listed</b> Approval ID: E199827				
--	--	--	--	--

# PLC-V8/D15S/OUT - System connection



2296058

<https://www.phoenixcontact.com/us/products/2296058>

## Classifications

### ECLASS

ECLASS-13.0	27141152
ECLASS-15.0	27141152

### ETIM

ETIM 10.0	EC002780
-----------	----------

### UNSPSC

UNSPSC 21.0	39121400
-------------	----------

2296058

<https://www.phoenixcontact.com/us/products/2296058>

## Environmental product compliance

### EU RoHS

Fulfills EU RoHS substance requirements	Yes
Exemption	6(c)

### China RoHS

Environment friendly use period (EFUP)	EFUP-50
	An article-related China RoHS declaration table can be found in the download area for the respective article under "Manufacturer declaration". For all articles with EFUP-E, no China RoHS declaration table issued and required.

### EU REACH SVHC

REACH candidate substance (CAS No.)	Hexahydromethylphthalic anhydride(CAS: n/a)
	Lead(CAS: 7439-92-1)
SCIP	c6f8eaae-6895-44cc-8c16-c72ba07c5a0e

Phoenix Contact 2026 © - all rights reserved  
<https://www.phoenixcontact.com>

Phoenix Contact USA  
586 Fulling Mill Road  
Middletown, PA 17057, United States  
(+717) 944-1300  
[info@phoenixcon.com](mailto:info@phoenixcon.com)