

PACT MCR-V2-3015- 60- 150-5A-1 - Current transformer



2277077

<https://www.phoenixcontact.com/us/products/2277077>

Please be informed that the data shown in this PDF document is generated from our online catalog. Please find the complete data in the user documentation. Our general terms of use for downloads are valid.



Window-type current transformer, 150 A AC primary current; 5 A AC secondary current; accuracy class 1; 5 VA rated power

Commercial data

Item number	2277077
Packing unit	1 pc
Minimum order quantity	1 pc
Sales key	C444
Product key	CMMA11
GTIN	4046356305099
Weight per piece (including packing)	315.5 g
Weight per piece (excluding packing)	270.9 g
Customs tariff number	85043129
Country of origin	DE

PACT MCR-V2-3015- 60- 150-5A-1 - Current transformer



2277077

<https://www.phoenixcontact.com/us/products/2277077>

Technical data

Product properties

Product type	Current transformer
Product family	Window-type current transformer

Electrical properties

Rated insulation voltage	1 kV (Phase/neutral conductor)
--------------------------	--------------------------------

General

Can be calibrated	no
Converter type	Window-type current transformer

Input data

Current transformer

Rated power	5 VA
Thermal rated short-time current	$I_{th} = 60 * I_n$
Thermal rated continuous current	$I_d = 1.2 * I_n$
Rated surge current	$I_{dyn} = 2.5 * I_{th}$
Rated frequency f_n	50 Hz 60 Hz
Primary rated current I_{pn}	0 A AC ... 150 A AC
Can be calibrated	no
Converter type	Window-type current transformer

Output data

Signal

Designation	Current output
Secondary rated current I_{sn}	5 A AC
Surge current limitation factor	FS 5
Accuracy class	1

Connection data

Connection method	Screw connection
Stripping length	10 mm
Conductor cross-section flexible	2x 10 mm ² ... 10 mm ² (Secondary terminals)
Tightening torque	2 Nm ... 2 Nm

Dimensions

Item dimensions

Width	31 mm
Height	82 mm
Depth	60 mm

PACT MCR-V2-3015- 60- 150-5A-1 - Current transformer



2277077

<https://www.phoenixcontact.com/us/products/2277077>

Item dimensions with alternative mounting

Width	60 mm
Height	82 mm
Depth	31 mm

Copper rail

Width	30 mm
Height	15 mm

Copper rail 2

Width	20 mm
Height	20 mm

Circular conductor

Diameter	28 mm
----------	-------

Drill hole

Diameter	6.5 mm
----------	--------

Material specifications

Color	gray (RAL 7042)
Flammability rating according to UL 94	V0 (Housing)
Housing material	PA 6.6

Environmental and real-life conditions

Ambient conditions

Ambient temperature (operation)	-25 °C ... 40 °C
Ambient temperature (storage/transport)	-25 °C ... 40 °C
Altitude	≤ 1000 m
Permissible humidity (operation)	Use only indoors, non-condensing
Insulating material class	H

Approvals

CE

Certificate	CE-compliant
-------------	--------------

UKCA

Certificate	UKCA-compliant
-------------	----------------

UL, USA/Canada

Identification	XODW8.E323953
----------------	---------------

Standards and regulations

Standards/regulations	EN 61869
-----------------------	----------

Mounting

PACT MCR-V2-3015- 60- 150-5A-1 - Current transformer



2277077

<https://www.phoenixcontact.com/us/products/2277077>

Mounting type	DIN rail mounting
	Panel mounting

PACT MCR-V2-3015- 60- 150-5A-1 - Current transformer



2277077

<https://www.phoenixcontact.com/us/products/2277077>

Drawings

Dimensional drawing

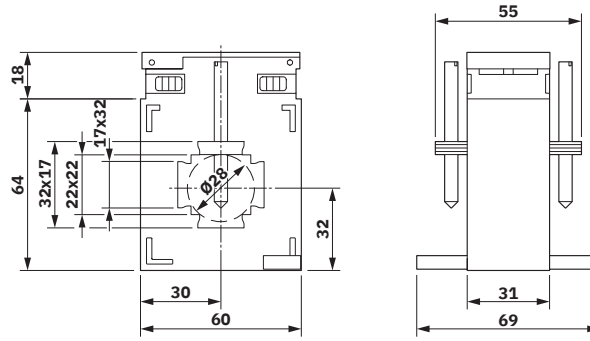

PACT MCR-V2-3015- 60- 150-5A-1 - Current transformer



2277077

<https://www.phoenixcontact.com/us/products/2277077>

Approvals

To download certificates, visit the product detail page: <https://www.phoenixcontact.com/us/products/2277077>



cULus Recognized
Approval ID: E323953

PACT MCR-V2-3015- 60- 150-5A-1 - Current transformer



2277077

<https://www.phoenixcontact.com/us/products/2277077>

Classifications

ECLASS

ECLASS-13.0	27210902
ECLASS-15.0	27210902

ETIM

ETIM 10.0	EC002048
-----------	----------

UNSPSC

UNSPSC 21.0	39121000
-------------	----------

PACT MCR-V2-3015- 60- 150-5A-1 - Current transformer



2277077

<https://www.phoenixcontact.com/us/products/2277077>

Environmental product compliance

EU RoHS

Fulfills EU RoHS substance requirements	Yes, No exemptions
-----------------------------------------	--------------------

China RoHS

Environment friendly use period (EFUP)	EFUP-E
	No hazardous substances above the limits

EU REACH SVHC

REACH candidate substance (CAS No.)	No substance above 0.1 wt%
-------------------------------------	----------------------------

Phoenix Contact 2026 © - all rights reserved
<https://www.phoenixcontact.com>

Phoenix Contact USA
586 Fulling Mill Road
Middletown, PA 17057, United States
(+717) 944-1300
info@phoenixcon.com