

# EH 70 F-C CS/ABS GY7035 - Upper housing part



2201836

<https://www.phoenixcontact.com/us/products/2201836>

Please be informed that the data shown in this PDF document is generated from our online catalog. Please find the complete data in the user documentation. Our general terms of use for downloads are valid.

DIN rail housing, Upper housing part, flat design, no connection opening, width: 70.1 mm, height: 74.65 mm, depth: 36.95 mm, color: light gray (similar RAL 7035)



## Your advantages

- DIN rail or panel mounting for application-specific device attachment
- Easy design-in, thanks to variable housing form factor
- Complete flexibility, thanks to PCBs with horizontal, frontal, and orthogonal orientation to the front of the device
- Three cover versions for individual PCB connections
- Integration of a wide variety of PCB connection technologies for a functional device design

## Commercial data

Item number	2201836
Packing unit	10 pc
Minimum order quantity	10 pc
Sales key	AC12
Product key	ACHCHC
GTIN	4046356912112
Weight per piece (including packing)	33.03 g
Weight per piece (excluding packing)	33.03 g
Customs tariff number	84879090
Country of origin	IN

## Technical data

### Notes

Assembly note	Please observe the application note in the download area.
---------------	---

### Product properties

Product type	Upper housing part
Housing type	DIN rail housing
Housing type	Basic housing
Housing series	EH
Product family	EH..F..ABS..
Number (Connection openings)	0
Ventilation openings present	yes

### Dimensions

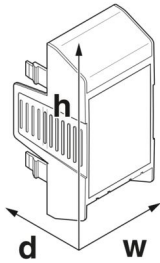
Dimensional drawing	
Width	70.1 mm
Height	74.65 mm
Depth	36.95 mm

### Material specifications

Color (Upper housing part)	light gray (RAL 7035)
Material Upper housing part	ABS
Flammability rating according to UL 94	HB

### Environmental and real-life conditions

#### Ambient conditions

Max. IP code to attain	IP20
Ambient temperature (operation)	-40 °C ... 80 °C (depending on power dissipation)
Ambient temperature (storage/transport)	-40 °C ... 55 °C
Ambient temperature (assembly)	-5 °C ... 80 °C
Relative humidity (storage/transport)	95 %

### PCB data

Type of PCB mount	Latching
-------------------	----------

# EH 70 F-C CS/ABS GY7035 - Upper housing part



2201836

<https://www.phoenixcontact.com/us/products/2201836>

## Mounting

Mounting type

Snap in

# EH 70 F-C CS/ABS GY7035 - Upper housing part

2201836

<https://www.phoenixcontact.com/us/products/2201836>



## Drawings

Dimensional drawing



Schematic figure for illustrating the item dimensions. The figure is not of the desired product. For further details, refer to the product drawings in the "Downloads" tab.

# EH 70 F-C CS/ABS GY7035 - Upper housing part



2201836

<https://www.phoenixcontact.com/us/products/2201836>

## Classifications

### ECLASS

ECLASS-13.0	27190603
ECLASS-15.0	27190603

### ETIM

ETIM 9.0	EC002779
----------	----------

### UNSPSC

UNSPSC 21.0	31261500
-------------	----------

# EH 70 F-C CS/ABS GY7035 - Upper housing part



2201836

<https://www.phoenixcontact.com/us/products/2201836>

## Environmental product compliance

### EU RoHS

Fulfills EU RoHS substance requirements	Yes, No exemptions
---	--------------------

### China RoHS

Environment friendly use period (EFUP)	EFUP-E
	No hazardous substances above the limits

### EU REACH SVHC

REACH candidate substance (CAS No.)	No substance above 0.1 wt%
-------------------------------------	----------------------------

Phoenix Contact 2026 © - all rights reserved  
<https://www.phoenixcontact.com>

Phoenix Contact USA  
586 Fulling Mill Road  
Middletown, PA 17057, United States  
(+717) 944-1300  
[info@phoenixcon.com](mailto:info@phoenixcon.com)