

UM-ALU 4 AU45 L130 - Profile cover



2200957

<https://www.phoenixcontact.com/us/products/2200957>

Please be informed that the data shown in this PDF document is generated from our online catalog. Please find the complete data in the user documentation. Our general terms of use for downloads are valid.



Press-drawn section housings, Screw mounting, Profile cover, width: 45.6 mm, profile width (internal): 42 mm, profile width (external): 45.6 mm, length: 130 mm, depth: 28.1 mm

Your advantages

- Aluminum extruded profile
- Variety of connection technology
- Can be mounted on the DIN rail
- Available in lengths from 42.5 mm ... 990 mm, can be cut to any length
- Available in overall widths of 75 mm and 105 mm
- EMC protection

Commercial data

Item number	2200957
Packing unit	1 pc
Minimum order quantity	1 pc
Sales key	AC14
Product key	ACHDFC
GTIN	4046356721004
Weight per piece (including packing)	72 g
Weight per piece (excluding packing)	72 g
Customs tariff number	76042990
Country of origin	HU

UM-ALU 4 AU45 L130 - Profile cover

2200957

<https://www.phoenixcontact.com/us/products/2200957>

Technical data

Product properties

Product type	Component housing cover
Housing type	Press-drawn section housings
Housing series	UM-ALU
Product family	UM-ALU
Ventilation openings present	no

Dimensions

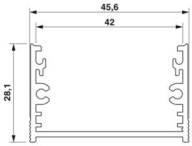
Dimensional drawing	
Width	45.6 mm
Depth	28.1 mm
Length	130 mm

External dimensions

Profile width (external)	45.6 mm
--------------------------	---------

Internal dimensions

Profile width (internal)	42 mm
--------------------------	-------

PCB design

PCB thickness	1.44 mm ... 2 mm
---------------	------------------

Material specifications

Color (Housing)	aluminum color
Material Housing	Anodized aluminum (anodized)
Surface characteristics	anodized

Environmental and real-life conditions

Ambient conditions

Max. IP code to attain	IP40
Ambient temperature (operation)	-40 °C ... 100 °C (depending on power dissipation)
Ambient temperature (storage/transport)	-40 °C ... 55 °C
Ambient temperature (assembly)	-5 °C ... 100 °C

PCB data

Number of PCB holders	4
Type of PCB mount	Slot
PCB surface	3565 mm ² ... 5003 mm ² (TOP in conjunction with side elements COVERLID...AL or 4LID...PA)

UM-ALU 4 AU45 L130 - Profile cover



2200957

<https://www.phoenixcontact.com/us/products/2200957>

	3399 mm ² ... 4874 mm ² (BOTTOM in conjunction with side elements COVERLID...AL or 4LID...PA)
Thickness of the PCB	1.44 mm ... 2 mm

Mounting

Mounting type	Screw mounting
Mounting position	parallel to the DIN rail

Packaging specifications

Type of packaging	packed in cardboard
Outer packaging type	Carton

UM-ALU 4 AU45 L130 - Profile cover



2200957

<https://www.phoenixcontact.com/us/products/2200957>

Drawings

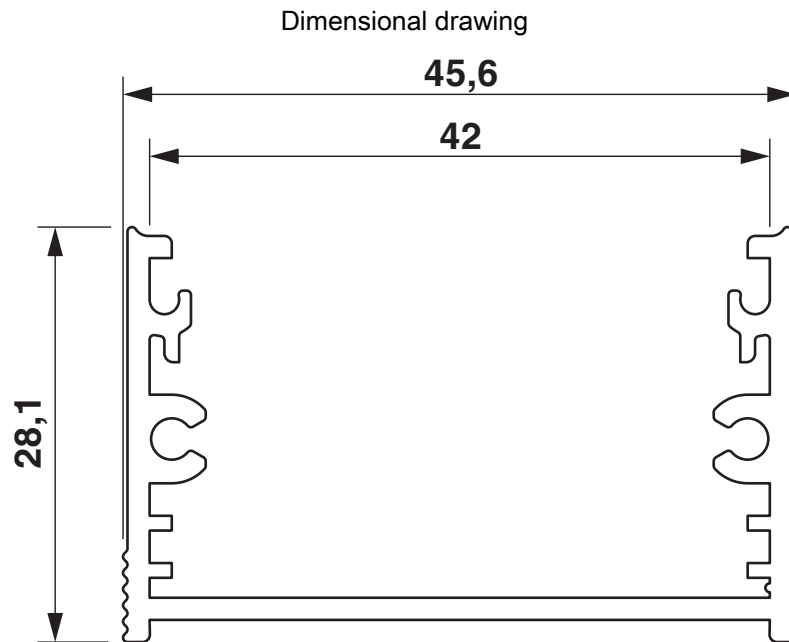

UM-ALU 4 AU45 L130 - Profile cover

2200957

<https://www.phoenixcontact.com/us/products/2200957>



Schematic diagram

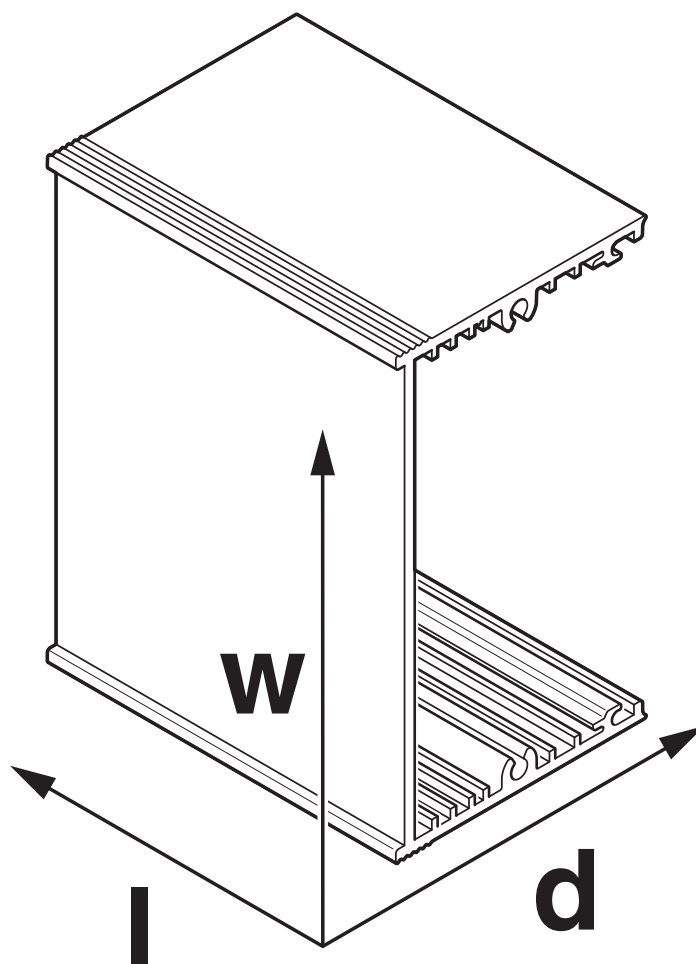

UM-ALU 4 AU45 L130 - Profile cover



2200957

<https://www.phoenixcontact.com/us/products/2200957>

Classifications

ECLASS

ECLASS-13.0	27190603
ECLASS-15.0	27190603

ETIM

ETIM 9.0	EC002779
----------	----------

UNSPSC

UNSPSC 21.0	31261500
-------------	----------

UM-ALU 4 AU45 L130 - Profile cover



2200957

<https://www.phoenixcontact.com/us/products/2200957>

Environmental product compliance

EU RoHS

Fulfills EU RoHS substance requirements	Yes, No exemptions
---	--------------------

China RoHS

Environment friendly use period (EFUP)	EFUP-E
	No hazardous substances above the limits

EU REACH SVHC

REACH candidate substance (CAS No.)	No substance above 0.1 wt%
-------------------------------------	----------------------------

Phoenix Contact 2026 © - all rights reserved
<https://www.phoenixcontact.com>

Phoenix Contact USA
586 Fulling Mill Road
Middletown, PA 17057, United States
(+717) 944-1300
info@phoenixcon.com