

UM-ALU 4-100,5 PROFILE 95 - Profile



2200937

<https://www.phoenixcontact.com/us/products/2200937>

Please be informed that the data shown in this PDF document is generated from our online catalog. Please find the complete data in the user documentation. Our general terms of use for downloads are valid.

Press-drawn section housings, Screw mounting, Basic profile, profile width (internal): 100.5 mm, profile width (external): 105 mm, length: 95 mm, depth: 29.4 mm



Your advantages

- Aluminum extruded profile
- Variety of connection technology
- Can be mounted on the DIN rail
- Available in lengths from 42.5 mm ... 990 mm, can be cut to any length
- Available in overall widths of 75 mm and 105 mm
- EMC protection

Commercial data

Item number	2200937
Packing unit	1 pc
Minimum order quantity	1 pc
Sales key	AC14
Product key	ACHDFA
GTIN	4046356716468
Weight per piece (including packing)	115.5 g
Weight per piece (excluding packing)	112.4 g
Customs tariff number	76042990
Country of origin	DE

UM-ALU 4-100,5 PROFILE 95 - Profile

2200937

<https://www.phoenixcontact.com/us/products/2200937>

Technical data

Product properties

Product type	Component housing lower part
Housing type	Press-drawn section housings
Housing type	Extruded profile housings
Housing series	UM-ALU
Product family	UM-ALU 4-100,5
Ventilation openings present	no

Dimensions

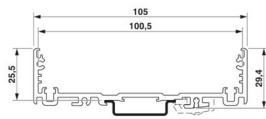
Dimensional drawing	
Depth	29.4 mm
Depth from top edge of DIN rail	25.5 mm
Length	95 mm

External dimensions

Profile width (external)	105 mm
--------------------------	--------

Internal dimensions

Profile width (internal)	100.5 mm
--------------------------	----------

PCB design

PCB thickness	1.44 mm ... 2 mm
---------------	------------------

Material specifications

Color (Profile)	aluminum color
Material Profile	Aluminum (anodized)
Surface characteristics	anodized

Environmental and real-life conditions

Ambient conditions

Max. IP code to attain	IP40
Ambient temperature (operation)	-40 °C ... 105 °C (depending on power dissipation)
Ambient temperature (storage/transport)	-40 °C ... 55 °C
Ambient temperature (assembly)	-5 °C ... 100 °C

PCB data

Number of PCB holders	3
Type of PCB mount	Slot

UM-ALU 4-100,5 PROFILE 95 - Profile



2200937

<https://www.phoenixcontact.com/us/products/2200937>

PCB surface	8551 mm ² ... 9332 mm ² (TOP in conjunction with side elements COVER...AL)
	9086 mm ² ... 9332 mm ² (BOTTOM in conjunction with side elements COVER...AL)
	8551 mm ² ... 9645 mm ² (TOP in conjunction with side elements COVER...PA)
	9124 mm ² ... 9645 mm ² (BOTTOM in conjunction with side elements COVER...PA)
Thickness of the PCB	1.44 mm ... 2 mm

Mounting

Mounting type	Screw mounting
Mounting position	parallel to the DIN rail

Packaging specifications

Type of packaging	packed in cardboard
Outer packaging type	Carton

UM-ALU 4-100,5 PROFILE 95 - Profile



2200937

<https://www.phoenixcontact.com/us/products/2200937>

Drawings

Dimensional drawing



UM-ALU 4-100,5 PROFILE 95 - Profile

2200937

<https://www.phoenixcontact.com/us/products/2200937>



Dimensional drawing



UM-ALU 4-100,5 PROFILE 95 - Profile



2200937

<https://www.phoenixcontact.com/us/products/2200937>

Classifications

ECLASS

ECLASS-13.0	27190601
ECLASS-15.0	27190601

ETIM

ETIM 10.0	EC002779
-----------	----------

UNSPSC

UNSPSC 21.0	31261500
-------------	----------

UM-ALU 4-100,5 PROFILE 95 - Profile



2200937

<https://www.phoenixcontact.com/us/products/2200937>

Environmental product compliance

EU RoHS

Fulfills EU RoHS substance requirements	Yes, No exemptions
---	--------------------

China RoHS

Environment friendly use period (EFUP)	EFUP-E
	No hazardous substances above the limits

EU REACH SVHC

REACH candidate substance (CAS No.)	No substance above 0.1 wt%
-------------------------------------	----------------------------

Phoenix Contact 2026 © - all rights reserved
<https://www.phoenixcontact.com>

Phoenix Contact USA
586 Fulling Mill Road
Middletown, PA 17057, United States
(+717) 944-1300
info@phoenixcon.com