

EH 90 F-B/ABS GY7035 - Mounting base housing



2200663

<https://www.phoenixcontact.com/us/products/2200663>

Please be informed that the data shown in this PDF document is generated from our online catalog. Please find the complete data in the user documentation. Our general terms of use for downloads are valid.



DIN rail housing, Lower housing part with base latch, flat design, without vents, width: 90.1 mm, height: 75 mm, depth: 30.3 mm, color: light gray (similar RAL 7035), cross connection: without bus connector, number of positions cross connector: not relevant

Your advantages

- DIN rail or panel mounting for application-specific device attachment
- Easy design-in, thanks to variable housing form factor
- Complete flexibility, thanks to PCBs with horizontal, frontal, and orthogonal orientation to the front of the device
- Three cover versions for individual PCB connections
- Integration of a wide variety of PCB connection technologies for a functional device design

Commercial data

Item number	2200663
Packing unit	10 pc
Minimum order quantity	10 pc
Sales key	AC12
Product key	ACHCHB
GTIN	4046356911122
Weight per piece (including packing)	32.48 g
Weight per piece (excluding packing)	32 g
Customs tariff number	84879090
Country of origin	IN

EH 90 F-B/ABS GY7035 - Mounting base housing

2200663

<https://www.phoenixcontact.com/us/products/2200663>

Technical data

Notes

Assembly note	Please observe the application note in the download area.
---------------	---

Product properties

Product type	Lower housing part
Housing type	DIN rail housing
Housing type	Basic housing
Housing series	EH
Product family	EH..F..ABS..
Type	Lower housing parts without vents, housing cover necessary to complete the module
Max. number of positions	0)
Ventilation openings present	no

Dimensions

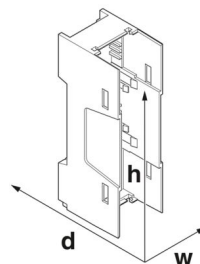
Dimensional drawing	
Width	90.1 mm
Height	75 mm
Depth	30.3 mm
Depth from top edge of DIN rail to support point on upper part	26 mm

PCB design

PCB thickness	1.4 mm ... 1.8 mm
---------------	-------------------

Material specifications

Color (Housing)	light gray (RAL 7035)
Material	ABS
Flammability rating according to UL 94	HB
Surface characteristics	untreated

Environmental and real-life conditions

Vibration test

Specification	IEC 60068-2-6:2007-12
Frequency	10 - 150 - 10 Hz
Sweep speed	1 octave/min

EH 90 F-B/ABS GY7035 - Mounting base housing



2200663

<https://www.phoenixcontact.com/us/products/2200663>

Amplitude	0.15 mm (10 Hz ... 58.1 Hz)
Acceleration	2g (58.1 Hz ... 150 Hz)
Test duration per axis	2.5 h
Test directions	X-, Y- and Z-axis

Glow-wire test

Specification	IEC 60695-2-11:2014-02
Temperature	850 °C
Time of exposure	30 s

Thermal stability / ball thrust test

Specification	IEC 60695-10-2:2014-02
Temperature	80 °C
Test duration	1 h
Force	20 N

Mechanical strength / tumbling barrel

Specification	IEC 60998-1:2002-12
Height of fall	50 cm
Frequency	10

Shocks

Specification	IEC 60068-2-27:2008-02
Pulse shape	Half-sine
Acceleration	15g
Shock duration	11 ms
Number of shocks per direction	3
Test directions	X-, Y- and Z-axis (pos. and neg.)

Degree of protection (IP code)

Specification	IEC 60529:1989-11 + AMD 1:1999-11 + AMD 2:2013-08
---------------	---

Ambient conditions

Max. IP code to attain	IP20
Ambient temperature (operation)	-40 °C ... 80 °C (depending on power dissipation)
Ambient temperature (storage/transport)	-40 °C ... 55 °C
Ambient temperature (assembly)	-5 °C ... 80 °C
Relative humidity (storage/transport)	95 %

PCB data

Type of PCB mount	Latching
Thickness of the PCB	1.4 mm ... 1.8 mm

Mounting

Mounting type	DIN rail mounting/panel mounting (with optional base latch)
---------------	---

Packaging specifications

EH 90 F-B/ABS GY7035 - Mounting base housing



2200663

<https://www.phoenixcontact.com/us/products/2200663>

Type of packaging	packed in cardboard
Outer packaging type	Carton

Drawings

Dimensional drawing



Schematic figure for illustrating the item dimensions. The figure is not of the desired product. For further details, refer to the product drawings in the "Downloads" tab.

EH 90 F-B/ABS GY7035 - Mounting base housing



2200663

<https://www.phoenixcontact.com/us/products/2200663>

Approvals

To download certificates, visit the product detail page: <https://www.phoenixcontact.com/us/products/2200663>



UL Recognized

Approval ID: E240868

EH 90 F-B/ABS GY7035 - Mounting base housing



2200663

<https://www.phoenixcontact.com/us/products/2200663>

Classifications

ECLASS

ECLASS-13.0	27190601
ECLASS-15.0	27190601

ETIM

ETIM 9.0	EC002779
----------	----------

UNSPSC

UNSPSC 21.0	31261500
-------------	----------

EH 90 F-B/ABS GY7035 - Mounting base housing



2200663

<https://www.phoenixcontact.com/us/products/2200663>

Environmental product compliance

EU RoHS

Fulfills EU RoHS substance requirements	Yes, No exemptions
---	--------------------

China RoHS

Environment friendly use period (EFUP)	EFUP-E
	No hazardous substances above the limits

EU REACH SVHC

REACH candidate substance (CAS No.)	No substance above 0.1 wt%
-------------------------------------	----------------------------

Phoenix Contact 2026 © - all rights reserved
<https://www.phoenixcontact.com>

Phoenix Contact USA
586 Fulling Mill Road
Middletown, PA 17057, United States
(+717) 944-1300
info@phoenixcon.com