

PC 6-16/ 6-G1-10,16 - PCB header

1998975

<https://www.phoenixcontact.com/us/products/1998975>

Please be informed that the data shown in this PDF document is generated from our online catalog. Please find the complete data in the user documentation. Our general terms of use for downloads are valid.

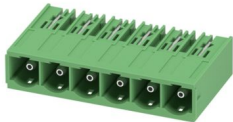

PCB headers, nominal cross section: 16 mm², color: green, nominal current: 76 A (41 A in combination with PC 6 plug), rated voltage (III/2): 1000 V, contact surface: Ag, contact connection type: Pin, number of potentials: 6, number of rows: 1, number of positions: 6, number of connections: 6, product range: PC 6-16/...-G1, pitch: 10.16 mm, mounting: Wave soldering, pin layout: Linear pinning, solder pin [P]: 4 mm, number of solder pins per potential: 3, plug-in system: COMBICON PC 16, Pin connector pattern alignment: Standard, locking: without, mounting method: without, type of packaging: packed in cardboard

Your advantages

- Well-known mounting principle allows worldwide use
- Maximum flexibility when it comes to device design – one header for connectors with different connection technologies

Commercial data

Item number	1998975
Packing unit	50 pc
Minimum order quantity	50 pc
Sales key	AA05
Product key	AAESBA
GTIN	4046356038478
Weight per piece (including packing)	24.7 g
Weight per piece (excluding packing)	23.344 g
Customs tariff number	85366930
Country of origin	PL

Technical data

Product properties

Product type	PCB headers
Product family	PC 6-16/...-G1
Product line	COMBICON Connectors XL
Type	Headers
Number of positions	6
Pitch	10.16 mm
Number of connections	6
Number of rows	1
Number of potentials	6
Mounting type	without
Pin layout	Linear pinning
Solder pins per potential	3

Electrical properties

Properties

Nominal current I_N	76 A (41 A in combination with PC 6 plug)
Nominal voltage U_N	1000 V
Contact resistance	0.22 mΩ
Rated voltage (III/3)	1000 V
Rated surge voltage (III/3)	8 kV
Rated voltage (III/2)	1000 V
Rated surge voltage (III/2)	8 kV
Rated voltage (II/2)	1000 V
Rated surge voltage (II/2)	6 kV

Mounting

Mounting type	Wave soldering
Pin layout	Linear pinning

Material specifications

Material data - contact

Note	WEEE/RoHS-compliant, free of whiskers according to IEC 60068-2-82/JEDEC JESD 201
Contact material	Cu alloy
Surface characteristics	Electroplated silver
Metal surface contact area (top layer)	Silver (4 μm - 8 μm Ag)
Metal surface contact area (middle layer)	Nickel (2 μm - 4 μm Ni)
Metal surface soldering area (top layer)	Silver (4 μm - 8 μm Ag)
Metal surface soldering area (middle layer)	Nickel (2 μm - 4 μm Ni)

PC 6-16/ 6-G1-10,16 - PCB header

1998975

<https://www.phoenixcontact.com/us/products/1998975>

Material data - housing

Color (Housing)	green (6021)
Insulating material	PA
Insulating material group	I
CTI according to IEC 60112	600
Flammability rating according to UL 94	V0
Glow wire flammability index GWFI according to EN 60695-2-12	850
Glow wire ignition temperature GWIT according to EN 60695-2-13	775
Temperature for the ball pressure test according to EN 60695-10-2	125 °C

Notes

Notes on operation	In accordance with IEC 61984, COMBICON connectors have no switching power (COC). During designated use, they must not be plugged in or disconnected when carrying voltage or under load.
--------------------	--

Dimensions

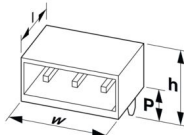
Dimensional drawing	
Pitch	10.16 mm
Width [w]	64 mm
Height [h]	17.4 mm
Length [l]	34 mm
Installed height	13.4 mm
Solder pin length [P]	4 mm
Pin dimensions	1 x 1.2 mm

PCB design

Pin spacing	10.16 mm
Hole diameter	1.7 mm

Mechanical tests

Visual inspection

Specification	IEC 60512-1-1:2002-02
Result	Test passed

Dimension check

Specification	IEC 60512-1-2:2002-02
Result	Test passed

Resistance of inscriptions

PC 6-16/ 6-G1-10,16 - PCB header



1998975

<https://www.phoenixcontact.com/us/products/1998975>

Specification	IEC 60068-2-70:1995-12
Result	Test passed

Polarization and coding

Specification	IEC 60512-13-5:2006-02
Result	Test passed

Contact holder in insert

Specification	IEC 60512-15-1:2008-05
Contact holder in insert Requirements >20 N	Test passed

Insertion and withdrawal forces

Specification	IEC 60512-13-2:2006-02
Result	Test passed
No. of cycles	50
Insertion strength per pos. approx.	17 N
Withdraw strength per pos. approx.	17 N

Electrical tests

Thermal test | Test group C

Specification	IEC 60512-5-1:2002-02
Tested number of positions	9

Insulation resistance

Specification	IEC 60512-3-1:2002-02
Insulation resistance, neighboring positions	> 5 MΩ

Air clearances and creepage distances |

Specification	IEC 60664-1:2007-04
Insulating material group	I
Comparative tracking index (IEC 60112)	CTI 600
Rated insulation voltage (III/3)	1000 V
Rated surge voltage (III/3)	8 kV
minimum clearance value - non-homogenous field (III/3)	8 mm
minimum creepage distance (III/3)	12.5 mm
Rated insulation voltage (III/2)	1000 V
Rated surge voltage (III/2)	8 kV
minimum clearance value - non-homogenous field (III/2)	8 mm
minimum creepage distance (III/2)	8 mm
Rated insulation voltage (II/2)	1000 V
Rated surge voltage (II/2)	6 kV
minimum clearance value - non-homogenous field (II/2)	5.5 mm
minimum creepage distance (II/2)	5.5 mm

Environmental and real-life conditions

PC 6-16/ 6-G1-10,16 - PCB header



1998975

<https://www.phoenixcontact.com/us/products/1998975>

Durability test

Specification	IEC 60512-9-1:2010-03
Impulse withstand voltage at sea level	9.8 kV
Contact resistance R ₁	0.22 mΩ
Contact resistance R ₂	0.24 mΩ
Insertion/withdrawal cycles	50
Insulation resistance, neighboring positions	> 5 MΩ

Climatic test

Specification	ISO 6988:1985-02
Corrosive stress	0.2 dm ³ SO ₂ on 300 dm ³ /40 °C/1 cycle
Thermal stress	100 °C/168 h
Power-frequency withstand voltage	4.26 kV

Vibration test

Specification	IEC 60068-2-6:2007-12
Frequency	10 - 150 - 10 Hz
Sweep speed	1 octave/min
Amplitude	0.35 mm (10 Hz ... 60.1 Hz)
Acceleration	5g (60.1 Hz ... 150 Hz)
Test duration per axis	2.5 h
Test directions	X-, Y- and Z-axis

Ambient conditions

Ambient temperature (storage/transport)	-40 °C ... 70 °C
Relative humidity (storage/transport)	30 % ... 70 %
Ambient temperature (assembly)	-5 °C ... 100 °C
Ambient temperature (operation)	-40 °C ... 100 °C (dependent on the derating curve)

Packaging specifications

Type of packaging	packed in cardboard
-------------------	---------------------

Drawings

Dimensional drawing

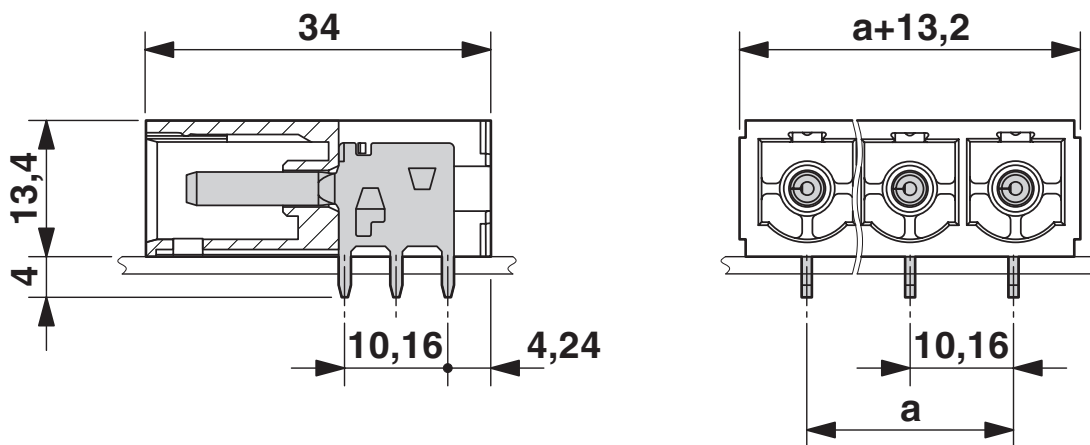

Diagram

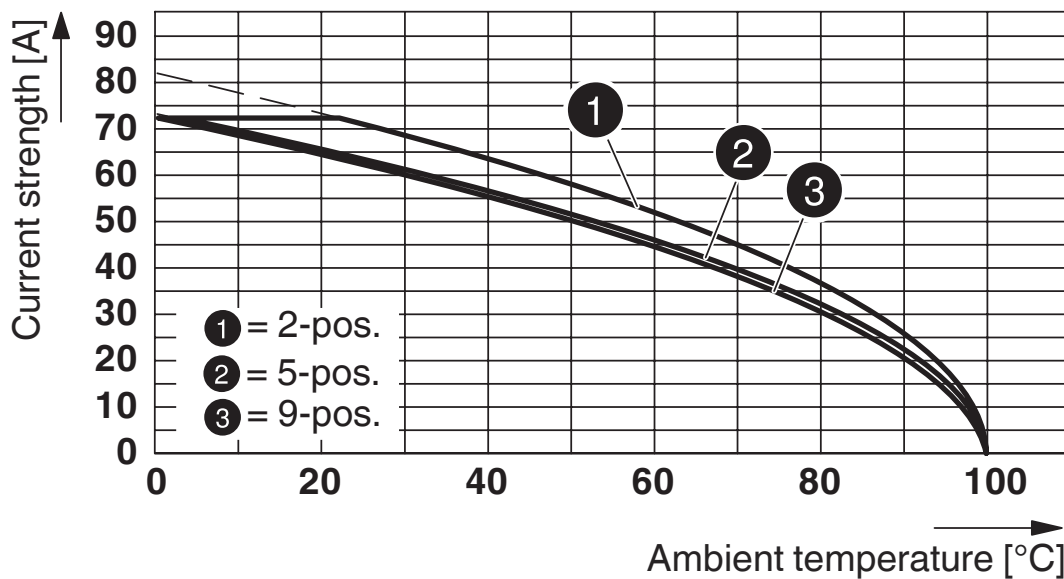

Type: PC 16/...-ST-10,16 with PC 6-16/...-G1-10,16

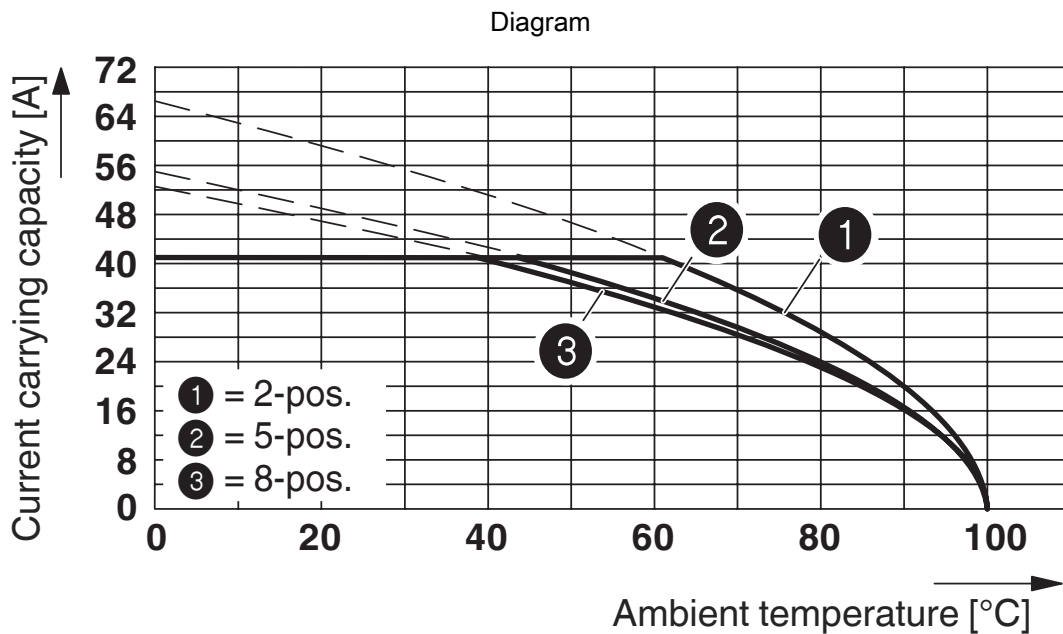

Derating curve for: PC 6/...-ST-10,16 with PC 6-16/...-G1-10,16

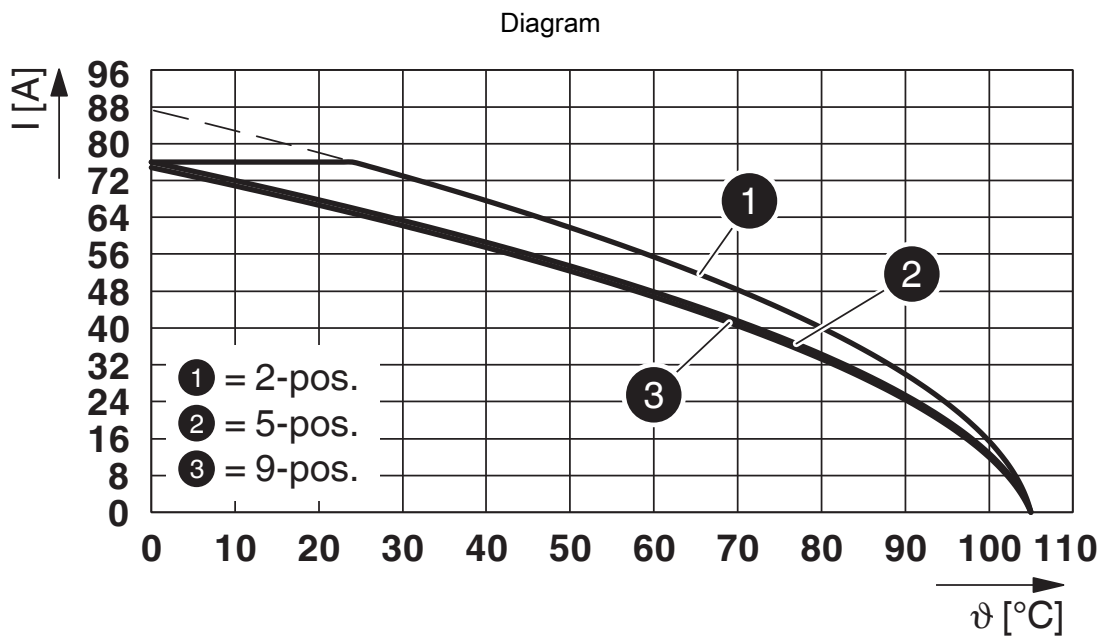

Type: SPC 16/...-ST-10,16 with PC 6-16/...-G1-10,16

PC 6-16/ 6-G1-10,16 - PCB header

1998975

<https://www.phoenixcontact.com/us/products/1998975>



Drilling plan/solder pad geometry

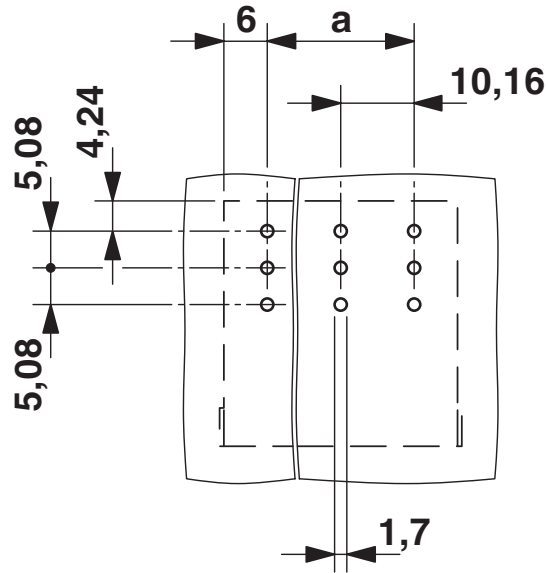

PC 6-16/ 6-G1-10,16 - PCB header





1998975

<https://www.phoenixcontact.com/us/products/1998975>

Approvals

To download certificates, visit the product detail page: <https://www.phoenixcontact.com/us/products/1998975>

 cULus Recognized Approval ID: E60425-20040202				
	Nominal voltage U_N	Nominal current I_N	Cross section AWG	Cross section mm^2
B	300 V	66 A	-	-
C	300 V	66 A	-	-
D	600 V	5 A	-	-

 VDE approval of drawings Approval ID: 40055586				
	Nominal voltage U_N	Nominal current I_N	Cross section AWG	Cross section mm^2
keine	1000 V	76 A	-	-

PC 6-16/ 6-G1-10,16 - PCB header



1998975

<https://www.phoenixcontact.com/us/products/1998975>

Classifications

ECLASS

ECLASS-13.0	27460201
ECLASS-15.0	27460201

ETIM

ETIM 10.0	EC002637
-----------	----------

UNSPSC

UNSPSC 21.0	39121400
-------------	----------

1998975

<https://www.phoenixcontact.com/us/products/1998975>

Environmental product compliance

EU RoHS

Fulfills EU RoHS substance requirements	Yes, No exemptions
---	--------------------

China RoHS

Environment friendly use period (EFUP)	EFUP-E
	No hazardous substances above the limits

EU REACH SVHC

REACH candidate substance (CAS No.)	No substance above 0.1 wt%
-------------------------------------	----------------------------

EF3.1 Climate Change

CO2e kg	0.071 kg CO2e
---------	---------------

Phoenix Contact 2026 © - all rights reserved
<https://www.phoenixcontact.com>

Phoenix Contact USA
586 Fulling Mill Road
Middletown, PA 17057, United States
(+717) 944-1300
info@phoenixcon.com