

# IPC 16/ 8-STGF-10,16 - PCB connector

1975875

<https://www.phoenixcontact.com/us/products/1975875>

Please be informed that the data shown in this PDF document is generated from our online catalog. Please find the complete data in the user documentation. Our general terms of use for downloads are valid.



PCB connector, nominal cross section: 16 mm<sup>2</sup>, color: green, nominal current: 76 A, rated voltage (III/2): 1000 V, contact surface: Ag, contact connection type: Pin, number of potentials: 8, number of rows: 1, number of positions: 8, number of connections: 8, product range: IPC 16/-STGF, pitch: 10.16 mm, connection method: Screw connection with tension sleeve, screw head form: L Slotted, conductor/PCB connection direction: 0 °, locking clip: - without locking clip, plug-in system: COMBICON PC 16, locking: Screw locking mechanism for cable-to-cable connection, mounting method: Threaded flange, type of packaging: packed in cardboard

## Your advantages

- Well-known connection principle allows worldwide use
- Low temperature rise, thanks to maximum contact force
- Allows connection of two conductors
- Inverted connector with pin contacts for touch-proof device outputs or free-hanging cable/cable connections
- Screwable flange for superior mechanical stability

## Commercial data

Item number	1975875
Packing unit	25 pc
Minimum order quantity	50 pc
Note	Made to order (non-returnable)
Sales key	AA05
Product key	AAEABD
GTIN	4017918972011
Weight per piece (including packing)	76.8 g
Weight per piece (excluding packing)	75.114 g
Customs tariff number	85366990
Country of origin	PL

# IPC 16/ 8-STGF-10,16 - PCB connector



1975875

<https://www.phoenixcontact.com/us/products/1975875>

## Technical data

### Product properties

Product type	PCB connector
Product family	IPC 16/..-STGF
Product line	COMBICON Connectors XL
Type	Inverted
Number of positions	8
Pitch	10.16 mm
Number of connections	8
Number of rows	1
Number of potentials	8
Mounting type	Threaded flange

### Electrical properties

#### Properties

Nominal current $I_N$	76 A
Nominal voltage $U_N$	1000 V
Contact resistance	0.3 mΩ
Rated voltage (III/3)	1000 V
Rated surge voltage (III/3)	8 kV
Rated voltage (III/2)	1000 V
Rated surge voltage (III/2)	8 kV
Rated voltage (II/2)	1000 V
Rated surge voltage (II/2)	6 kV

### Connection data

#### Connection technology

Type	Inverted
Connector system	COMBICON PC 16
Nominal cross section	16 mm <sup>2</sup>
Contact connection type	Pin

#### Interlock

Locking type	Screw locking mechanism for cable-to-cable connection
Mounting type	Threaded flange
Tightening torque	0.3 Nm

#### Conductor connection

Connection method	Screw connection with tension sleeve
Conductor/PCB connection direction	0 °
Conductor cross-section rigid	0.75 mm <sup>2</sup> ... 16 mm <sup>2</sup>
Conductor cross-section flexible	0.75 mm <sup>2</sup> ... 16 mm <sup>2</sup>

# IPC 16/ 8-STGF-10,16 - PCB connector



1975875

<https://www.phoenixcontact.com/us/products/1975875>

Conductor cross-section AWG	18 ... 6
Conductor cross-section, flexible, with ferrule, without plastic sleeve	0.5 mm <sup>2</sup> ... 16 mm <sup>2</sup>
Conductor cross-section, flexible, with ferrule, with plastic sleeve	0.5 mm <sup>2</sup> ... 10 mm <sup>2</sup>
2 conductors with same cross section, rigid	0.75 mm <sup>2</sup> ... 6 mm <sup>2</sup>
2 conductors with same cross section, flexible	0.75 mm <sup>2</sup> ... 6 mm <sup>2</sup>
2 conductors with same cross section, flexible, with ferrule without plastic sleeve	0.5 mm <sup>2</sup> ... 4 mm <sup>2</sup>
2 conductors with the same cross section, flexible, with TWIN ferrule with plastic sleeve	0.5 mm <sup>2</sup> ... 6 mm <sup>2</sup>
Cylindrical gauge a x b / diameter	- / 5.4 mm
Stripping length	12 mm
Drive form screw head	Slotted (L)
Tightening torque	1.7 Nm ... 1.8 Nm

## Material specifications

### Material data - contact

Note	WEEE/RoHS-compliant, free of whiskers according to IEC 60068-2-82/JEDEC JESD 201
Contact material	Cu alloy
Surface characteristics	completely silver-plated
Metal surface terminal point (top layer)	Silver (4 µm - 8 µm Ag)
Metal surface contact area (top layer)	Silver (4 µm - 8 µm Ag)

### Material data - housing

Color (Housing)	green (6021)
Insulating material	PA
Insulating material group	I
CTI according to IEC 60112	600
Flammability rating according to UL 94	V0
Glow wire flammability index GWFI according to EN 60695-2-12	850
Glow wire ignition temperature GWIT according to EN 60695-2-13	775
Temperature for the ball pressure test according to EN 60695-10-2	125 °C

## Dimensions

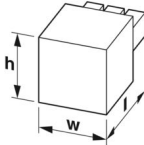
Dimensional drawing	
Pitch	10.16 mm
Width [w]	99.04 mm
Height [h]	27.75 mm

# IPC 16/ 8-STGF-10,16 - PCB connector



1975875

<https://www.phoenixcontact.com/us/products/1975875>

Length [l]	44.1 mm
------------	---------

## Mounting

### Flange

Tightening torque	0.3 Nm
-------------------	--------

## Notes

Notes on operation	In accordance with IEC 61984, COMBICON connectors have no switching power (COC). During designated use, they must not be plugged in or disconnected when carrying voltage or under load.
--------------------	--

## Mechanical tests

### Test for conductor damage and slackening

Specification	IEC 60999-1:1999-11
Result	Test passed

### Pull-out test

Specification	IEC 60999-1:1999-11
Conductor cross-section/conductor type/tractive force setpoint/actual value	0.75 mm <sup>2</sup> / solid / > 30 N
	0.75 mm <sup>2</sup> / flexible / > 30 N
	16 mm <sup>2</sup> / solid / > 100 N
	16 mm <sup>2</sup> / flexible / > 100 N

### Insertion and withdrawal forces

Specification	IEC 60512-13-2:2006-02
Result	Test passed
No. of cycles	50
Insertion strength per pos. approx.	12 N
Withdraw strength per pos. approx.	8 N

### Torque test

Specification	IEC 60999-1:1999-11
---------------	---------------------

### Resistance of inscriptions

Specification	IEC 60068-2-70:1995-12
Result	Test passed

### Polarization and coding

Specification	IEC 60512-13-5:2006-02
Result	Test passed

### Visual inspection

Specification	IEC 60512-1-1:2002-02
Result	Test passed

### Dimension check

Specification	IEC 60512-1-2:2002-02
---------------	-----------------------

# IPC 16/ 8-STGF-10,16 - PCB connector



1975875

<https://www.phoenixcontact.com/us/products/1975875>

Result	Test passed
--------	-------------

## Environmental and real-life conditions

### Durability test

Specification	IEC 60512-9-1:2010-03
Impulse withstand voltage at sea level	9.8 kV
Contact resistance $R_1$	0.3 m $\Omega$
Contact resistance $R_2$	0.3 m $\Omega$
Insertion/withdrawal cycles	50
Insulation resistance, neighboring positions	> 5 M $\Omega$

### Climatic test

Specification	ISO 6988:1985-02
Corrosive stress	0.2 dm <sup>3</sup> SO <sub>2</sub> on 300 dm <sup>3</sup> /40 °C/1 cycle
Thermal stress	100 °C/168 h
Power-frequency withstand voltage	4.26 kV

### Vibration test

Specification	IEC 60068-2-6:2007-12
Frequency	10 - 150 - 10 Hz
Sweep speed	1 octave/min
Amplitude	0.35 mm (10 Hz ... 60.1 Hz)
Acceleration	5g (60.1 Hz ... 150 Hz)
Test duration per axis	2.5 h
Test directions	X-, Y- and Z-axis

### Shocks

Specification	IEC 60068-2-27:2008-02
Pulse shape	Semi-sinusoidal
Acceleration	30g
Shock duration	18 ms
Test directions	X-, Y- and Z-axis (pos. and neg.)

### Railway application: Shocks

Acceleration	30g
Shock duration	18 ms
Test directions	X-, Y- and Z-axis (pos. and neg.)

### Ambient conditions

Ambient temperature (storage/transport)	-40 °C ... 70 °C
Relative humidity (storage/transport)	30 % ... 70 %
Ambient temperature (assembly)	-5 °C ... 100 °C
Ambient temperature (operation)	-40 °C ... 100 °C (dependent on the derating curve)

## Electrical tests

# IPC 16/ 8-STGF-10,16 - PCB connector



1975875

<https://www.phoenixcontact.com/us/products/1975875>

## Thermal test | Test group C

Specification	IEC 60512-5-1:2002-02
Tested number of positions	9

## Insulation resistance

Specification	IEC 60512-3-1:2002-02
Insulation resistance, neighboring positions	> 5 MΩ

## Air clearances and creepage distances |

Specification	IEC 60664-1:2007-04
Insulating material group	I
Comparative tracking index (IEC 60112)	CTI 600
Rated insulation voltage (III/3)	1000 V
Rated surge voltage (III/3)	8 kV
minimum clearance value - non-homogenous field (III/3)	8 mm
minimum creepage distance (III/3)	12.5 mm
Rated insulation voltage (III/2)	1000 V
Rated surge voltage (III/2)	8 kV
minimum clearance value - non-homogenous field (III/2)	8 mm
minimum creepage distance (III/2)	8 mm
Rated insulation voltage (II/2)	1000 V
Rated surge voltage (II/2)	6 kV
minimum clearance value - non-homogenous field (II/2)	5.5 mm
minimum creepage distance (II/2)	5.5 mm

## Packaging specifications

Type of packaging	packed in cardboard
-------------------	---------------------

Drawings

Dimensional drawing

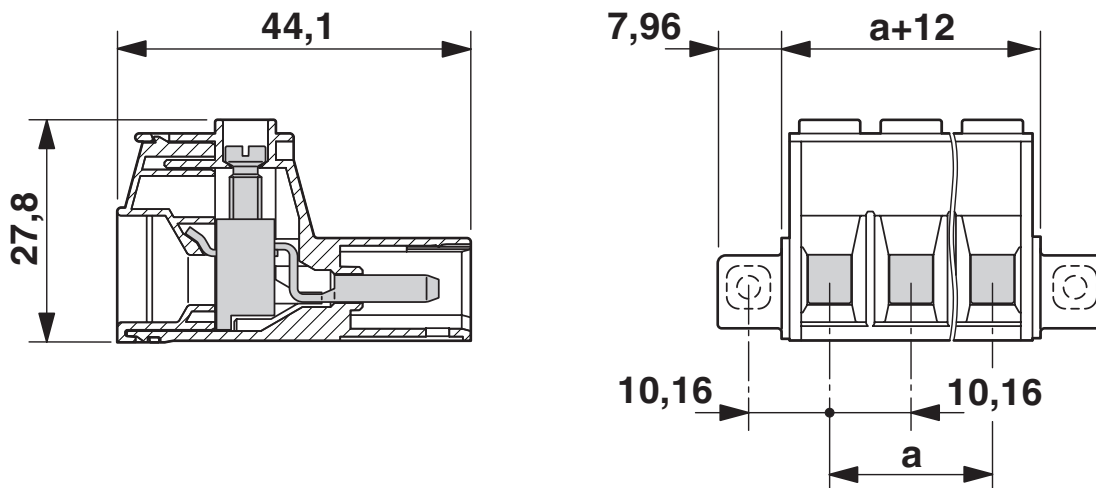

The figure shows the 3-pos. version

Diagram

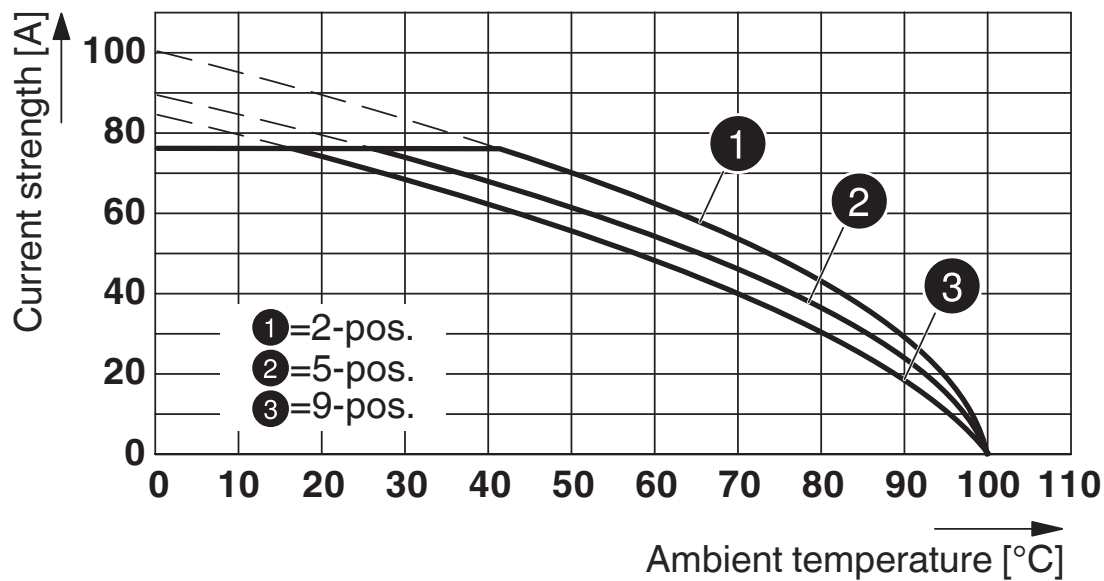

Type: PC 16/..-STF-10,16 with IPC 16/..-STGF-10,16

# IPC 16/ 8-STGF-10,16 - PCB connector



1975875

<https://www.phoenixcontact.com/us/products/1975875>

Diagram

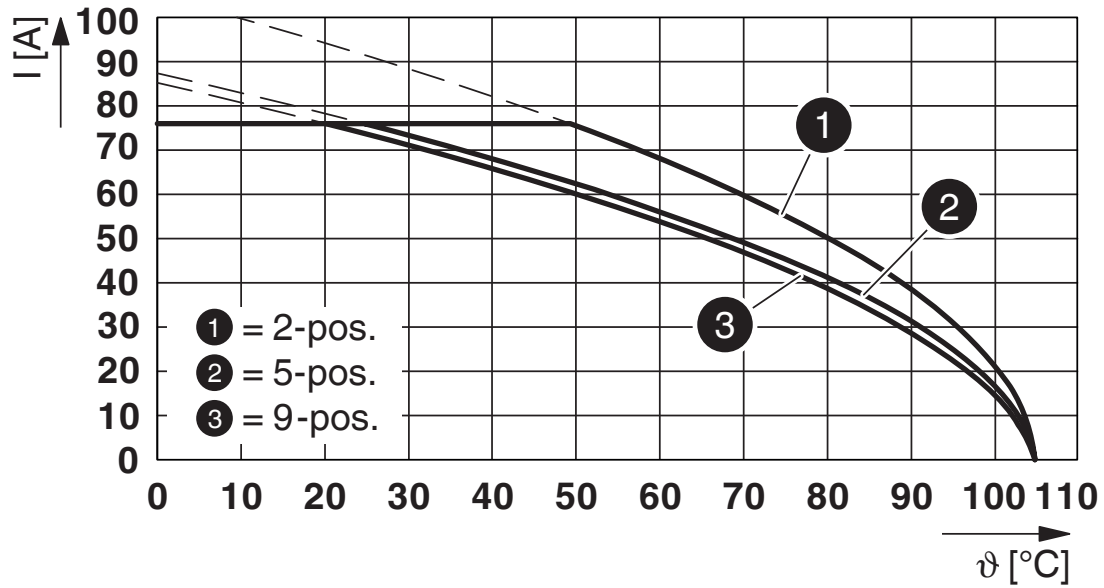

Type: SPC 16/...-STF-10,16 with IPC 16/...-STGF-10,16

# IPC 16/ 8-STGF-10,16 - PCB connector



1975875

<https://www.phoenixcontact.com/us/products/1975875>

## Approvals

To download certificates, visit the product detail page: <https://www.phoenixcontact.com/us/products/1975875>

 <b>cULus Recognized</b> Approval ID: E60425-20040202				
	Nominal voltage $U_N$	Nominal current $I_N$	Cross section AWG	Cross section $\text{mm}^2$
B	600 V	55 A	20 - 6	-
C	600 V	55 A	20 - 6	-

 <b>VDE approval of drawings</b> Approval ID: 40055586				
	Nominal voltage $U_N$	Nominal current $I_N$	Cross section AWG	Cross section $\text{mm}^2$
keine	1000 V	76 A	-	0.75 - 16

# IPC 16/ 8-STGF-10,16 - PCB connector



1975875

<https://www.phoenixcontact.com/us/products/1975875>

## Classifications

### ECLASS

ECLASS-13.0	27460202
ECLASS-15.0	27460202

### ETIM

ETIM 10.0	EC002638
-----------	----------

### UNSPSC

UNSPSC 21.0	39121400
-------------	----------

# IPC 16/ 8-STGF-10,16 - PCB connector



1975875

<https://www.phoenixcontact.com/us/products/1975875>

## Environmental product compliance

### EU RoHS

Fulfills EU RoHS substance requirements	Yes, No exemptions
---	--------------------

### China RoHS

Environment friendly use period (EFUP)	EFUP-E
	No hazardous substances above the limits

### EU REACH SVHC

REACH candidate substance (CAS No.)	No substance above 0.1 wt%
-------------------------------------	----------------------------

### EF3.1 Climate Change

CO2e kg	0.901 kg CO2e
---------	---------------

Phoenix Contact 2026 © - all rights reserved  
<https://www.phoenixcontact.com>

Phoenix Contact USA  
586 Fulling Mill Road  
Middletown, PA 17057, United States  
(+717) 944-1300  
[info@phoenixcon.com](mailto:info@phoenixcon.com)