

CCV 2,5/ 5-G-5,08 P26THRR56 - PCB header



1955552

<https://www.phoenixcontact.com/us/products/1955552>

Please be informed that the data shown in this PDF document is generated from our online catalog. Please find the complete data in the user documentation. Our general terms of use for downloads are valid.

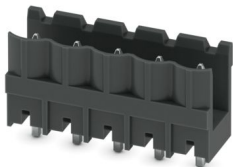

PCB headers, nominal cross section: 2.5 mm², color: black, nominal current: 12 A, rated voltage (III/2): 320 V, contact surface: Sn, contact connection type: Pin, number of potentials: 5, number of rows: 1, number of positions: 5, number of connections: 5, product range: CCV 2,5/...-G, pitch: 5.08 mm, mounting: THR soldering / wave soldering, pin layout: Linear pinning, solder pin [P]: 2.6 mm, number of solder pins per potential: 1, plug-in system: COMBICON MSTB 2,5, Pin connector pattern alignment: Standard, locking: without, mounting method: without, type of packaging: 56 mm wide tape, For user information and design recommendations for through-hole reflow technology, go to: Downloads

Your advantages

- Designed for integration into the SMT soldering process
- Vertical connection enables multi-row arrangement on the PCB
- Maximum flexibility when it comes to device design – one header for connectors with different connection technologies

Commercial data

Item number	1955552
Packing unit	140 pc
Minimum order quantity	140 pc
Note	Made to order (non-returnable)
Sales key	AA03
Product key	AACTBG
GTIN	4017918926311
Weight per piece (including packing)	5.9 g
Weight per piece (excluding packing)	5.463 g
Customs tariff number	85366930
Country of origin	DE

1955552

<https://www.phoenixcontact.com/us/products/1955552>

Technical data

Product properties

Product type	PCB headers
Product family	CCV 2,5/..-G
Product line	COMBICON Connectors M
Type	Component suitable for through hole reflow
Number of positions	5
Pitch	5.08 mm
Number of connections	5
Number of rows	1
Number of potentials	5
Mounting type	without
Pin layout	Linear pinning
Solder pins per potential	1

Electrical properties

Properties

Nominal current I_N	12 A
Nominal voltage U_N	320 V
Contact resistance	1.2 mΩ
Rated voltage (III/3)	250 V
Rated surge voltage (III/3)	4 kV
Rated voltage (III/2)	320 V
Rated surge voltage (III/2)	4 kV
Rated voltage (II/2)	400 V
Rated surge voltage (II/2)	4 kV

Mounting

Mounting type	THR soldering / wave soldering
Pin layout	Linear pinning

Processing notes

Process	Reflow/wave soldering
Moisture Sensitive Level	MSL 1
Classification temperature T_c	260 °C
Solder cycles in the reflow	3

Material specifications

Material data - contact

Note	WEEE/RoHS-compliant, free of whiskers according to IEC 60068-2-82/JEDEC JESD 201
Contact material	Cu alloy

CCV 2,5/ 5-G-5,08 P26THRR56 - PCB header



1955552

<https://www.phoenixcontact.com/us/products/1955552>

Surface characteristics	Tin-plated
Metal surface contact area (top layer)	Tin (3 µm - 5 µm Sn)
Metal surface contact area (middle layer)	Nickel (1.3 µm - 3 µm Ni)
Metal surface soldering area (top layer)	Tin (3 µm - 5 µm Sn)
Metal surface soldering area (middle layer)	Nickel (1.3 µm - 3 µm Ni)

Material data - housing

Color (Housing)	black (9005)
Insulating material	LCP
Insulating material group	IIIa
CTI according to IEC 60112	175
Flammability rating according to UL 94	V0

Notes

Details for soldering processes	Processing using reflow processes in compliance with IEC 60068-2-58 or DIN EN 61760-1 (latest version) Moisture Sensitive Level (MSL) = 1 according to IPC/JEDEC J-STD-020-C
---------------------------------	---

Dimensions

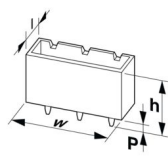
Dimensional drawing	
Pitch	5.08 mm
Width [w]	25 mm
Height [h]	14.6 mm
Length [l]	8.57 mm
Installed height	12 mm
Solder pin length [P]	2.6 mm
Pin dimensions	1 x 1 mm

PCB design

Hole diameter	1.6 mm
---------------	--------

Mechanical tests

Visual inspection

Specification	IEC 60512-1-1:2002-02
Result	Test passed

Dimension check

Specification	IEC 60512-1-2:2002-02
Result	Test passed

Resistance of inscriptions

1955552

<https://www.phoenixcontact.com/us/products/1955552>

Specification	IEC 60068-2-70:1995-12
Result	Test passed

Polarization and coding

Specification	IEC 60512-13-5:2006-02
Result	Test passed

Contact holder in insert

Specification	IEC 60512-15-1:2008-05
Contact holder in insert Requirements >20 N	Test passed

Insertion and withdrawal forces

Specification	IEC 60512-13-2:2006-02
Result	Test passed
No. of cycles	25
Insertion strength per pos. approx.	8 N
Withdraw strength per pos. approx.	6 N

Electrical tests

Thermal test | Test group C

Specification	IEC 60512-5-1:2002-02
Tested number of positions	12

Insulation resistance

Specification	IEC 60512-3-1:2002-02
Insulation resistance, neighboring positions	> 5 MΩ

Air clearances and creepage distances |

Specification	IEC 60664-1:2007-04
Insulating material group	IIIa
Comparative tracking index (IEC 60112)	CTI 175
Rated insulation voltage (III/3)	250 V
Rated surge voltage (III/3)	4 kV
minimum clearance value - non-homogenous field (III/3)	3 mm
minimum creepage distance (III/3)	4 mm
Rated insulation voltage (III/2)	320 V
Rated surge voltage (III/2)	4 kV
minimum clearance value - non-homogenous field (III/2)	3 mm
minimum creepage distance (III/2)	3.2 mm
Rated insulation voltage (II/2)	400 V
Rated surge voltage (II/2)	4 kV
minimum clearance value - non-homogenous field (II/2)	3 mm
minimum creepage distance (II/2)	4 mm

Environmental and real-life conditions

CCV 2,5/ 5-G-5,08 P26THRR56 - PCB header



1955552

<https://www.phoenixcontact.com/us/products/1955552>

Durability test

Specification	IEC 60512-9-1:2010-03
Impulse withstand voltage at sea level	4.8 kV
Contact resistance R_1	1.2 m Ω
Contact resistance R_2	1.2 m Ω
Insertion/withdrawal cycles	25
Insulation resistance, neighboring positions	> 5 M Ω

Climatic test

Specification	ISO 6988:1985-02
Corrosive stress	0.2 dm ³ SO ₂ on 300 dm ³ /40 °C/1 cycle
Thermal stress	100 °C/168 h
Power-frequency withstand voltage	2.21 kV

Vibration test

Specification	IEC 60068-2-6:2007-12
Frequency	10 - 150 - 10 Hz
Sweep speed	1 octave/min
Amplitude	0.35 mm (10 Hz ... 60.1 Hz)
Acceleration	5g (60.1 Hz ... 150 Hz)
Test duration per axis	2.5 h
Test directions	X-, Y- and Z-axis

Ambient conditions

Ambient temperature (storage/transport)	-40 °C ... 70 °C
Relative humidity (storage/transport)	30 % ... 70 %
Ambient temperature (assembly)	-5 °C ... 100 °C
Ambient temperature (operation)	-40 °C ... 100 °C (dependent on the derating curve)

Packaging specifications

Dimensional drawing	
Type of packaging	56 mm wide tape
[W] tape width	56 mm
[W2] coil overall dimension	≤ 62.4 mm
[A] coil diameter	≤ 330 mm
Outer packaging type	Transparent-Bag

Drawings

Diagram

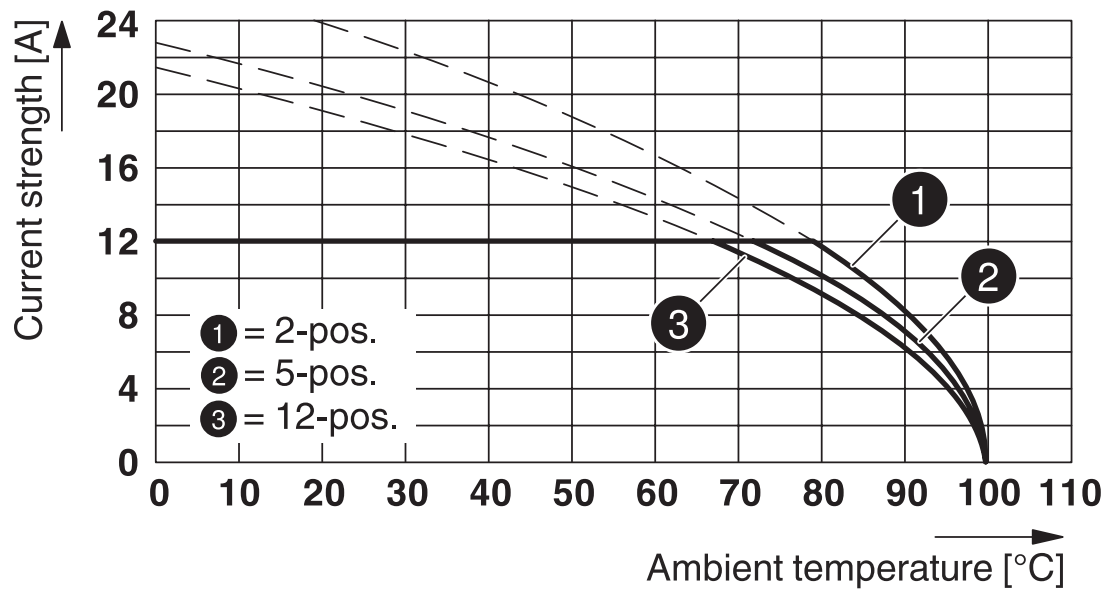

Type: MSTB 2,5/...-ST-5,08 with CCV 2,5/...-G-5,08 P26THR

Diagram

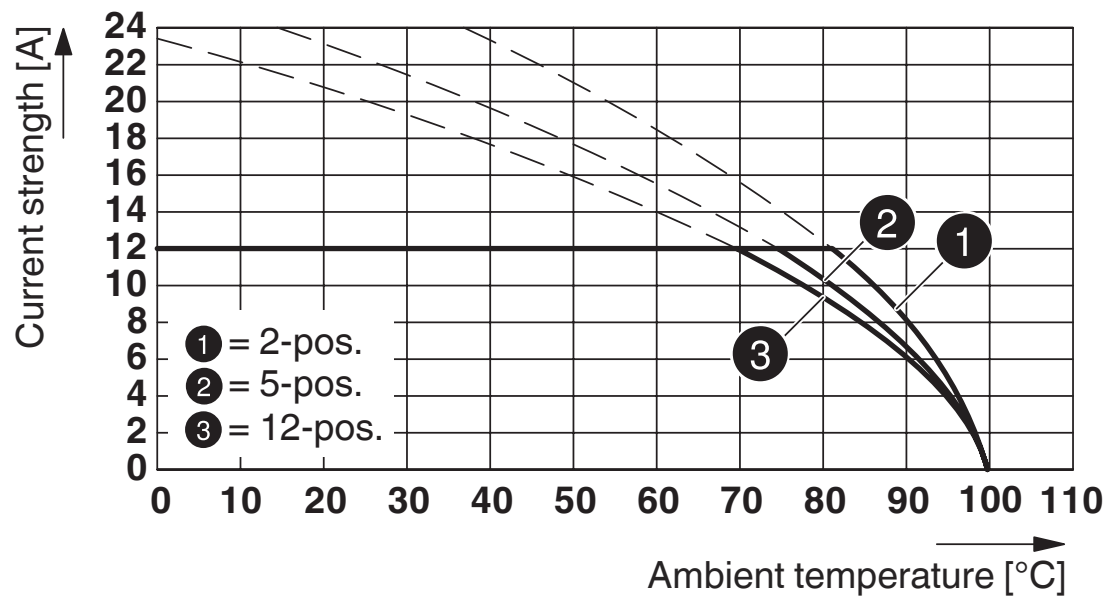

Type: MSTBP 2,5/...-ST-5,08 with CCV 2,5/...-G-5,08 P26THR

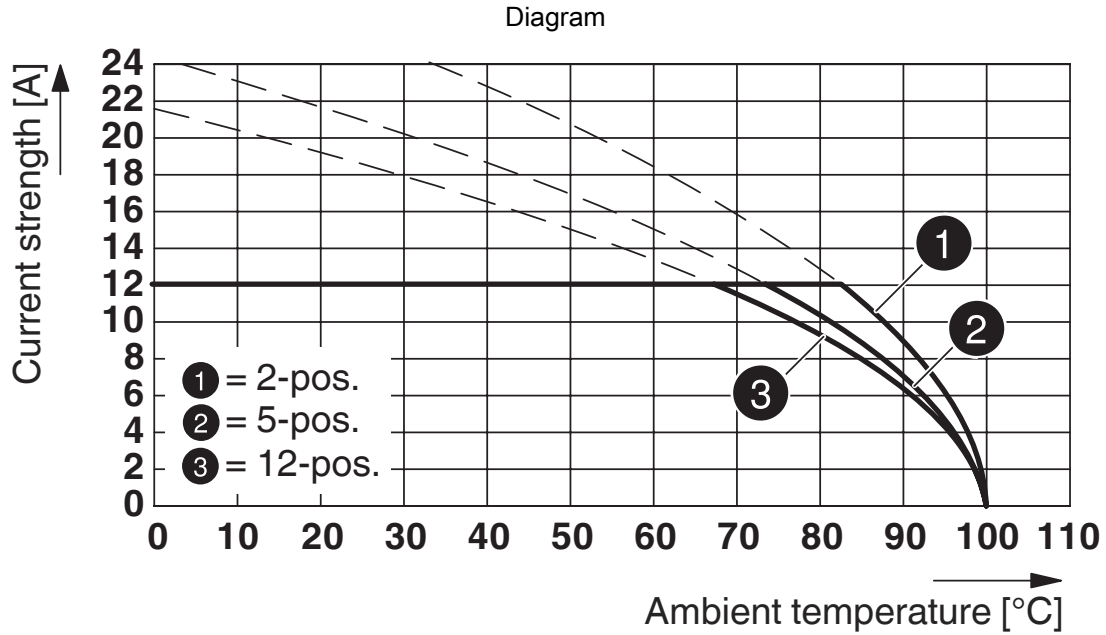

Type: MSTBT 2,5/...-ST-5,08 with CCV 2,5/...-G-5,08 P26THR

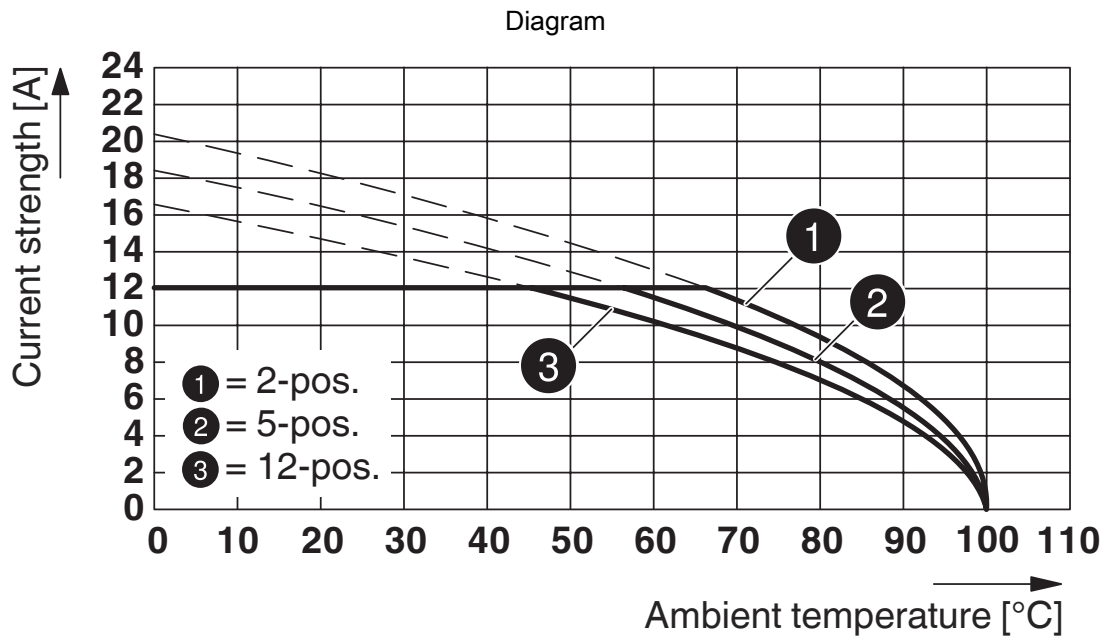

Type: SMSTB 2,5/...-ST-5,08 with CCV 2,5/...-G-5,08 P26THR

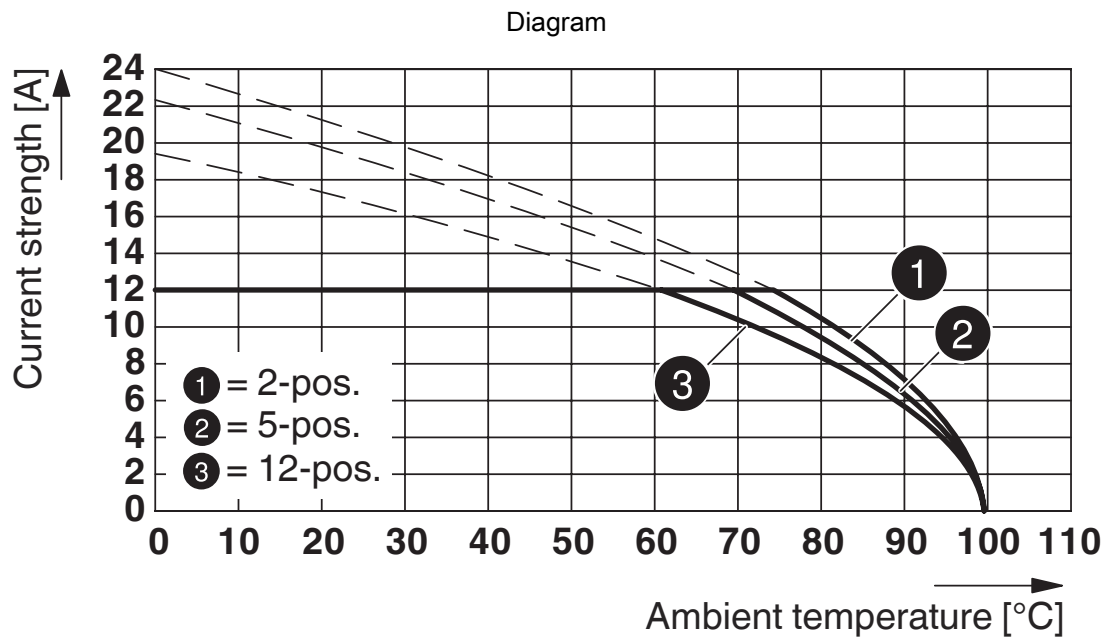

Type: FRONT-MSTB 2,5/...-ST-5,08 with CCV 2,5/...-G-5,08 P26THR

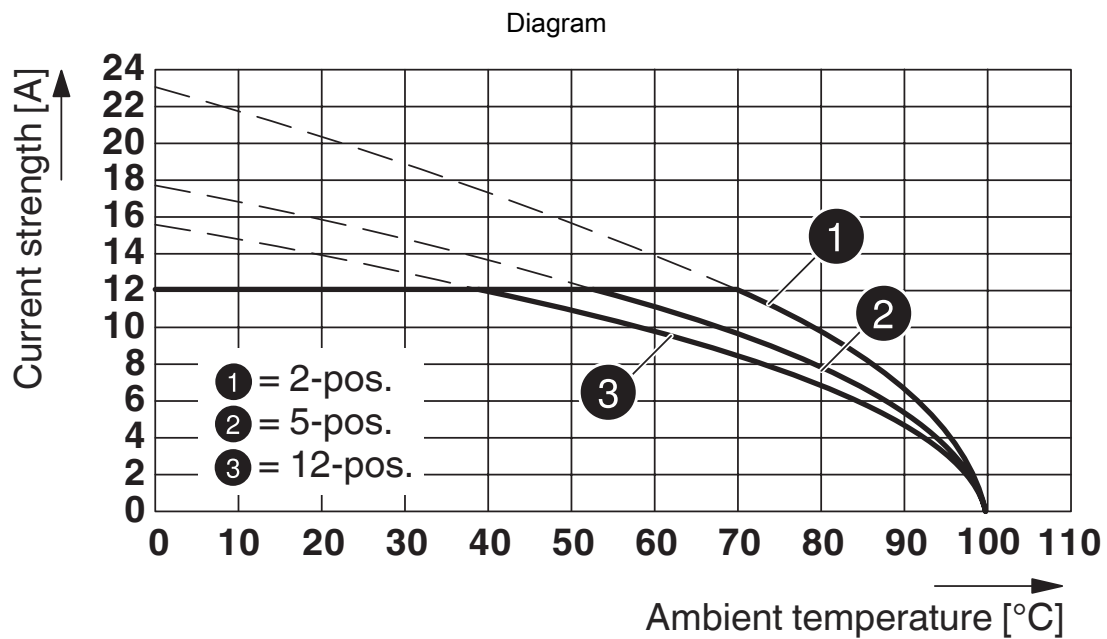

Type: MVSTBR 2,5/...-ST-5,08 with CCV 2,5/...-G-5,08 P26THR

1955552

<https://www.phoenixcontact.com/us/products/1955552>

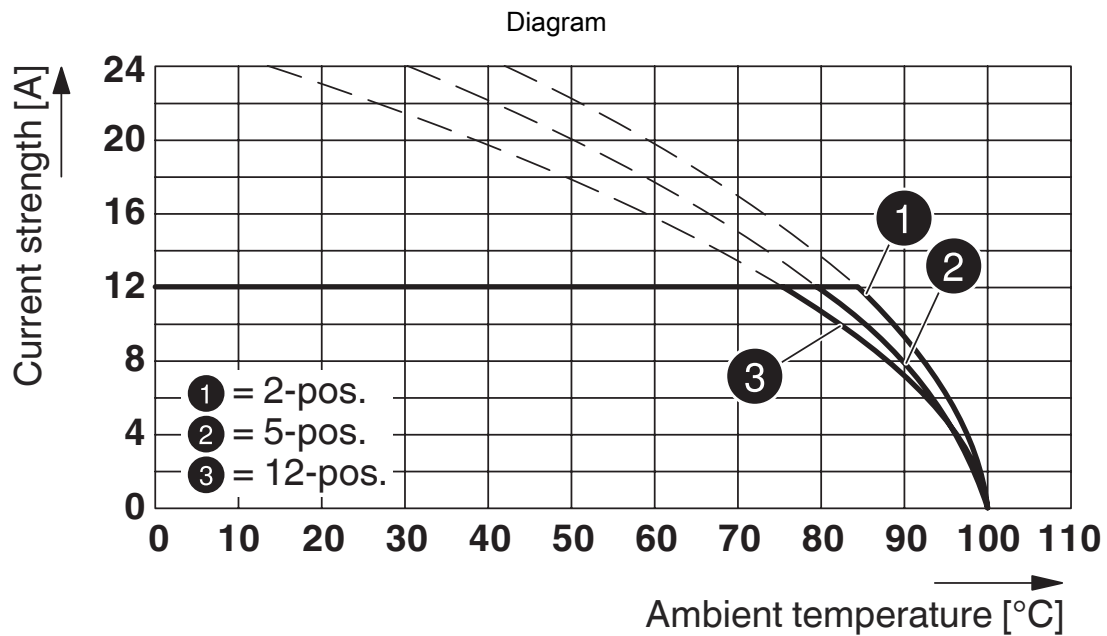

Type: FKC 2,5/...-ST-5,08 with CCV 2,5/...-G-5,08 P26THR

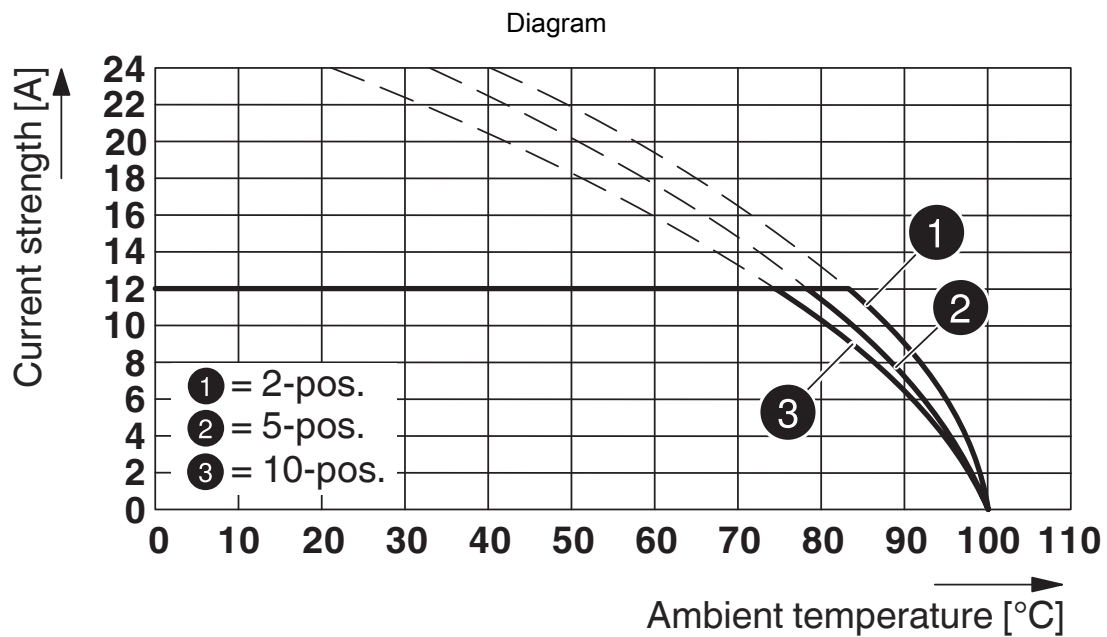

Type: TMSTBP 2,5/...-ST-5,08 with CCV 2,5/...-G-5,08 P26THR

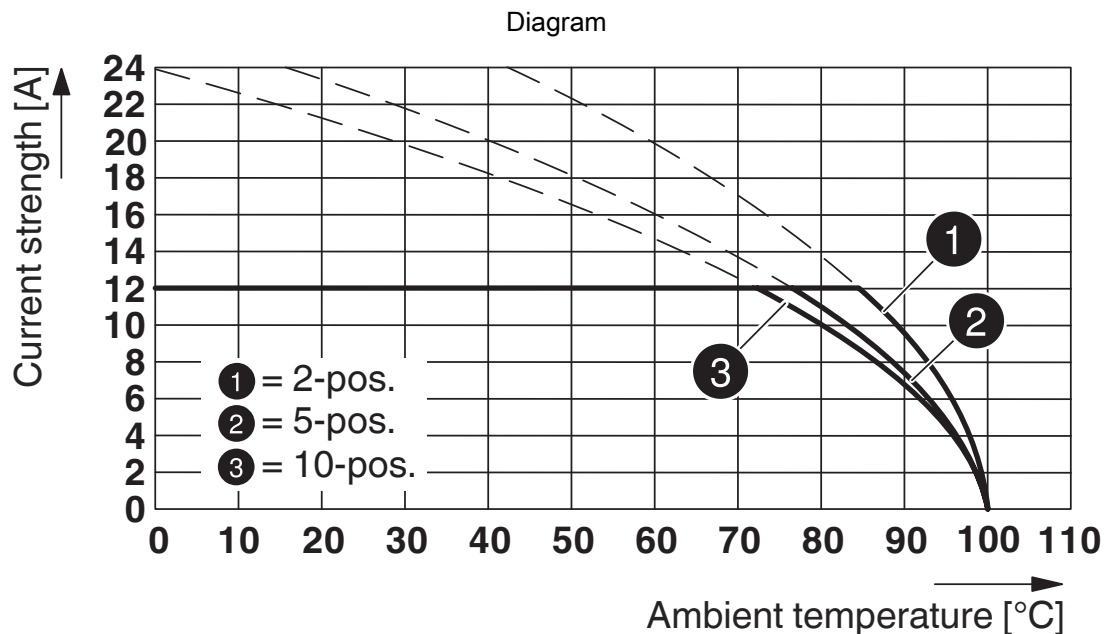

Type: TVMSTB 2,5/...-ST-5,08 with CCV 2,5/...-G-5,08 P26THR

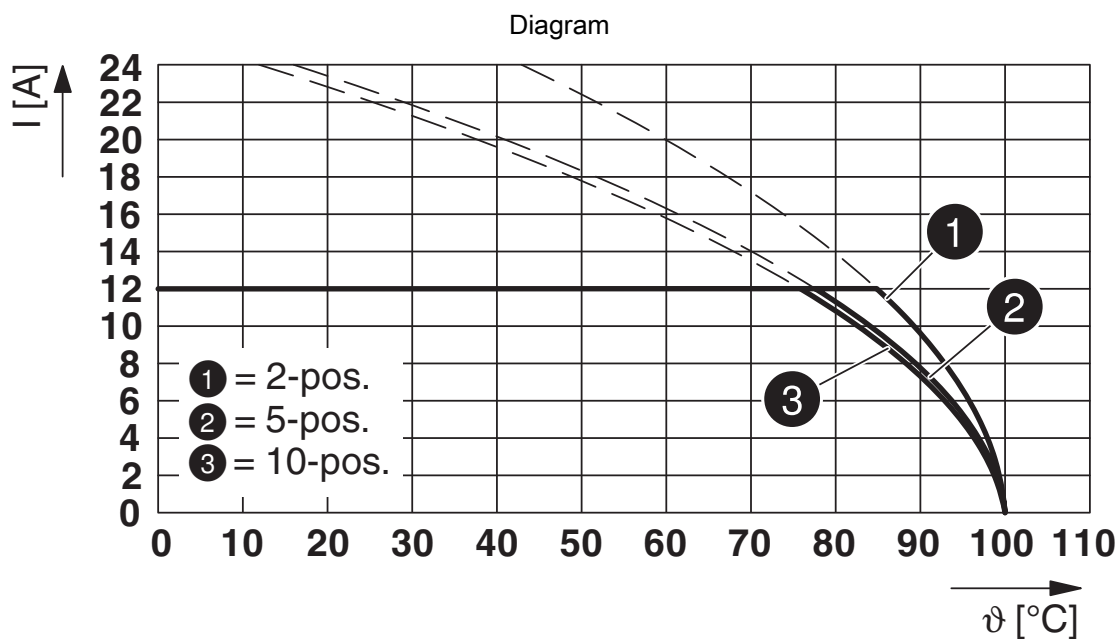

Type: TFKC 2,5/...-ST-5,08 with CCV 2,5/...-G-5,08 P...THR

1955552

<https://www.phoenixcontact.com/us/products/1955552>

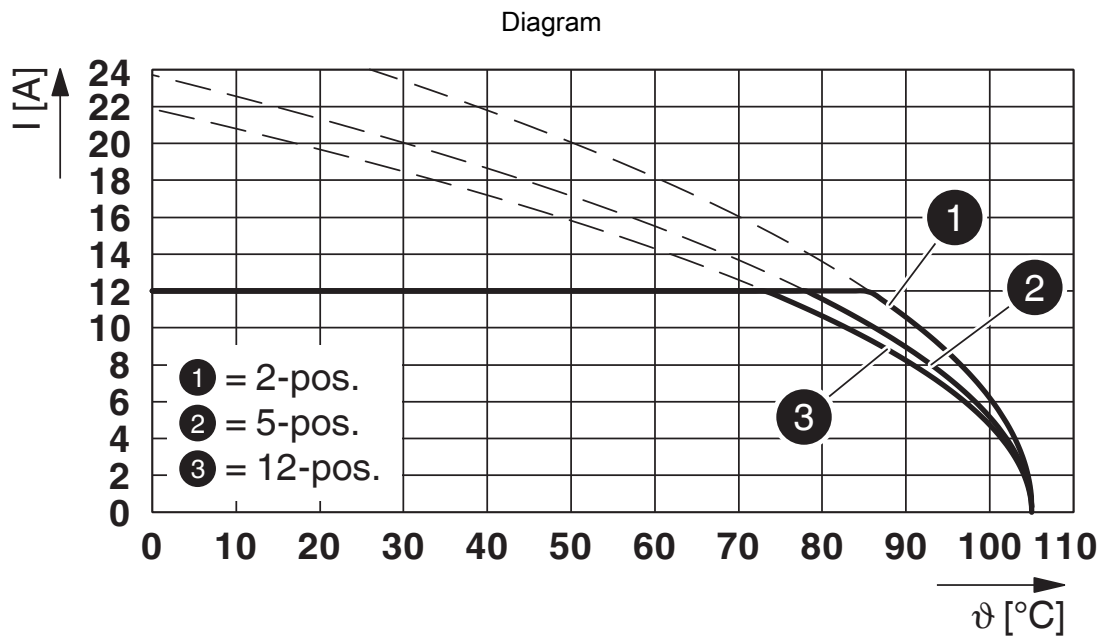

Type: FKCVR 2,5/...-ST-5,08 with CCV 2,5/...-G-5,08 P26THR

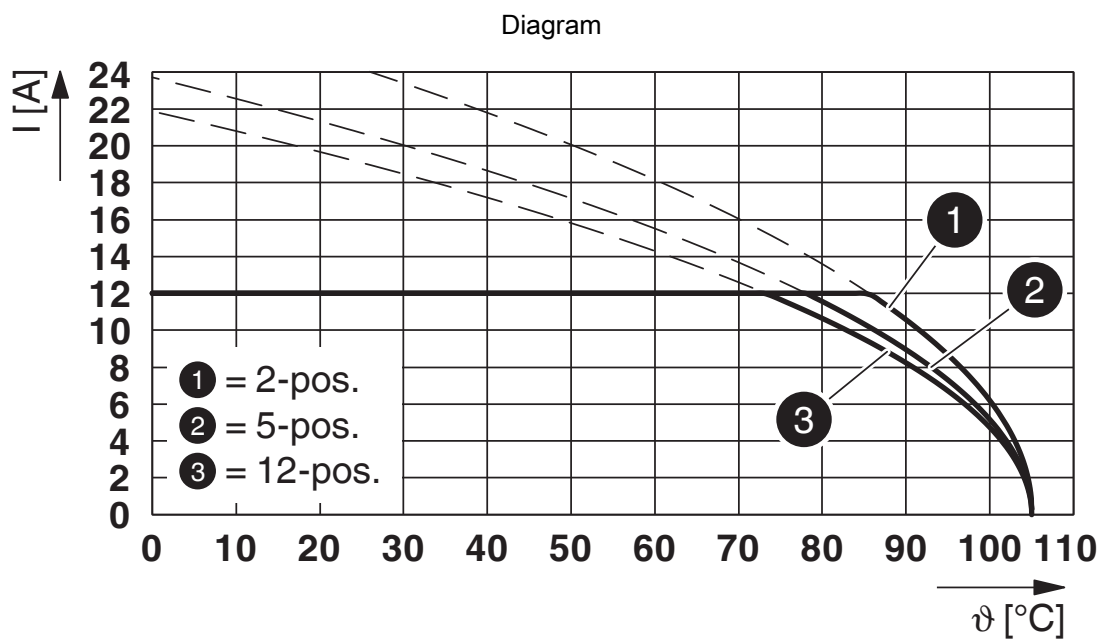

Type: FKCVW 2,5/...-ST-5,08 with CCV 2,5/...-G-5,08 P26THR

1955552

<https://www.phoenixcontact.com/us/products/1955552>

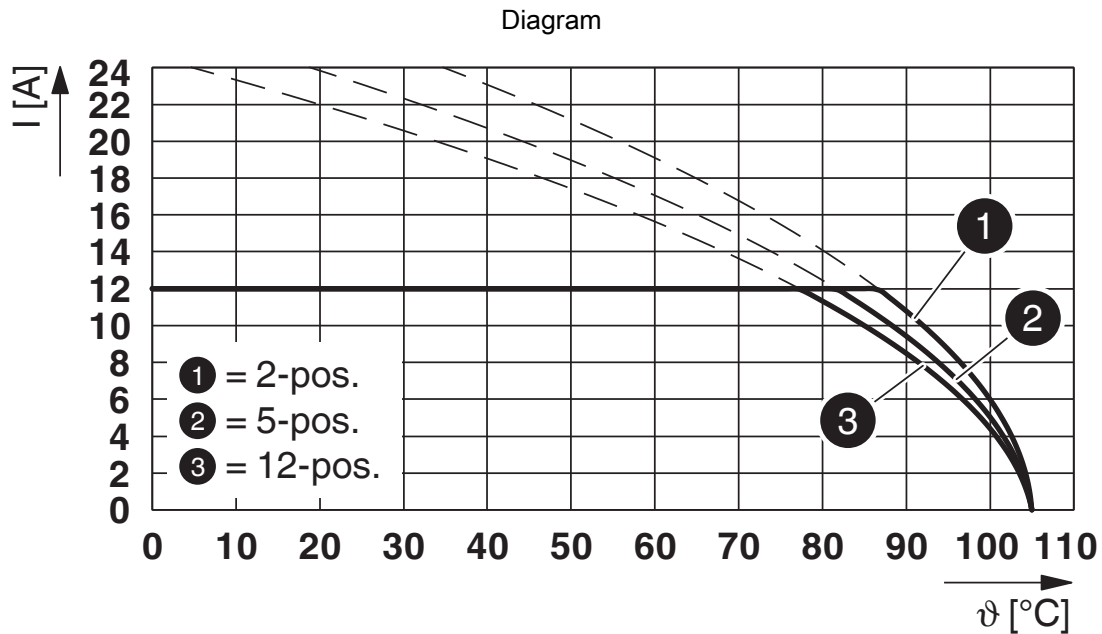

Type: FKCN 2,5/...-ST-5,08 with CCV 2,5/...-G-5,08 P...THR

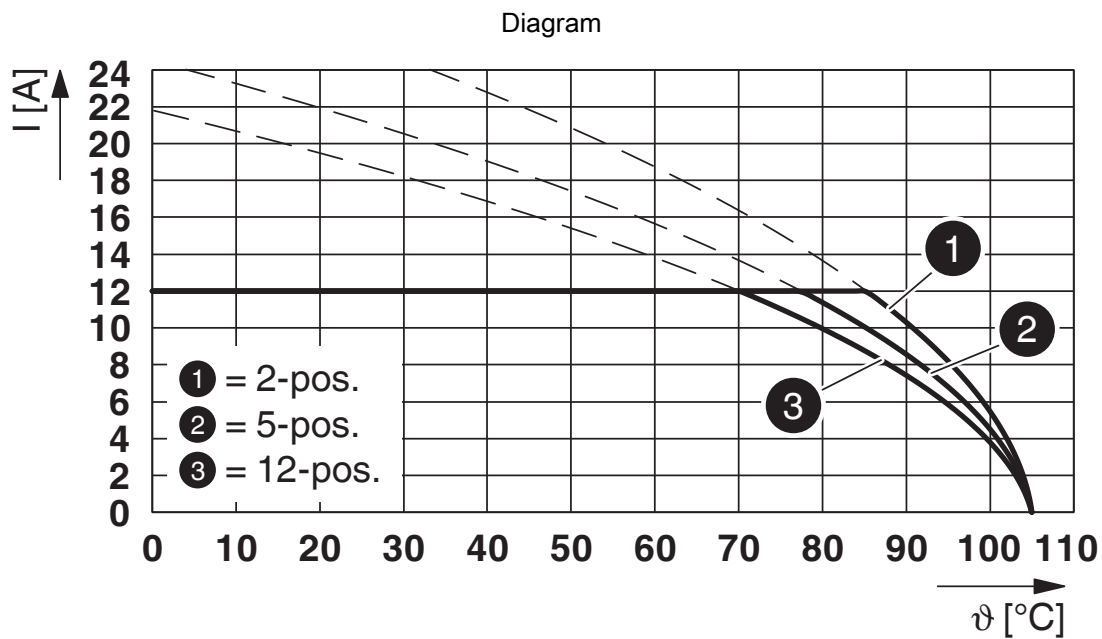

Type: FKCT 2,5/...-ST-5,08 with CCV 2,5/...-G-5,08 P...THR

1955552

<https://www.phoenixcontact.com/us/products/1955552>

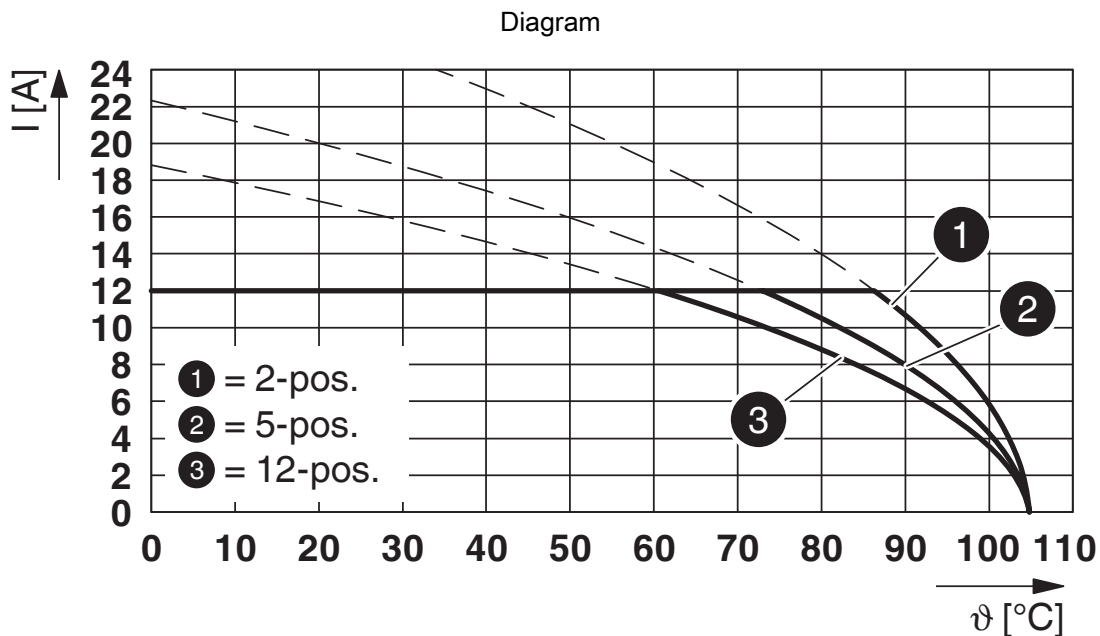

Type: ICV 2,5/...-G-5,08 with CCV 2,5/...-G-5,08 P...THR

Drilling plan/solder pad geometry

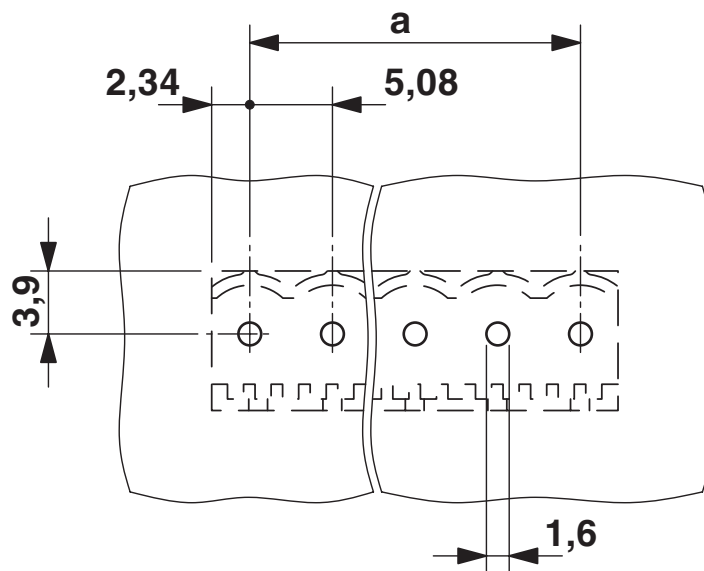

1955552

<https://www.phoenixcontact.com/us/products/1955552>

Approvals

To download certificates, visit the product detail page: <https://www.phoenixcontact.com/us/products/1955552>

 cULus Recognized Approval ID: E60425-19931011				
	Nominal voltage U_N	Nominal current I_N	Cross section AWG	Cross section mm^2
B				
Standard	300 V	16 A	-	-
D				
Standard	300 V	10 A	-	-
Alternative 1	150 V	15 A	-	-

 VDE report with production monitoring Approval ID: 40041286				
	Nominal voltage U_N	Nominal current I_N	Cross section AWG	Cross section mm^2
keine				
	400 V	12 A	-	-

 VDE approval of drawings Approval ID: 40050079				
	Nominal voltage U_N	Nominal current I_N	Cross section AWG	Cross section mm^2
keine				
	320 V	16 A	-	-

1955552

<https://www.phoenixcontact.com/us/products/1955552>

Classifications

ECLASS

ECLASS-13.0	27460201
ECLASS-15.0	27460201

ETIM

ETIM 10.0	EC002637
-----------	----------

UNSPSC

UNSPSC 21.0	39121400
-------------	----------

1955552

<https://www.phoenixcontact.com/us/products/1955552>

Environmental product compliance

EU RoHS

Fulfills EU RoHS substance requirements	Yes, No exemptions
---	--------------------

China RoHS

Environment friendly use period (EFUP)	EFUP-E
	No hazardous substances above the limits

EU REACH SVHC

REACH candidate substance (CAS No.)	No substance above 0.1 wt%
-------------------------------------	----------------------------

Phoenix Contact 2026 © - all rights reserved
<https://www.phoenixcontact.com>

Phoenix Contact USA
586 Fulling Mill Road
Middletown, PA 17057, United States
(+717) 944-1300
info@phoenixcon.com