

# FMC 1,5/13-ST-3,5 - PCB connector

1952377

<https://www.phoenixcontact.com/us/products/1952377>

Please be informed that the data shown in this PDF document is generated from our online catalog. Please find the complete data in the user documentation. Our general terms of use for downloads are valid.



PCB connector, nominal cross section: 1.5 mm<sup>2</sup>, color: green, nominal current: 8 A, rated voltage (III/2): 160 V, contact surface: Sn, contact connection type: Socket, number of potentials: 13, number of rows: 1, number of positions: 13, number of connections: 13, product range: FMC 1,5/..-ST, pitch: 3.5 mm, connection method: Push-in spring connection, conductor/PCB connection direction: 0 °, plug-in system: COMBICON FMC 1,5 - MCDN 1,5, locking: without, mounting method: without, type of packaging: packed in cardboard

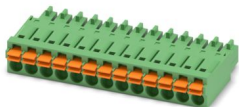

## Your advantages

- Time saving push-in connection, tools not required
- Defined contact force ensures that contact remains stable over the long term
- Intuitive operation due to color-coded actuating push button
- Operation and conductor connection from one direction enable integration into front of device

## Commercial data

Item number	1952377
Packing unit	50 pc
Minimum order quantity	50 pc
Sales key	AA02
Product key	AABFAA
GTIN	4017918942960
Weight per piece (including packing)	7.526 g
Weight per piece (excluding packing)	6.924 g
Customs tariff number	85366990
Country of origin	DE

# FMC 1,5/13-ST-3,5 - PCB connector



1952377

<https://www.phoenixcontact.com/us/products/1952377>

## Technical data

### Product properties

Product type	PCB connector
Product family	FMC 1,5/..-ST
Product line	COMBICON Connectors S
Type	Standard
Number of positions	13
Pitch	3.5 mm
Number of connections	13
Number of rows	1
Number of potentials	13
Mounting type	without

### Electrical properties

#### Properties

Nominal current $I_N$	8 A
Nominal voltage $U_N$	160 V
Contact resistance	1.5 mΩ
Rated voltage (III/3)	160 V
Rated surge voltage (III/3)	2.5 kV
Rated voltage (III/2)	160 V
Rated surge voltage (III/2)	2.5 kV
Rated voltage (II/2)	320 V
Rated surge voltage (II/2)	2.5 kV

### Connection data

#### Connection technology

Type	Standard
Connector system	COMBICON FMC 1,5 - MCDN 1,5
	COMBICON FMC 1,5 - MCDN 1,5
Nominal cross section	1.5 mm <sup>2</sup>
Contact connection type	Socket

#### Interlock

Locking type	without
Mounting type	without

#### Conductor connection

Connection method	Push-in spring connection
Conductor/PCB connection direction	0 °
Conductor cross-section rigid	0.2 mm <sup>2</sup> ... 1.5 mm <sup>2</sup>
Conductor cross-section flexible	0.2 mm <sup>2</sup> ... 1.5 mm <sup>2</sup>

# FMC 1,5/13-ST-3,5 - PCB connector



1952377

<https://www.phoenixcontact.com/us/products/1952377>

Conductor cross-section AWG	24 ... 16
Conductor cross-section, flexible, with ferrule, without plastic sleeve	0.25 mm <sup>2</sup> ... 1.5 mm <sup>2</sup>
Conductor cross-section, flexible, with ferrule, with plastic sleeve	0.14 mm <sup>2</sup> ... 0.75 mm <sup>2</sup>
Cylindrical gauge a x b / diameter	2.4 mm x 1.5 mm / 1.6 mm
Stripping length	10 mm

## Specifications for ferrules without insulating collar

recommended crimping tool	1212034 CRIMPFOX 6
ferrules without insulating collar, according to DIN 46228-1	Cross section: 0.25 mm <sup>2</sup> ; Length: 7 mm
	Cross section: 0.34 mm <sup>2</sup> ; Length: 7 mm
	Cross section: 0.5 mm <sup>2</sup> ; Length: 8 mm ... 10 mm
	Cross section: 0.75 mm <sup>2</sup> ; Length: 8 mm ... 10 mm
	Cross section: 1 mm <sup>2</sup> ; Length: 8 mm ... 10 mm
	Cross section: 1.5 mm <sup>2</sup> ; Length: 10 mm

## Specifications for ferrules with insulating collar

recommended crimping tool	1212034 CRIMPFOX 6
ferrules with insulating collar, according to DIN 46228-4	Cross section: 0.14 mm <sup>2</sup> ; Length: 8 mm
	Cross section: 0.25 mm <sup>2</sup> ; Length: 8 mm ... 10 mm
	Cross section: 0.34 mm <sup>2</sup> ; Length: 8 mm ... 10 mm
	Cross section: 0.5 mm <sup>2</sup> ; Length: 8 mm ... 10 mm
	Cross section: 0.75 mm <sup>2</sup> ; Length: 10 mm

## Material specifications

### Material data - contact

Note	WEEE/RoHS-compliant, free of whiskers according to IEC 60068-2-82/JEDEC JESD 201
Contact material	Cu alloy
Surface characteristics	hot-dip tin-plated
Metal surface terminal point (top layer)	Tin (4 µm - 8 µm Sn)
Metal surface contact area (top layer)	Tin (4 µm - 8 µm Sn)

### Material data - housing

Color (Housing)	green (6021)
Insulating material	PA
Insulating material group	I
CTI according to IEC 60112	600
Flammability rating according to UL 94	V0
Glow wire flammability index GWFI according to EN 60695-2-12	850
Glow wire ignition temperature GWIT according to EN 60695-2-13	775
Temperature for the ball pressure test according to EN 60695-10-2	125 °C

### Material data – actuating element

# FMC 1,5/13-ST-3,5 - PCB connector



1952377

<https://www.phoenixcontact.com/us/products/1952377>

Color (Actuating element)	orange (2003)
Insulating material	PBT
Insulating material group	IIIa
CTI according to IEC 60112	275
Flammability rating according to UL 94	V0

## Dimensions

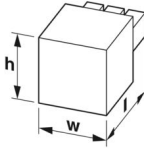
Dimensional drawing	
Pitch	3.5 mm
Width [w]	46.25 mm
Height [h]	7.75 mm
Length [l]	21.9 mm

## Mechanical tests

### Conductor connection

Specification	IEC 60999-1:1999-11
Result	Test passed

### Test for conductor damage and slackening

Specification	IEC 60999-1:1999-11
Result	Test passed

### Repeated connection and disconnection

Specification	IEC 60999-1:1999-11
Result	Test passed

### Pull-out test

Specification	IEC 60999-1:1999-11
Conductor cross-section/conductor type/tractive force setpoint/actual value	0.2 mm <sup>2</sup> / solid / > 10 N
	0.2 mm <sup>2</sup> / flexible / > 10 N
	1.5 mm <sup>2</sup> / solid / > 40 N
	1.5 mm <sup>2</sup> / flexible / > 40 N

### Insertion and withdrawal forces

Specification	IEC 60512-13-2:2006-02
Result	Test passed
No. of cycles	25
Insertion strength per pos. approx.	8 N
Withdraw strength per pos. approx.	6 N

### Resistance of inscriptions

# FMC 1,5/13-ST-3,5 - PCB connector



1952377

<https://www.phoenixcontact.com/us/products/1952377>

Specification	IEC 60068-2-70:1995-12
Result	Test passed

## Polarization and coding

Specification	IEC 60512-13-5:2006-02
Result	Test passed

## Visual inspection

Specification	IEC 60512-1-1:2002-02
Result	Test passed

## Dimension check

Specification	IEC 60512-1-2:2002-02
Result	Test passed

## Environmental and real-life conditions

### Durability test

Specification	IEC 60512-9-1:2010-03
Impulse withstand voltage at sea level	2.95 kV
Contact resistance $R_1$	1.5 m $\Omega$
Contact resistance $R_2$	1.6 m $\Omega$
Insertion/withdrawal cycles	25
Insulation resistance, neighboring positions	> 5 M $\Omega$

### Climatic test

Specification	ISO 6988:1985-02
Corrosive stress	0.2 dm <sup>3</sup> SO <sub>2</sub> on 300 dm <sup>3</sup> /40 °C/1 cycle
Thermal stress	100 °C/168 h
Power-frequency withstand voltage	1.39 kV

### Vibration test

Specification	IEC 60068-2-6:2007-12
Frequency	10 - 150 - 10 Hz
Sweep speed	1 octave/min
Amplitude	0.35 mm (10 Hz ... 60.1 Hz)
Acceleration	5g (60.1 Hz ... 150 Hz)
Test duration per axis	2.5 h
Test directions	X-, Y- and Z-axis

### Ambient conditions

Ambient temperature (storage/transport)	-40 °C ... 70 °C
Relative humidity (storage/transport)	30 % ... 70 %
Ambient temperature (assembly)	-5 °C ... 100 °C
Ambient temperature (operation)	-40 °C ... 100 °C (dependent on the derating curve)

## Electrical tests

# FMC 1,5/13-ST-3,5 - PCB connector



1952377

<https://www.phoenixcontact.com/us/products/1952377>

## Thermal test | Test group C

Specification	IEC 60512-5-1:2002-02
Tested number of positions	20

## Insulation resistance

Specification	IEC 60512-3-1:2002-02
Insulation resistance, neighboring positions	> 5 MΩ

## Air clearances and creepage distances |

Specification	IEC 60664-1:2007-04
Insulating material group	I
Comparative tracking index (IEC 60112)	CTI 600
Rated insulation voltage (III/3)	160 V
Rated surge voltage (III/3)	2.5 kV
minimum clearance value - non-homogenous field (III/3)	1.5 mm
minimum creepage distance (III/3)	2 mm
Rated insulation voltage (III/2)	160 V
Rated surge voltage (III/2)	2.5 kV
minimum clearance value - non-homogenous field (III/2)	1.5 mm
minimum creepage distance (III/2)	1.5 mm
Rated insulation voltage (II/2)	320 V
Rated surge voltage (II/2)	2.5 kV
minimum clearance value - non-homogenous field (II/2)	1.5 mm
minimum creepage distance (II/2)	1.6 mm

## Packaging specifications

Type of packaging	packed in cardboard
-------------------	---------------------

# FMC 1,5/13-ST-3,5 - PCB connector

1952377

<https://www.phoenixcontact.com/us/products/1952377>

## Drawings

Dimensional drawing



Diagram



Type: FMC 1,5/...-ST-3,5 with MCV 1,5/...-G-3,5

1952377

<https://www.phoenixcontact.com/us/products/1952377>

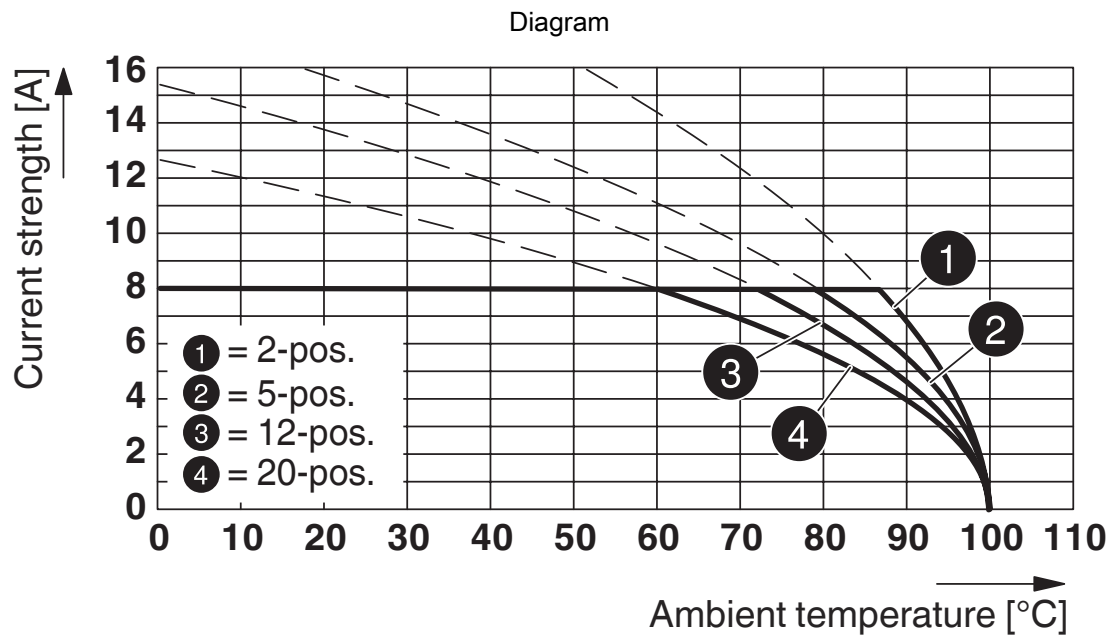

Type: FMC 1,5/...-ST-3,5 with MCV 1,5/...-G-3,5 P... THR

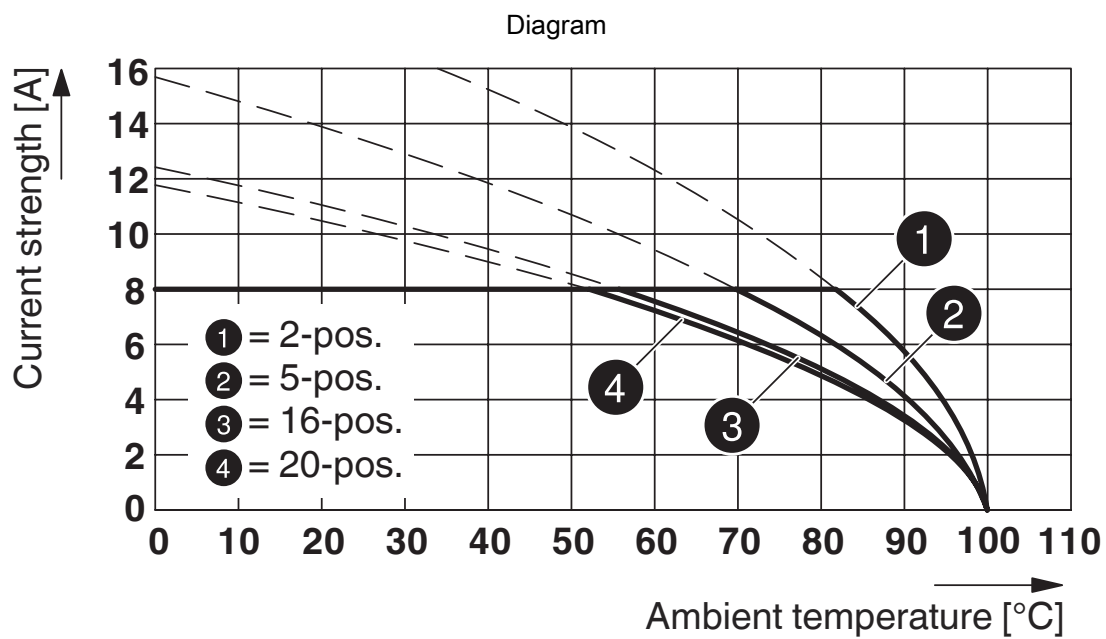

Type: FMC 1,5/...-ST-3,5 with MCDNV 1,5/...-G1-3,5 P... THR

1952377

<https://www.phoenixcontact.com/us/products/1952377>

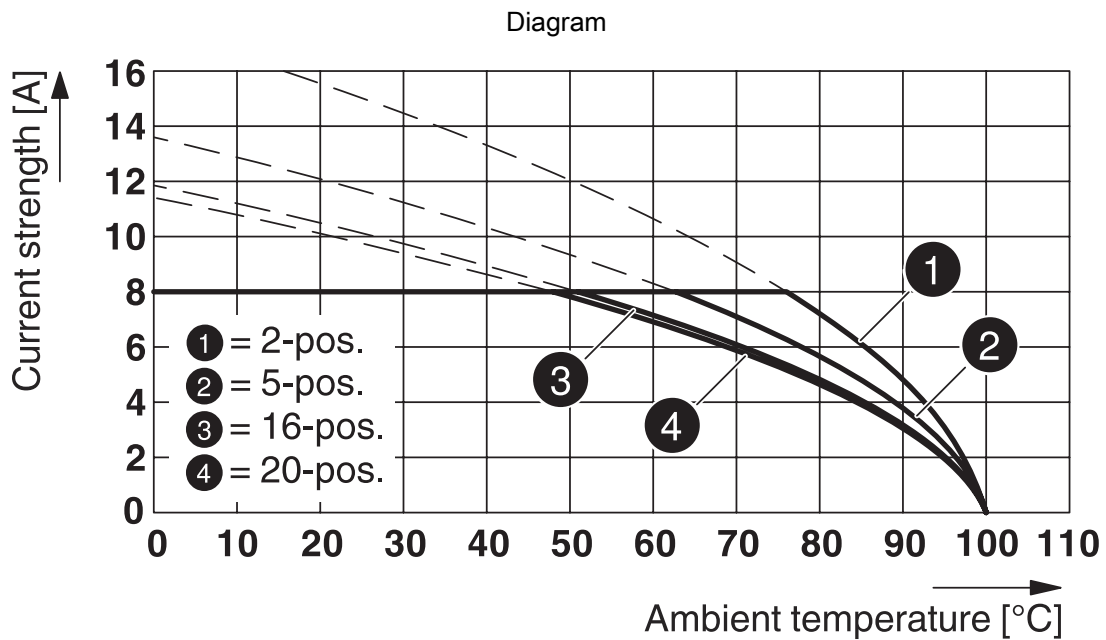

Type: FMC 1,5/...-ST-3,5 with MCDN 1,5/...-G1-3,5 P26THR

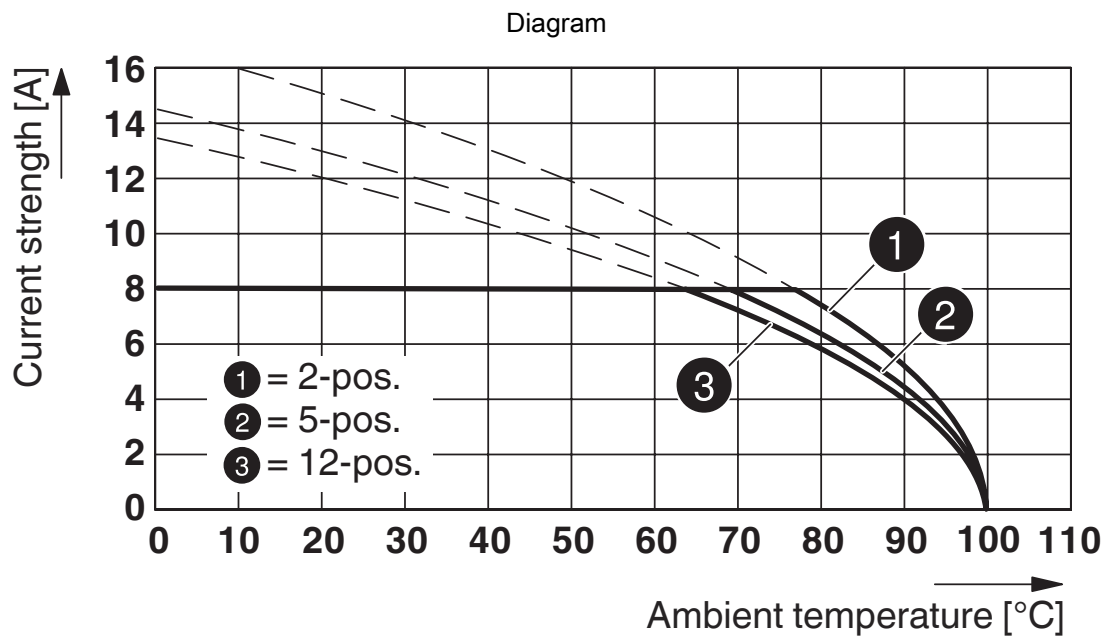

Type: FMC 1,5/...-ST-3,5 with IFMC 1,5/...-ST-3,5

# FMC 1,5/13-ST-3,5 - PCB connector



1952377

<https://www.phoenixcontact.com/us/products/1952377>

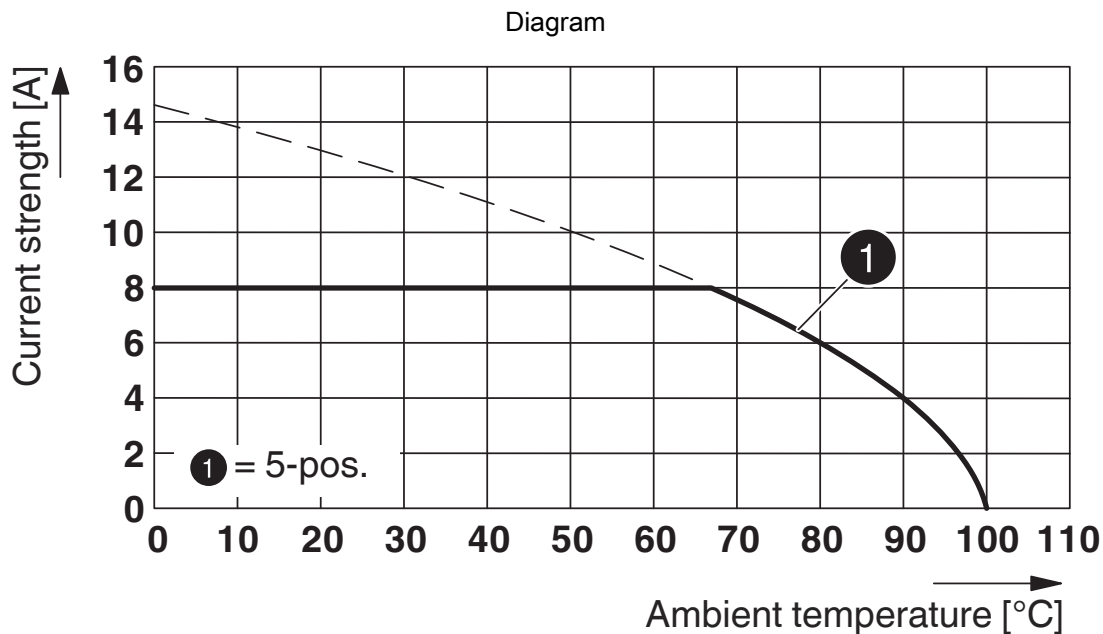

Type: FMC 1,5/...-ST-3,5 with MCD 1,5/...-G3-3,5 P26 THR MAG

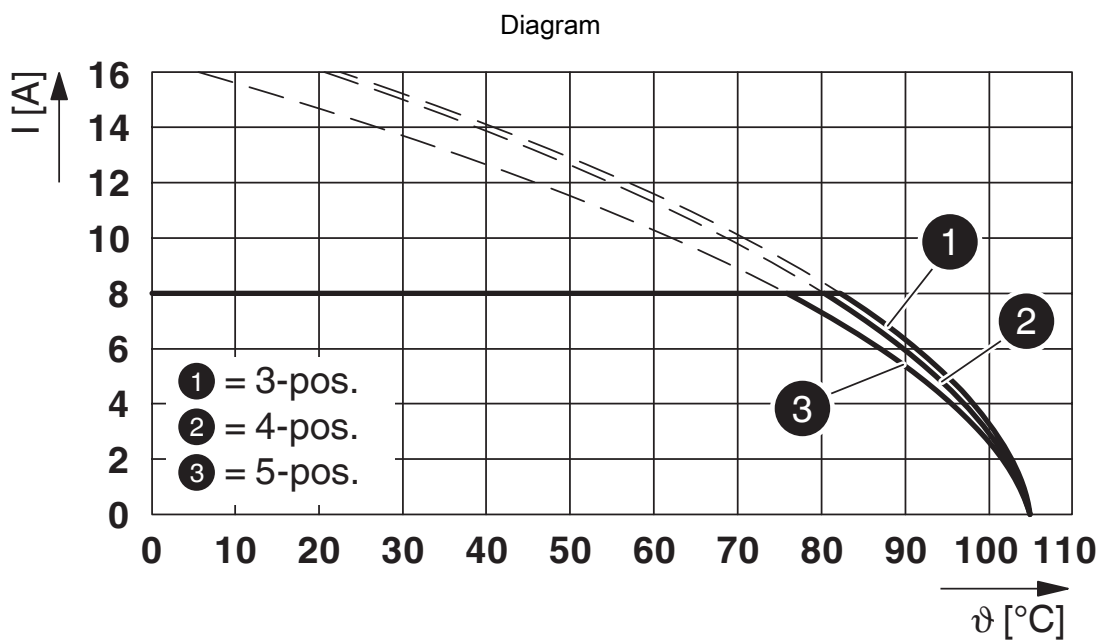

Type: FMC 1,5/...-ST-3,5 with MCO 1,5/...-G1L-3,5 KMGY

# FMC 1,5/13-ST-3,5 - PCB connector



1952377

<https://www.phoenixcontact.com/us/products/1952377>

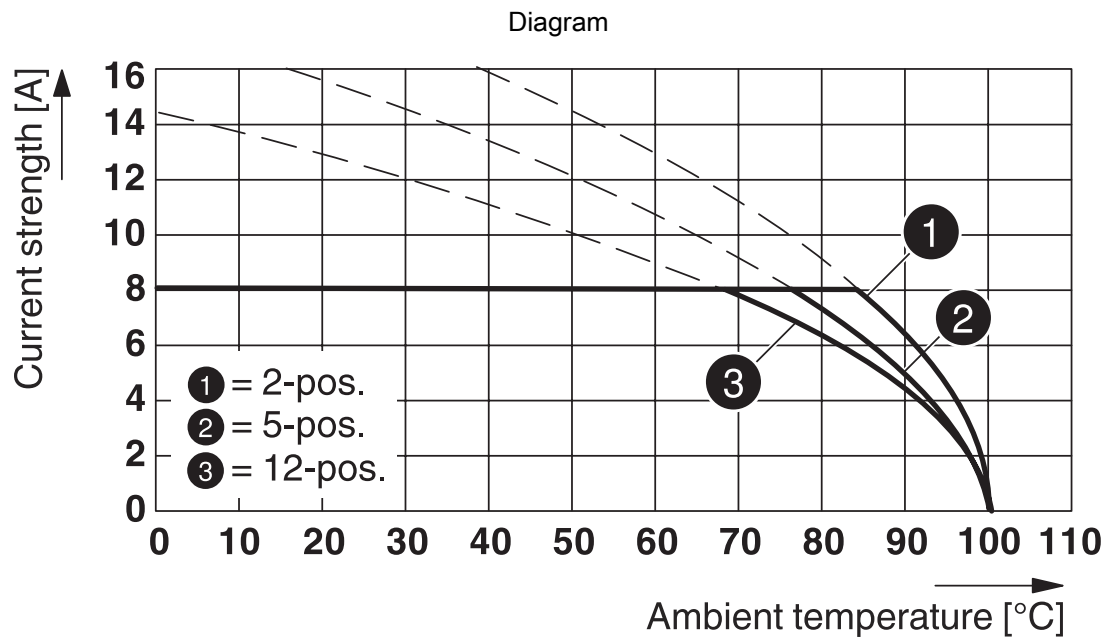

Type: FMC 1,5/...-ST-3,5 with MC 1,5/...-G-3,5 P... THR

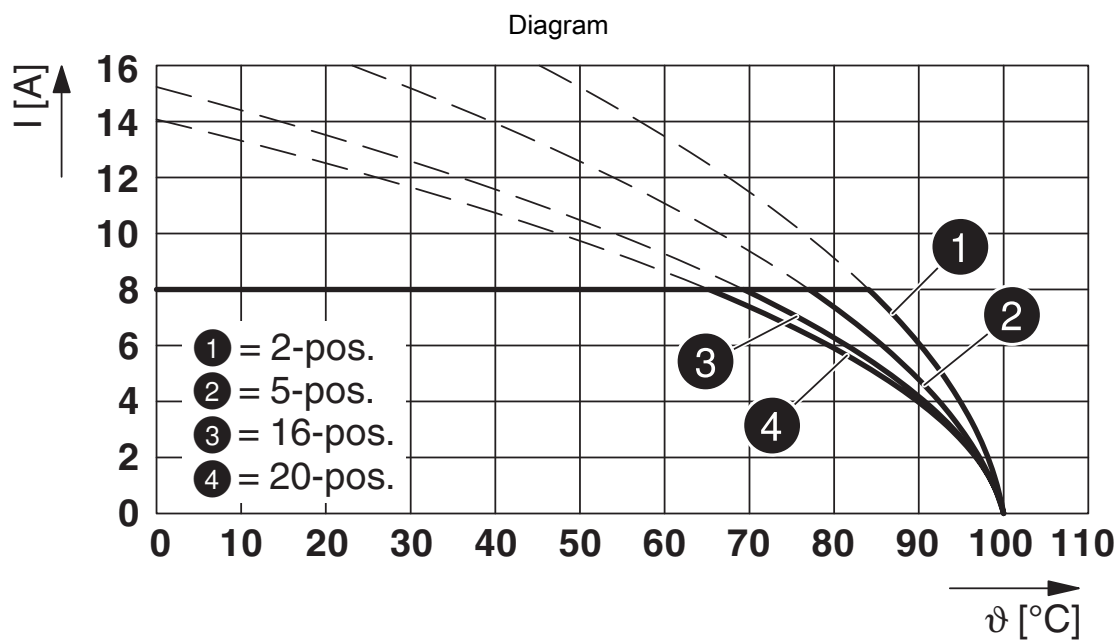

Type: FMC 1,5/...-ST-3,5 with MCV 1,5/...-G-3,5 THT

# FMC 1,5/13-ST-3,5 - PCB connector



1952377

<https://www.phoenixcontact.com/us/products/1952377>

## Approvals

To download certificates, visit the product detail page: <https://www.phoenixcontact.com/us/products/1952377>

 <b>cULus Recognized</b> Approval ID: E60425-19920306		Nominal voltage $U_N$	Nominal current $I_N$	Cross section AWG	Cross section $\text{mm}^2$
<b>B</b>					
Field wiring	150 V	8 A	24 - 16	-	
<b>C</b>					
Factory wiring	50 V	8 A	24 - 16	-	

 **VDE approval of drawings**  
Approval ID: 40011723

 **VDE approval of drawings**  
Approval ID: 40011723

# FMC 1,5/13-ST-3,5 - PCB connector



1952377

<https://www.phoenixcontact.com/us/products/1952377>

## Classifications

### ECLASS

ECLASS-13.0	27460202
ECLASS-15.0	27460202

### ETIM

ETIM 10.0	EC002638
-----------	----------

### UNSPSC

UNSPSC 21.0	39121400
-------------	----------

# FMC 1,5/13-ST-3,5 - PCB connector



1952377

<https://www.phoenixcontact.com/us/products/1952377>

## Environmental product compliance

### EU RoHS

Fulfills EU RoHS substance requirements	Yes, No exemptions
---	--------------------

### China RoHS

Environment friendly use period (EFUP)	EFUP-E
	No hazardous substances above the limits

### EU REACH SVHC

REACH candidate substance (CAS No.)	No substance above 0.1 wt%
-------------------------------------	----------------------------

### EF3.1 Climate Change

CO2e kg	0.173 kg CO2e
---------	---------------

Phoenix Contact 2026 © - all rights reserved  
<https://www.phoenixcontact.com>

Phoenix Contact USA  
586 Fulling Mill Road  
Middletown, PA 17057, United States  
(+717) 944-1300  
[info@phoenixcon.com](mailto:info@phoenixcon.com)