

# FK-MCP 1,5/ 3-STF-3,5 - PCB connector



1940101

<https://www.phoenixcontact.com/us/products/1940101>

Please be informed that the data shown in this PDF document is generated from our online catalog. Please find the complete data in the user documentation. Our general terms of use for downloads are valid.

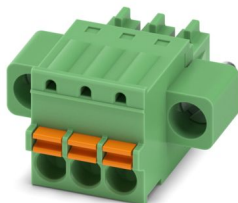

PCB connector, nominal cross section: 1.5 mm<sup>2</sup>, color: green, nominal current: 8 A, rated voltage (III/2): 160 V, contact surface: Sn, contact connection type: Socket, number of potentials: 3, number of rows: 1, number of positions: 3, number of connections: 3, product range: FK-MCP 1,5/..-STF, pitch: 3.5 mm, connection method: Push-in spring connection, conductor/PCB connection direction: 0 °, plug-in system: COMBICON MC 1,5, locking: Screw locking mechanism, mounting method: Screw flange, type of packaging: packed in cardboard

## Your advantages

- Time saving push-in connection, tools not required
- Defined contact force ensures that contact remains stable over the long term
- Intuitive operation due to color-coded actuating push button
- Screwable flange for superior mechanical stability
- Quick and convenient testing using integrated test option

## Commercial data

Item number	1940101
Packing unit	50 pc
Minimum order quantity	50 pc
Sales key	AA02
Product key	AABFMB
GTIN	4017918889425
Weight per piece (including packing)	3.738 g
Weight per piece (excluding packing)	3.419 g
Customs tariff number	85366990
Country of origin	DE

# FK-MCP 1,5/ 3-STF-3,5 - PCB connector



1940101

<https://www.phoenixcontact.com/us/products/1940101>

## Technical data

### Product properties

Product type	PCB connector
Product family	FK-MCP 1,5/...-STF
Product line	COMBICON Connectors S
Type	Standard
Number of positions	3
Pitch	3.5 mm
Number of connections	3
Number of rows	1
Number of potentials	3
Mounting type	Screw flange

### Electrical properties

#### Properties

Nominal current $I_N$	8 A
Nominal voltage $U_N$	160 V
Contact resistance	2 mΩ
Rated voltage (III/3)	160 V
Rated surge voltage (III/3)	2.5 kV
Rated voltage (III/2)	160 V
Rated surge voltage (III/2)	2.5 kV
Rated voltage (II/2)	320 V
Rated surge voltage (II/2)	2.5 kV

### Connection data

#### Connection technology

Type	Standard
Connector system	COMBICON MC 1,5
Nominal cross section	1.5 mm <sup>2</sup>
Contact connection type	Socket

#### Interlock

Locking type	Screw locking mechanism
Mounting type	Screw flange
Tightening torque	0.3 Nm

#### Conductor connection

Connection method	Push-in spring connection
Conductor/PCB connection direction	0 °
Conductor cross-section rigid	0.14 mm <sup>2</sup> ... 1.5 mm <sup>2</sup>
Conductor cross-section flexible	0.14 mm <sup>2</sup> ... 1.5 mm <sup>2</sup>

# FK-MCP 1,5/ 3-STF-3,5 - PCB connector



1940101

<https://www.phoenixcontact.com/us/products/1940101>

Conductor cross-section AWG	26 ... 16
Conductor cross-section, flexible, with ferrule, without plastic sleeve	0.25 mm <sup>2</sup> ... 1.5 mm <sup>2</sup>
Conductor cross-section, flexible, with ferrule, with plastic sleeve	0.25 mm <sup>2</sup> ... 0.5 mm <sup>2</sup>
Cylindrical gauge a x b / diameter	2.4 mm x 1.5 mm / -
Stripping length	9 mm

## Specifications for ferrules without insulating collar

recommended crimping tool	1212034 CRIMPFOX 6
ferrules without insulating collar, according to DIN 46228-1	Cross section: 0.25 mm <sup>2</sup> ; Length: 7 mm
	Cross section: 0.34 mm <sup>2</sup> ; Length: 7 mm
	Cross section: 0.5 mm <sup>2</sup> ; Length: 8 mm ... 10 mm
	Cross section: 0.75 mm <sup>2</sup> ; Length: 8 mm ... 10 mm
	Cross section: 1 mm <sup>2</sup> ; Length: 8 mm ... 10 mm
	Cross section: 1.5 mm <sup>2</sup> ; Length: 10 mm

## Specifications for ferrules with insulating collar

recommended crimping tool	1212034 CRIMPFOX 6
ferrules with insulating collar, according to DIN 46228-4	Cross section: 0.14 mm <sup>2</sup> ; Length: 8 mm
	Cross section: 0.25 mm <sup>2</sup> ; Length: 8 mm
	Cross section: 0.34 mm <sup>2</sup> ; Length: 8 mm
	Cross section: 0.5 mm <sup>2</sup> ; Length: 8 mm ... 10 mm

## Material specifications

### Material data - contact

Note	WEEE/RoHS-compliant, free of whiskers according to IEC 60068-2-82/JEDEC JESD 201
Contact material	Cu alloy
Surface characteristics	hot-dip tin-plated
Metal surface terminal point (top layer)	Tin (4 μm - 8 μm Sn)
Metal surface contact area (top layer)	Tin (4 μm - 8 μm Sn)

### Material data - housing

Color (Housing)	green (6021)
Insulating material	PA
Insulating material group	I
CTI according to IEC 60112	600
Flammability rating according to UL 94	V0
Glow wire flammability index GWFI according to EN 60695-2-12	850
Glow wire ignition temperature GWIT according to EN 60695-2-13	775
Temperature for the ball pressure test according to EN 60695-10-2	125 °C

### Material data – actuating element

Color (Actuating element)	orange (2003)
---------------------------	---------------

# FK-MCP 1,5/ 3-STF-3,5 - PCB connector



1940101

<https://www.phoenixcontact.com/us/products/1940101>

Insulating material	POM
Insulating material group	I
CTI according to IEC 60112	600
Flammability rating according to UL 94	HB

## Dimensions

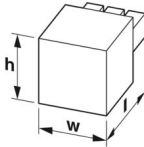
Dimensional drawing	
Pitch	3.5 mm
Width [w]	20.8 mm
Height [h]	12.4 mm
Length [l]	20.8 mm

## Mounting

### Flange

Tightening torque	0.3 Nm
-------------------	--------

## Mechanical tests

### Conductor connection

Specification	IEC 60999-1:1999-11
Result	Test passed

### Test for conductor damage and slackening

Specification	IEC 60999-1:1999-11
Result	Test passed

### Repeated connection and disconnection

Specification	IEC 60999-1:1999-11
Result	Test passed

### Pull-out test

Specification	IEC 60999-1:1999-11
Conductor cross-section/conductor type/tractive force setpoint/actual value	0.14 mm <sup>2</sup> / solid / > 10 N
	0.14 mm <sup>2</sup> / flexible / > 10 N
	1.5 mm <sup>2</sup> / solid / > 40 N
	1.5 mm <sup>2</sup> / flexible / > 40 N

### Insertion and withdrawal forces

Specification	IEC 60512-13-2:2006-02
Result	Test passed
No. of cycles	25

# FK-MCP 1,5/ 3-STF-3,5 - PCB connector



1940101

<https://www.phoenixcontact.com/us/products/1940101>

Insertion strength per pos. approx.	7 N
Withdraw strength per pos. approx.	5 N

## Resistance of inscriptions

Specification	IEC 60068-2-70:1995-12
Result	Test passed

## Polarization and coding

Specification	IEC 60512-13-5:2006-02
Result	Test passed

## Visual inspection

Specification	IEC 60512-1-1:2002-02
Result	Test passed

## Dimension check

Specification	IEC 60512-1-2:2002-02
Result	Test passed

## Environmental and real-life conditions

### Durability test

Specification	IEC 60512-5:1992-08
Impulse withstand voltage at sea level	2.95 kV
Contact resistance $R_1$	2 m $\Omega$
Contact resistance $R_2$	2.2 m $\Omega$
Insertion/withdrawal cycles	25

### Climatic test

Specification	ISO 6988:1985-02
Corrosive stress	0.2 dm <sup>3</sup> SO <sub>2</sub> on 300 dm <sup>3</sup> /40 °C/1 cycle
Thermal stress	100 °C/168 h
Power-frequency withstand voltage	1.39 kV

### Vibration test

Specification	IEC 60068-2-6:2007-12
Frequency	10 - 150 - 10 Hz
Sweep speed	1 octave/min
Amplitude	0.35 mm (10 Hz ... 60.1 Hz)
Acceleration	5g (60.1 Hz ... 150 Hz)
Test duration per axis	2.5 h
Test directions	X-, Y- and Z-axis

### Shocks

Specification	IEC 60068-2-27:2008-02
Pulse shape	Semi-sinusoidal
Acceleration	30g
Shock duration	18 ms

# FK-MCP 1,5/ 3-STF-3,5 - PCB connector



1940101

<https://www.phoenixcontact.com/us/products/1940101>

Test directions	X-, Y- and Z-axis (pos. and neg.)
-----------------	-----------------------------------

## Railway application: Shocks

Acceleration	30g
Shock duration	18 ms
Test directions	X-, Y- and Z-axis (pos. and neg.)

## Ambient conditions

Ambient temperature (storage/transport)	-40 °C ... 70 °C
Relative humidity (storage/transport)	30 % ... 70 %
Ambient temperature (assembly)	-5 °C ... 100 °C
Ambient temperature (operation)	-40 °C ... 100 °C (dependent on the derating curve)

## Electrical tests

### Thermal test | Test group C

Specification	IEC 60512-5-1:2002-02
Tested number of positions	20

### Insulation resistance

Specification	IEC 60512-3-1:2002-02
Insulation resistance, neighboring positions	$10^{12} \Omega$

### Temperature cycles

Specification	IEC 60999-1:1999-11
Result	Test passed

### Air clearances and creepage distances |

Specification	IEC 60664-1:2007-04
Insulating material group	I
Comparative tracking index (IEC 60112)	CTI 600
Rated insulation voltage (III/3)	160 V
Rated surge voltage (III/3)	2.5 kV
minimum clearance value - non-homogenous field (III/3)	1.5 mm
minimum creepage distance (III/3)	2 mm
Rated insulation voltage (III/2)	160 V
Rated surge voltage (III/2)	2.5 kV
minimum clearance value - non-homogenous field (III/2)	1.5 mm
minimum creepage distance (III/2)	1.5 mm
Rated insulation voltage (II/2)	320 V
Rated surge voltage (II/2)	2.5 kV
minimum clearance value - non-homogenous field (II/2)	1.5 mm
minimum creepage distance (II/2)	1.6 mm

## Packaging specifications

Type of packaging	packed in cardboard
-------------------	---------------------

# FK-MCP 1,5/ 3-STF-3,5 - PCB connector

1940101

<https://www.phoenixcontact.com/us/products/1940101>

## Drawings

Dimensional drawing

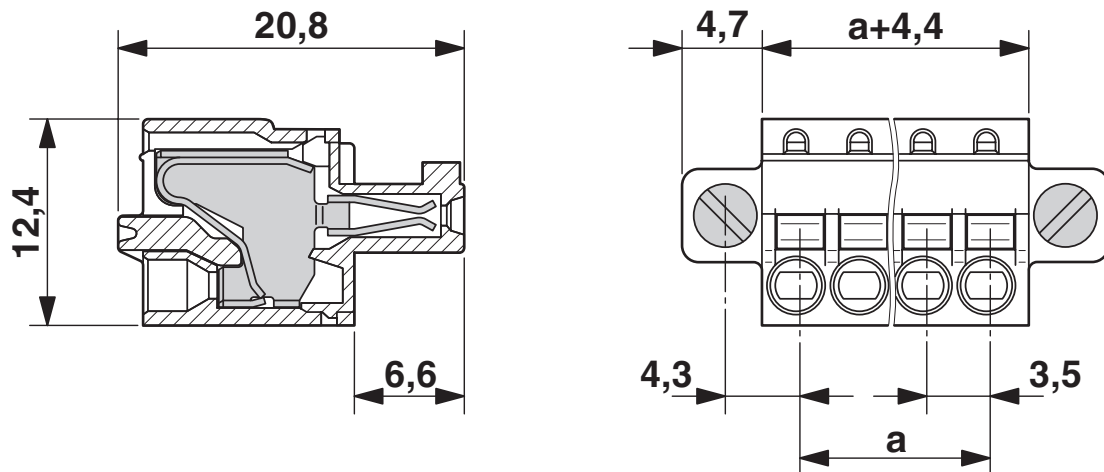

Diagram

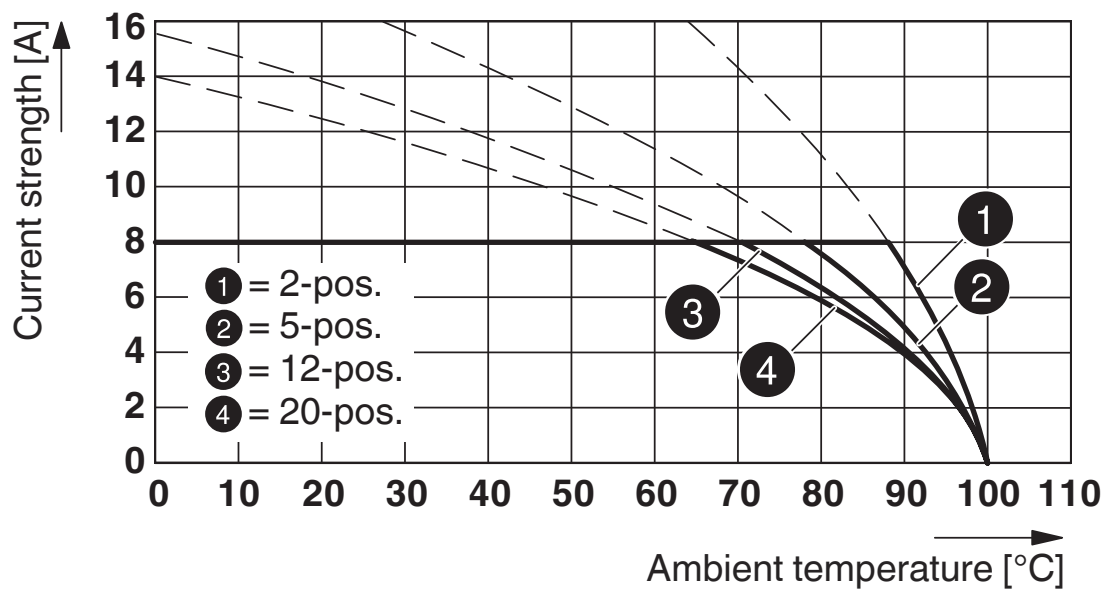

Type: FK-MCP 1,5/...-STF-3,5 with MC 1,5/...-GF-3,5

1940101

<https://www.phoenixcontact.com/us/products/1940101>



Type: FK-MCP 1,5/...-STF-3,5 with MCV 1,5/...-GF-3,5 P...THR

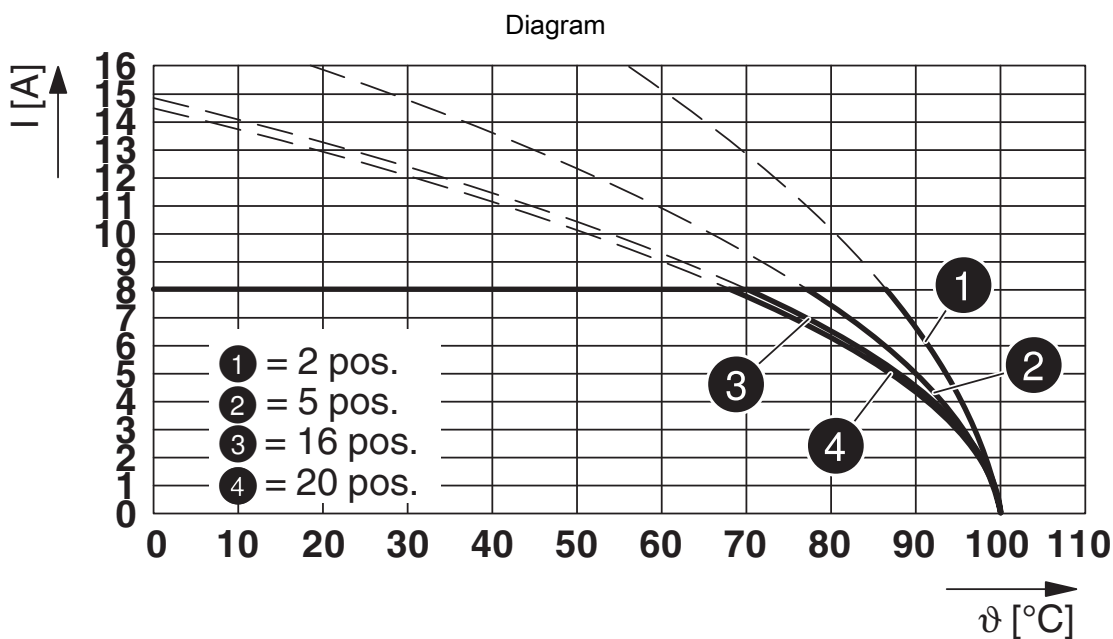

Type: FK-MCP 1,5/...-STF-3,5 with MCV 1,5/...-GF-3,5

# FK-MCP 1,5/ 3-STF-3,5 - PCB connector



1940101

<https://www.phoenixcontact.com/us/products/1940101>

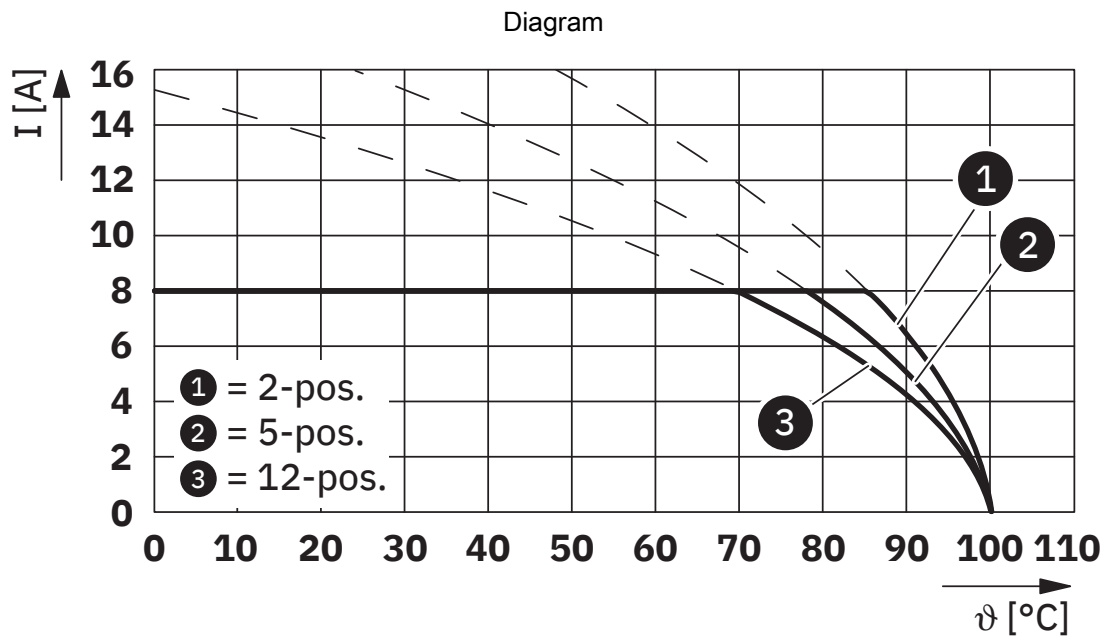

Type: FK-MCP 1,5/...-STF-3,5 with MC 1,5/...-GF-3,5 P... THR

# FK-MCP 1,5/ 3-STF-3,5 - PCB connector



1940101

<https://www.phoenixcontact.com/us/products/1940101>

## Approvals

To download certificates, visit the product detail page: <https://www.phoenixcontact.com/us/products/1940101>

 <b>cULus Recognized</b> Approval ID: E60425-19920306		Nominal voltage $U_N$	Nominal current $I_N$	Cross section AWG	Cross section $\text{mm}^2$
B		300 V	8 A	28 - 16	-
D		300 V	8 A	28 - 16	-

# FK-MCP 1,5/ 3-STF-3,5 - PCB connector



1940101

<https://www.phoenixcontact.com/us/products/1940101>

## Classifications

### ECLASS

ECLASS-13.0	27460202
ECLASS-15.0	27460202

### ETIM

ETIM 10.0	EC002638
-----------	----------

### UNSPSC

UNSPSC 21.0	39121400
-------------	----------

# FK-MCP 1,5/ 3-STF-3,5 - PCB connector



1940101

<https://www.phoenixcontact.com/us/products/1940101>

## Environmental product compliance

### EU RoHS

Fulfills EU RoHS substance requirements	Yes, No exemptions
---	--------------------

### China RoHS

Environment friendly use period (EFUP)	EFUP-E
	No hazardous substances above the limits

### EU REACH SVHC

REACH candidate substance (CAS No.)	No substance above 0.1 wt%
-------------------------------------	----------------------------

### EF3.1 Climate Change

CO2e kg	0.038 kg CO2e
---------	---------------

Phoenix Contact 2026 © - all rights reserved  
<https://www.phoenixcontact.com>

Phoenix Contact USA  
586 Fulling Mill Road  
Middletown, PA 17057, United States  
(+717) 944-1300  
[info@phoenixcon.com](mailto:info@phoenixcon.com)