

# FK-MPT 0,5/ 2-ST-3,5 - PCB connector



1913921

<https://www.phoenixcontact.com/us/products/1913921>

Please be informed that the data shown in this PDF document is generated from our online catalog. Please find the complete data in the user documentation. Our general terms of use for downloads are valid.

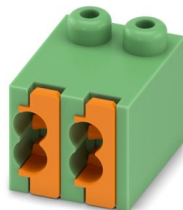

PCB connector, nominal cross section: 0.5 mm<sup>2</sup>, color: green, nominal current: 4 A, rated voltage (III/2): 250 V, contact surface: Sn, contact connection type: Socket, number of potentials: 2, number of rows: 1, number of positions: 2, number of connections: 4, product range: FK-MPT 0,5/..-ST, pitch: 3.5 mm, connection method: Push-in spring connection, conductor/PCB connection direction: 0 °, plug-in system: COMBICON PST 1,0, locking: without, mounting method: without, type of packaging: packed in cardboard

## Your advantages

- Time saving push-in connection, tools not required
- Defined contact force ensures that contact remains stable over the long term
- Intuitive operation due to color-coded actuating push button
- Potentials can be easily looped through – ideal for BUS applications
- Small component size for applications where space is at a premium

## Commercial data

Item number	1913921
Packing unit	50 pc
Minimum order quantity	50 pc
Sales key	AA01
Product key	AAAFBA
GTIN	4017918176839
Weight per piece (including packing)	0.87 g
Weight per piece (excluding packing)	0.52 g
Customs tariff number	85366990
Country of origin	IN

# FK-MPT 0,5/ 2-ST-3,5 - PCB connector



1913921

<https://www.phoenixcontact.com/us/products/1913921>

## Technical data

### Product properties

Product type	PCB connector
Product family	FK-MPT 0,5/...-ST
Product line	COMBICON Connectors XS
Type	Plug for pin strip
Number of positions	2
Pitch	3.5 mm
Number of connections	4
Number of rows	1
Number of potentials	2
Mounting type	without

### Electrical properties

#### Properties

Nominal current $I_N$	4 A
Nominal voltage $U_N$	250 V
Rated voltage (III/3)	160 V
Rated surge voltage (III/3)	2.5 kV
Rated voltage (III/2)	250 V
Rated surge voltage (III/2)	2.5 kV
Rated voltage (II/2)	250 V
Rated surge voltage (II/2)	2.5 kV

### Connection data

#### Interlock

Locking type	without
Mounting type	without

#### Conductor connection

Connection method	Push-in spring connection
Conductor/PCB connection direction	0 °
Conductor cross-section rigid	0.12 mm <sup>2</sup> ... 0.5 mm <sup>2</sup>
Conductor cross-section AWG	26 ... 20
Stripping length	6.5 mm

### Material specifications

#### Material data - contact

Note	WEEE/RoHS-compliant, free of whiskers according to IEC 60068-2-82/JEDEC JESD 201
Contact material	Cu alloy
Surface characteristics	hot-dip tin-plated

# FK-MPT 0,5/ 2-ST-3,5 - PCB connector

1913921

<https://www.phoenixcontact.com/us/products/1913921>

Metal surface terminal point (top layer)	Tin (5 µm - 7 µm Sn)
Metal surface terminal point (middle layer)	Nickel (2 µm - 3 µm Ni)
Metal surface contact area (top layer)	Tin (5 µm - 7 µm Sn)
Metal surface contact area (middle layer)	Nickel (2 µm - 3 µm Ni)

## Material data - housing

Color (Housing)	green (6021)
Insulating material	PBT
Insulating material group	IIIa
CTI according to IEC 60112	225
Flammability rating according to UL 94	V0

## Material data – actuating element

Color (Actuating element)	orange (2003)
---------------------------	---------------

## Dimensions

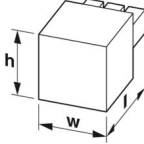
Dimensional drawing	
Pitch	3.5 mm
Width [w]	7.5 mm
Height [h]	8.5 mm
Length [l]	9.5 mm

## Environmental and real-life conditions

### Ambient conditions

Ambient temperature (storage/transport)	-40 °C ... 70 °C
Relative humidity (storage/transport)	30 % ... 70 %
Ambient temperature (assembly)	-5 °C ... 100 °C
Ambient temperature (operation)	-40 °C ... 100 °C (dependent on the derating curve)

## Electrical tests

### Air clearances and creepage distances |

Specification	IEC 60664-1:2007-04
Insulating material group	IIIa
Comparative tracking index (IEC 60112)	CTI 225
Rated insulation voltage (III/3)	160 V
Rated surge voltage (III/3)	2.5 kV
minimum clearance value - non-homogenous field (III/3)	1.5 mm
minimum creepage distance (III/3)	2.5 mm
Rated insulation voltage (III/2)	250 V

# FK-MPT 0,5/ 2-ST-3,5 - PCB connector



1913921

<https://www.phoenixcontact.com/us/products/1913921>

Rated surge voltage (III/2)	2.5 kV
minimum clearance value - non-homogenous field (III/2)	1.5 mm
minimum creepage distance (III/2)	2.5 mm
Rated insulation voltage (II/2)	250 V
Rated surge voltage (II/2)	2.5 kV
minimum clearance value - non-homogenous field (II/2)	1.5 mm
minimum creepage distance (II/2)	2.5 mm

## Packaging specifications

Type of packaging	packed in cardboard
-------------------	---------------------

# FK-MPT 0,5/ 2-ST-3,5 - PCB connector

1913921

<https://www.phoenixcontact.com/us/products/1913921>

## Drawings

Dimensional drawing



Diagram

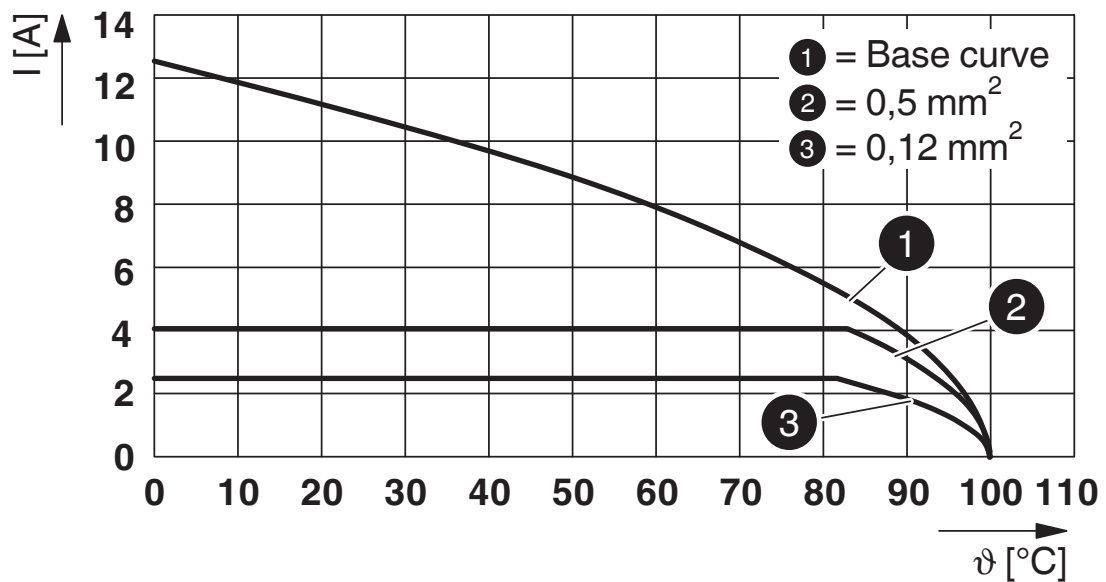

# FK-MPT 0,5/ 2-ST-3,5 - PCB connector



1913921

<https://www.phoenixcontact.com/us/products/1913921>

## Approvals

To download certificates, visit the product detail page: <https://www.phoenixcontact.com/us/products/1913921>

 <b>cULus Recognized</b> Approval ID: E60425-19991118				
	Nominal voltage $U_N$	Nominal current $I_N$	Cross section AWG	Cross section $mm^2$
B	300 V	4 A	28 - 20	-
D	300 V	4 A	28 - 20	-

 <b>VDE Gutachten mit Fertigungsüberwachung</b> Approval ID: 40040542				
	Nominal voltage $U_N$	Nominal current $I_N$	Cross section AWG	Cross section $mm^2$
keine	250 V	4 A	-	0.2 - 0.5

# FK-MPT 0,5/ 2-ST-3,5 - PCB connector



1913921

<https://www.phoenixcontact.com/us/products/1913921>

## Classifications

### ECLASS

ECLASS-13.0	27460202
ECLASS-15.0	27460202

### ETIM

ETIM 10.0	EC002638
-----------	----------

### UNSPSC

UNSPSC 21.0	39121400
-------------	----------

# FK-MPT 0,5/ 2-ST-3,5 - PCB connector



1913921

<https://www.phoenixcontact.com/us/products/1913921>

## Environmental product compliance

### EU RoHS

Fulfills EU RoHS substance requirements	Yes, No exemptions
---	--------------------

### China RoHS

Environment friendly use period (EFUP)	EFUP-E
	No hazardous substances above the limits

### EU REACH SVHC

REACH candidate substance (CAS No.)	No substance above 0.1 wt%
-------------------------------------	----------------------------

Phoenix Contact 2026 © - all rights reserved  
<https://www.phoenixcontact.com>

Phoenix Contact USA  
586 Fulling Mill Road  
Middletown, PA 17057, United States  
(+717) 944-1300  
[info@phoenixcon.com](mailto:info@phoenixcon.com)