

QC 0,5/11-ST-3,81 - PCB connector

1897487

<https://www.phoenixcontact.com/us/products/1897487>

Please be informed that the data shown in this PDF document is generated from our online catalog. Please find the complete data in the user documentation. Our general terms of use for downloads are valid.

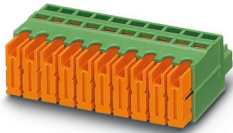

The figure shows a 10-position version of the product

PCB connector, nominal cross section: 0.5 mm², color: green, nominal current: 6 A, rated voltage (III/2): 200 V, contact surface: Sn, contact connection type: Socket, number of potentials: 11, number of rows: 1, number of positions: 11, number of connections: 11, product range: QC 0,5/..-ST, pitch: 3.81 mm, connection method: Displacement connection, conductor/PCB connection direction: 0 °, plug-in system: COMBICON MC 1,5, locking: without, mounting method: without, type of packaging: packed in cardboard

Your advantages

- Connection without conductor pretreatment for huge time savings
- Quick and convenient testing using integrated test option

Commercial data

Item number	1897487
Packing unit	50 pc
Minimum order quantity	50 pc
Note	Made to order (non-returnable)
Sales key	AA01
Product key	AAAQQA
GTIN	4017918164980
Weight per piece (including packing)	9.71 g
Weight per piece (excluding packing)	9.71 g
Customs tariff number	85366990
Country of origin	PL

QC 0,5/11-ST-3,81 - PCB connector



1897487

<https://www.phoenixcontact.com/us/products/1897487>

Technical data

Product properties

Product type	PCB connector
Product family	QC 0,5/...-ST
Product line	COMBICON Connectors S
Type	Standard
Number of positions	11
Pitch	3.81 mm
Number of connections	11
Number of rows	1
Number of potentials	11
Mounting type	without

Electrical properties

Properties

Nominal current I_N	6 A
Nominal voltage U_N	200 V
Rated voltage (III/3)	200 V
Rated surge voltage (III/3)	4 kV
Rated voltage (III/2)	200 V
Rated surge voltage (III/2)	4 kV
Rated voltage (II/2)	400 V
Rated surge voltage (II/2)	4 kV

Connection data

Connection technology

Type	Standard
Connector system	COMBICON MC 1,5
Nominal cross section	0.5 mm ²
Contact connection type	Socket

Interlock

Locking type	without
Mounting type	without

Conductor connection

Connection method	Displacement connection
Conductor/PCB connection direction	0 °
Conductor cross-section flexible	0.34 mm ² ... 0.5 mm ²
Conductor cross-section AWG	22 ... 20

Material specifications

QC 0,5/11-ST-3,81 - PCB connector

1897487

<https://www.phoenixcontact.com/us/products/1897487>

Material data - contact

Note	WEEE/RoHS-compliant, free of whiskers according to IEC 60068-2-82/JEDEC JESD 201
Contact material	Cu alloy
Surface characteristics	hot-dip tin-plated
Metal surface terminal point (top layer)	Tin (5 µm - 7 µm Sn)
Metal surface contact area (top layer)	Tin (5 µm - 7 µm Sn)

Material data - housing

Color (Housing)	green (6021)
Insulating material	PA
Insulating material group	I
CTI according to IEC 60112	600
Flammability rating according to UL 94	V0
Glow wire flammability index GWFI according to EN 60695-2-12	850
Glow wire ignition temperature GWIT according to EN 60695-2-13	775
Temperature for the ball pressure test according to EN 60695-10-2	125 °C

Material data – actuating element

Color (Actuating element)	orange (2003)
Insulating material	PA
Insulating material group	I
CTI according to IEC 60112	600
Flammability rating according to UL 94	V0
Glow wire flammability index GWFI according to EN 60695-2-12	850
Glow wire ignition temperature GWIT according to EN 60695-2-13	775
Temperature for the ball pressure test according to EN 60695-10-2	125 °C

Dimensions

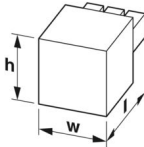
Dimensional drawing	
Pitch	3.81 mm
Width [w]	42.7 mm
Height [h]	12.9 mm
Length [l]	26.8 mm

Mechanical tests

Insertion and withdrawal forces

QC 0,5/11-ST-3,81 - PCB connector



1897487

<https://www.phoenixcontact.com/us/products/1897487>

Specification	IEC 60512-13-2:2006-02
Result	Test passed
No. of cycles	25
Insertion strength per pos. approx.	8 N
Withdraw strength per pos. approx.	6 N

Environmental and real-life conditions

Ambient conditions

Ambient temperature (storage/transport)	-40 °C ... 70 °C
Relative humidity (storage/transport)	30 % ... 70 %
Ambient temperature (assembly)	-5 °C ... 100 °C
Ambient temperature (operation)	-40 °C ... 100 °C (dependent on the derating curve)

Electrical tests

Air clearances and creepage distances |

Specification	IEC 60664-1:2007-04
Insulating material group	I
Comparative tracking index (IEC 60112)	CTI 600
Rated insulation voltage (III/3)	200 V
Rated surge voltage (III/3)	4 kV
minimum clearance value - non-homogenous field (III/3)	3 mm
minimum creepage distance (III/3)	3 mm
Rated insulation voltage (III/2)	200 V
Rated surge voltage (III/2)	4 kV
minimum clearance value - non-homogenous field (III/2)	3 mm
minimum creepage distance (III/2)	3 mm
Rated insulation voltage (II/2)	400 V
Rated surge voltage (II/2)	4 kV
minimum clearance value - non-homogenous field (II/2)	3 mm
minimum creepage distance (II/2)	3 mm

Packaging specifications

Type of packaging	packed in cardboard
-------------------	---------------------

QC 0,5/11-ST-3,81 - PCB connector

1897487

<https://www.phoenixcontact.com/us/products/1897487>



Drawings

Dimensional drawing

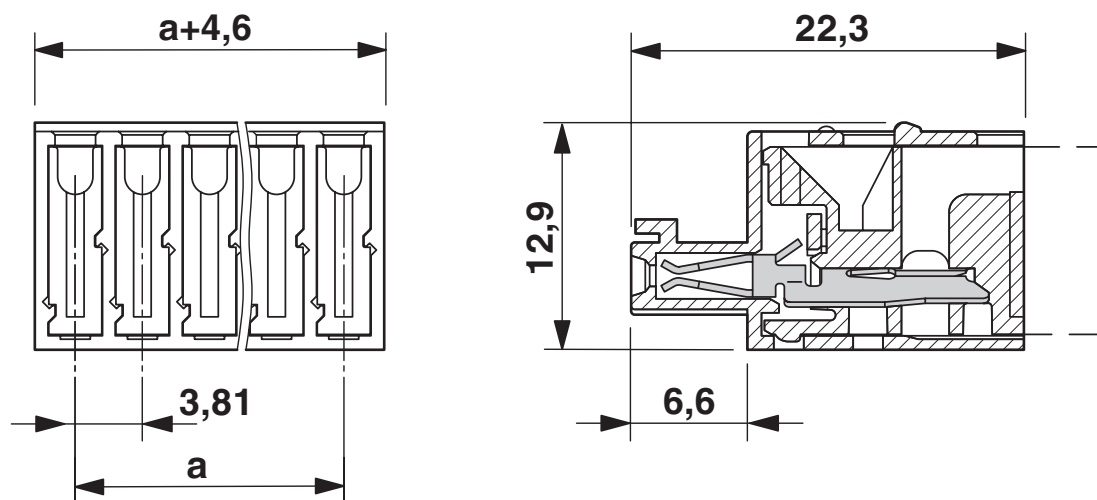

QC 0,5/11-ST-3,81 - PCB connector



1897487

<https://www.phoenixcontact.com/us/products/1897487>

Approvals

To download certificates, visit the product detail page: <https://www.phoenixcontact.com/us/products/1897487>

 cULus Recognized Approval ID: E60425-20010309				
	Nominal voltage U_N	Nominal current I_N	Cross section AWG	Cross section mm^2
B	300 V	6 A	24 - 20	-
C	300 V	6 A	24 - 20	-

 VDE Zeichengenehmigung Approval ID: 40011723				
	Nominal voltage U_N	Nominal current I_N	Cross section AWG	Cross section mm^2
keine	320 V	5 A	-	0.34 - 0.5

QC 0,5/11-ST-3,81 - PCB connector



1897487

<https://www.phoenixcontact.com/us/products/1897487>

Classifications

ECLASS

ECLASS-13.0	27460202
ECLASS-15.0	27460202

ETIM

ETIM 10.0	EC002638
-----------	----------

UNSPSC

UNSPSC 21.0	39121400
-------------	----------

QC 0,5/11-ST-3,81 - PCB connector



1897487

<https://www.phoenixcontact.com/us/products/1897487>

Environmental product compliance

EU RoHS

Fulfills EU RoHS substance requirements	Yes, No exemptions
---	--------------------

China RoHS

Environment friendly use period (EFUP)	EFUP-E
	No hazardous substances above the limits

EU REACH SVHC

REACH candidate substance (CAS No.)	No substance above 0.1 wt%
-------------------------------------	----------------------------

Phoenix Contact 2026 © - all rights reserved
<https://www.phoenixcontact.com>

Phoenix Contact USA
586 Fulling Mill Road
Middletown, PA 17057, United States
(+717) 944-1300
info@phoenixcon.com