

# QC 0,5/ 5-ST-3,81 - PCB connector

1897429

<https://www.phoenixcontact.com/us/products/1897429>

Please be informed that the data shown in this PDF document is generated from our online catalog. Please find the complete data in the user documentation. Our general terms of use for downloads are valid.

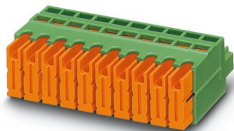
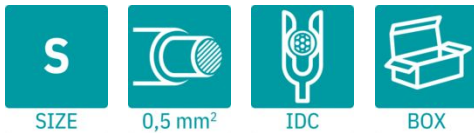

The figure shows a 10-position version of the product

PCB connector, nominal cross section: 0.5 mm<sup>2</sup>, color: green, nominal current: 6 A, rated voltage (III/2): 200 V, contact surface: Sn, contact connection type: Socket, number of potentials: 5, number of rows: 1, number of positions: 5, number of connections: 5, product range: QC 0,5/...-ST, pitch: 3.81 mm, connection method: Displacement connection, conductor/PCB connection direction: 0 °, plug-in system: COMBICON MC 1,5, locking: without, mounting method: without, type of packaging: packed in cardboard

## Your advantages

- Connection without conductor pretreatment for huge time savings
- Quick and convenient testing using integrated test option

## Commercial data

Item number	1897429
Packing unit	50 pc
Minimum order quantity	50 pc
Sales key	AA01
Product key	AAAQQA
GTIN	4017918164928
Weight per piece (including packing)	5.12 g
Weight per piece (excluding packing)	4.655 g
Customs tariff number	85366990
Country of origin	CN

# QC 0,5/ 5-ST-3,81 - PCB connector



1897429

<https://www.phoenixcontact.com/us/products/1897429>

## Technical data

### Product properties

Product type	PCB connector
Product family	QC 0,5/...-ST
Product line	COMBICON Connectors S
Type	Standard
Number of positions	5
Pitch	3.81 mm
Number of connections	5
Number of rows	1
Number of potentials	5
Mounting type	without

### Electrical properties

#### Properties

Nominal current $I_N$	6 A
Nominal voltage $U_N$	200 V
Rated voltage (III/3)	200 V
Rated surge voltage (III/3)	4 kV
Rated voltage (III/2)	200 V
Rated surge voltage (III/2)	4 kV
Rated voltage (II/2)	400 V
Rated surge voltage (II/2)	4 kV

### Connection data

#### Connection technology

Type	Standard
Connector system	COMBICON MC 1,5
Nominal cross section	0.5 mm <sup>2</sup>
Contact connection type	Socket

#### Interlock

Locking type	without
Mounting type	without

#### Conductor connection

Connection method	Displacement connection
Conductor/PCB connection direction	0 °
Conductor cross-section flexible	0.34 mm <sup>2</sup> ... 0.5 mm <sup>2</sup>
Conductor cross-section AWG	22 ... 20

### Material specifications

# QC 0,5/ 5-ST-3,81 - PCB connector

1897429

<https://www.phoenixcontact.com/us/products/1897429>

## Material data - contact

Note	WEEE/RoHS-compliant, free of whiskers according to IEC 60068-2-82/JEDEC JESD 201
Contact material	Cu alloy
Surface characteristics	hot-dip tin-plated
Metal surface terminal point (top layer)	Tin (5 µm - 7 µm Sn)
Metal surface contact area (top layer)	Tin (5 µm - 7 µm Sn)

## Material data - housing

Color (Housing)	green (6021)
Insulating material	PA
Insulating material group	I
CTI according to IEC 60112	600
Flammability rating according to UL 94	V0
Glow wire flammability index GWFI according to EN 60695-2-12	850
Glow wire ignition temperature GWIT according to EN 60695-2-13	775
Temperature for the ball pressure test according to EN 60695-10-2	125 °C

## Material data – actuating element

Color (Actuating element)	orange (2003)
Insulating material	PA
Insulating material group	I
CTI according to IEC 60112	600
Flammability rating according to UL 94	V0
Glow wire flammability index GWFI according to EN 60695-2-12	850
Glow wire ignition temperature GWIT according to EN 60695-2-13	775
Temperature for the ball pressure test according to EN 60695-10-2	125 °C

## Dimensions

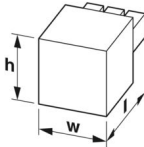
Dimensional drawing	
Pitch	3.81 mm
Width [w]	19.84 mm
Height [h]	12.9 mm
Length [l]	26.8 mm

## Mechanical tests

Insertion and withdrawal forces

# QC 0,5/ 5-ST-3,81 - PCB connector



1897429

<https://www.phoenixcontact.com/us/products/1897429>

Specification	IEC 60512-13-2:2006-02
Result	Test passed
No. of cycles	25
Insertion strength per pos. approx.	8 N
Withdraw strength per pos. approx.	6 N

## Environmental and real-life conditions

### Ambient conditions

Ambient temperature (storage/transport)	-40 °C ... 70 °C
Relative humidity (storage/transport)	30 % ... 70 %
Ambient temperature (assembly)	-5 °C ... 100 °C
Ambient temperature (operation)	-40 °C ... 100 °C (dependent on the derating curve)

## Electrical tests

### Air clearances and creepage distances |

Specification	IEC 60664-1:2007-04
Insulating material group	I
Comparative tracking index (IEC 60112)	CTI 600
Rated insulation voltage (III/3)	200 V
Rated surge voltage (III/3)	4 kV
minimum clearance value - non-homogenous field (III/3)	3 mm
minimum creepage distance (III/3)	3 mm
Rated insulation voltage (III/2)	200 V
Rated surge voltage (III/2)	4 kV
minimum clearance value - non-homogenous field (III/2)	3 mm
minimum creepage distance (III/2)	3 mm
Rated insulation voltage (II/2)	400 V
Rated surge voltage (II/2)	4 kV
minimum clearance value - non-homogenous field (II/2)	3 mm
minimum creepage distance (II/2)	3 mm

## Packaging specifications

Type of packaging	packed in cardboard
-------------------	---------------------

# QC 0,5/ 5-ST-3,81 - PCB connector

1897429

<https://www.phoenixcontact.com/us/products/1897429>



## Drawings

### Dimensional drawing

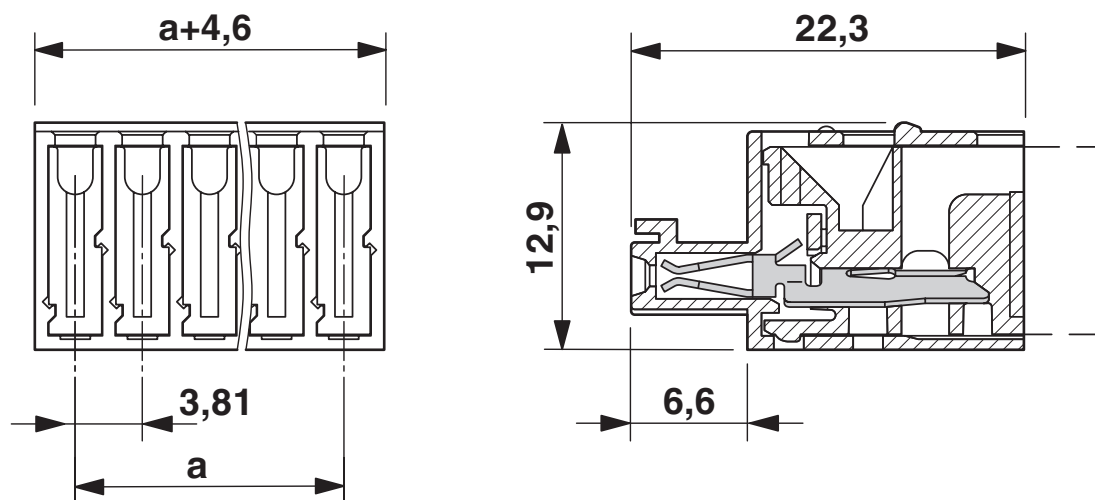

# QC 0,5/ 5-ST-3,81 - PCB connector



1897429

<https://www.phoenixcontact.com/us/products/1897429>

## Approvals

To download certificates, visit the product detail page: <https://www.phoenixcontact.com/us/products/1897429>

 <b>cULus Recognized</b> Approval ID: E60425-20010309				
	Nominal voltage $U_N$	Nominal current $I_N$	Cross section AWG	Cross section $\text{mm}^2$
B	300 V	6 A	24 - 20	-
C	300 V	6 A	24 - 20	-

 <b>VDE Zeichengenehmigung</b> Approval ID: 40011723				
	Nominal voltage $U_N$	Nominal current $I_N$	Cross section AWG	Cross section $\text{mm}^2$
keine	320 V	5 A	-	0.34 - 0.5

# QC 0,5/ 5-ST-3,81 - PCB connector



1897429

<https://www.phoenixcontact.com/us/products/1897429>

## Classifications

### ECLASS

ECLASS-13.0	27460202
ECLASS-15.0	27460202

### ETIM

ETIM 10.0	EC002638
-----------	----------

### UNSPSC

UNSPSC 21.0	39121400
-------------	----------

# QC 0,5/ 5-ST-3,81 - PCB connector



1897429

<https://www.phoenixcontact.com/us/products/1897429>

## Environmental product compliance

### EU RoHS

Fulfills EU RoHS substance requirements	Yes, No exemptions
---	--------------------

### China RoHS

Environment friendly use period (EFUP)	EFUP-E
	No hazardous substances above the limits

### EU REACH SVHC

REACH candidate substance (CAS No.)	No substance above 0.1 wt%
-------------------------------------	----------------------------

### EF3.1 Climate Change

CO2e kg	0.164 kg CO2e
---------	---------------

Phoenix Contact 2026 © - all rights reserved  
<https://www.phoenixcontact.com>

Phoenix Contact USA  
586 Fulling Mill Road  
Middletown, PA 17057, United States  
(+717) 944-1300  
[info@phoenixcon.com](mailto:info@phoenixcon.com)